



This is a digital copy of a book that was preserved for generations on library shelves before it was carefully scanned by Google as part of a project to make the world's books discoverable online.

It has survived long enough for the copyright to expire and the book to enter the public domain. A public domain book is one that was never subject to copyright or whose legal copyright term has expired. Whether a book is in the public domain may vary country to country. Public domain books are our gateways to the past, representing a wealth of history, culture and knowledge that's often difficult to discover.

Marks, notations and other marginalia present in the original volume will appear in this file - a reminder of this book's long journey from the publisher to a library and finally to you.

Usage guidelines

Google is proud to partner with libraries to digitize public domain materials and make them widely accessible. Public domain books belong to the public and we are merely their custodians. Nevertheless, this work is expensive, so in order to keep providing this resource, we have taken steps to prevent abuse by commercial parties, including placing technical restrictions on automated querying.

We also ask that you:

- + *Make non-commercial use of the files* We designed Google Book Search for use by individuals, and we request that you use these files for personal, non-commercial purposes.
- + *Refrain from automated querying* Do not send automated queries of any sort to Google's system: If you are conducting research on machine translation, optical character recognition or other areas where access to a large amount of text is helpful, please contact us. We encourage the use of public domain materials for these purposes and may be able to help.
- + *Maintain attribution* The Google "watermark" you see on each file is essential for informing people about this project and helping them find additional materials through Google Book Search. Please do not remove it.
- + *Keep it legal* Whatever your use, remember that you are responsible for ensuring that what you are doing is legal. Do not assume that just because we believe a book is in the public domain for users in the United States, that the work is also in the public domain for users in other countries. Whether a book is still in copyright varies from country to country, and we can't offer guidance on whether any specific use of any specific book is allowed. Please do not assume that a book's appearance in Google Book Search means it can be used in any manner anywhere in the world. Copyright infringement liability can be quite severe.

About Google Book Search

Google's mission is to organize the world's information and to make it universally accessible and useful. Google Book Search helps readers discover the world's books while helping authors and publishers reach new audiences. You can search through the full text of this book on the web at <http://books.google.com/>

THE MANUFACTURE
OF SUGAR FROM THE
CANE AND BEET

T. H. P. HERIOT



EX LIBRIS

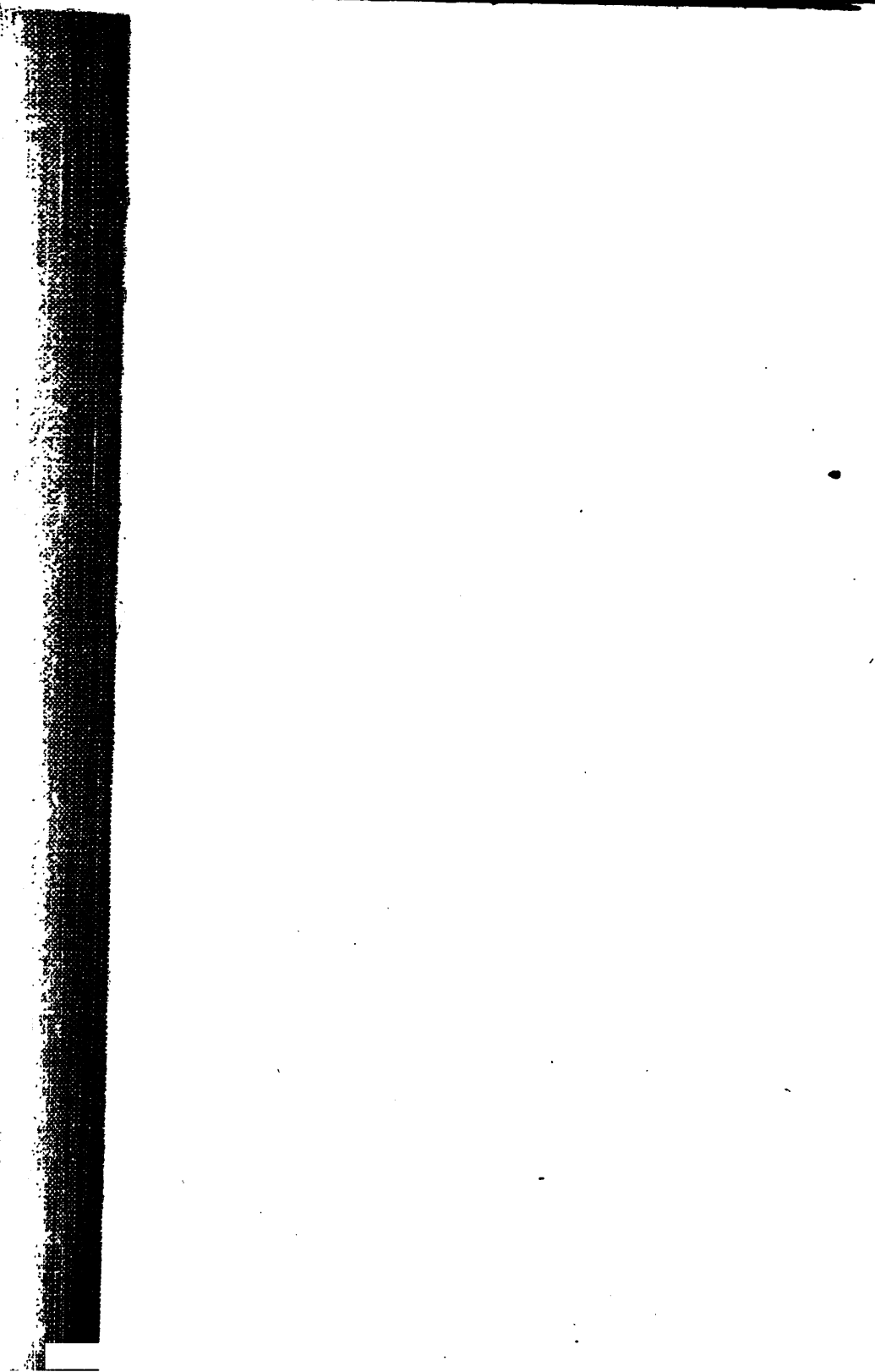

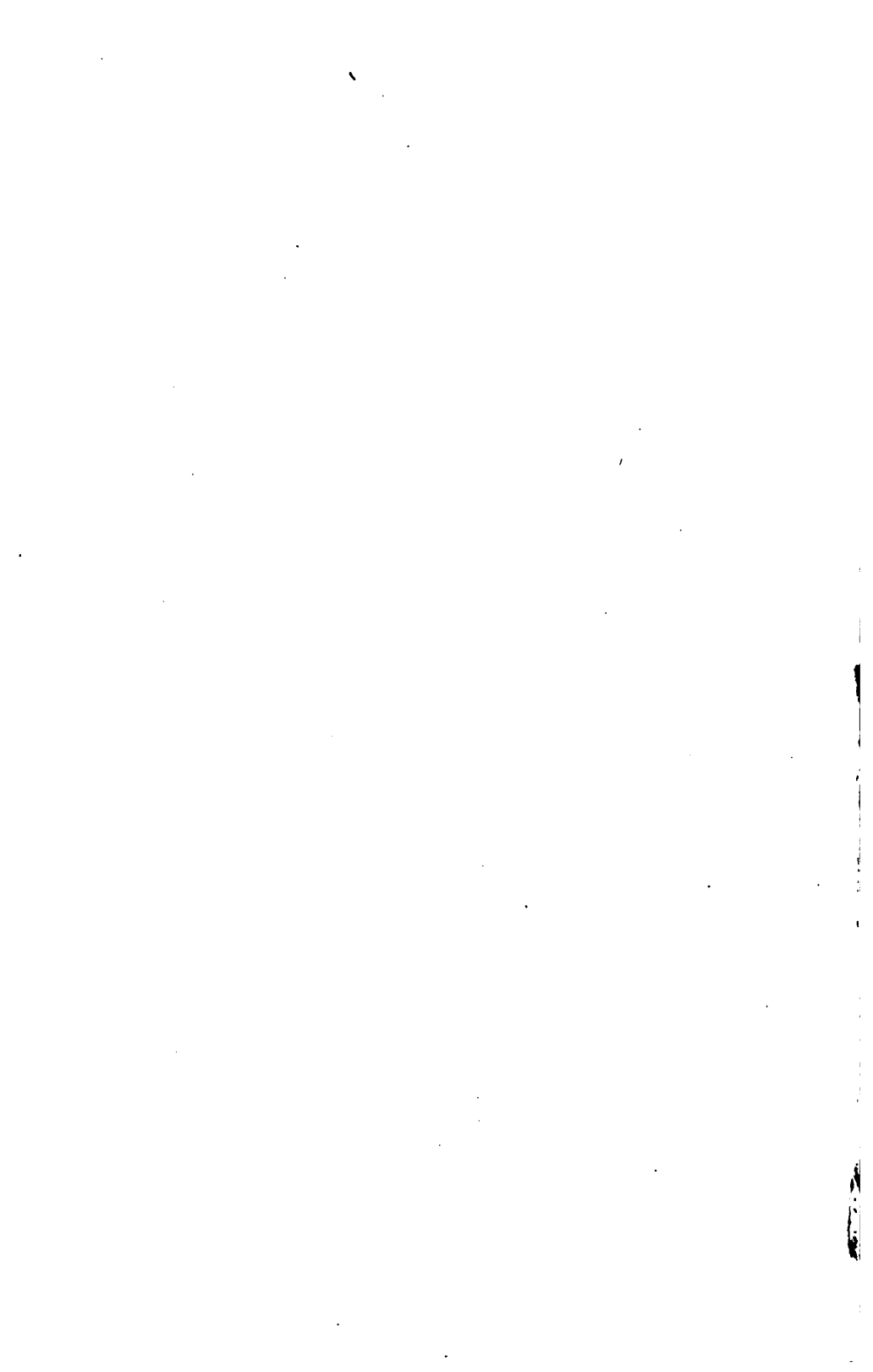

MONOGRAPHS ON INDUSTRIAL CHEMISTRY

Edited by Sir EDWARD THORPE, C.B., LL.D., F.R.S.

Emeritus Professor of General Chemistry in the Imperial College of Science and Technology South Kensington; and formerly Principal of the Government Laboratory, London.

INTRODUCTION

DURING the last four or five decades the Applications of Chemistry have experienced an extraordinary development, and there is scarcely an industry that has not benefited, directly or indirectly, from this expansion. Indeed, the Science trenches in greater or less degree upon all departments of human activity. Practically every division of Natural Science has now been linked up with it in the common service of mankind. So ceaseless and rapid is this expansion that the recondite knowledge of one generation becomes a part of the technology of the next. Thus the conceptions of chemical dynamics of one decade become translated into the current practice of its successor; the doctrines concerning chemical structure and constitution of one period form the basis of large-scale synthetical processes of another; an obscure phenomenon like Catalysis is found to be capable of widespread application in manufacturing operations of the most diverse character.

This series of Monographs will afford illustrations of these and similar facts, and incidentally indicate their bearing on the trend of industrial chemistry in the near future. They will serve to show how fundamental and essential is the relation of principle to practice. They will afford examples of the application of recent knowledge to modern manufacturing procedure. As regards their scope, it should be stated the books are not intended to cover the whole ground of the technology of the matters to which they relate. They are not concerned with the technical *minutiae* of manufacture except in so far as these may be necessary to elucidate some point of principle. In

some cases, where the subjects touch the actual frontiers of progress, knowledge is so very recent and its application so very tentative that both are almost certain to experience profound modification sooner or later. This, of course, is inevitable. But even so such books have more than an ephemeral interest. They are valuable as indicating new and only partially occupied territory; and as illustrating the vast potentiality of fruitful conceptions and the worth of general principles which have shown themselves capable of useful service.

Organic Compounds of Arsenic and Antimony. By GILBERT T. MORGAN, O.B.E., D.Sc., F.R.S., F.I.C., M.R.I.A., A.R.C.Sc., Professor of Chemistry in the University of Birmingham.

Edible Oils and Fats. By C. AINSWORTH MITCHELL, B.A., F.I.C.
Coal and its Scientific Uses. By WILLIAM A. BONE, D.Sc., Ph.D., F.R.S., Professor of Chemical Technology in the Imperial College of Science and Technology, London.

The Zinc Industry. By ERNEST A. SMITH, Assoc. R.S.M., Deputy Assay Master, Sheffield.

Colour in Relation to Chemical Constitution. By E. R. WATSON, M.A., D.Sc., Professor of Chemistry, Dacca College, Bengal.

The Applications of Electrolysis in Chemical Industry. By ARTHUR J. HALE, B.Sc., F.I.C., Demonstrator and Lecturer in Chemistry, The City and Guilds of London Technical College, Finsbury.

Catalysis in Industrial Chemistry. By G. G. HENDERSON, M.A., D.Sc., LL.D., F.R.S., Regius Professor of Chemistry in the University of Glasgow.

The Natural Organic Colouring Matters. By ARTHUR GEORGE PERKIN, F.R.S., F.R.S.E., F.I.C., Professor of Colour Chemistry and Dyeing in the University of Leeds; and ARTHUR ERNEST EVEREST, D.Sc., Ph.D., F.I.C., of the Wilton Research Laboratories.

Cement. By BERTRAM BLOUNT, F.I.C., assisted by WILLIAM H. WOODCOCK, F.C.S., Memb. Soc. Pub. Anal., and HENRY J. GILLET.

Plantation Rubber and the Testing of Rubber. By G. STAFFORD WHITBY, M.Sc., A.R.C.Sc., McGill University, Canada; formerly Chemist to the Société Financière des Caoutchoucs.

Margarine. By WILLIAM CLAYTON, M.Sc., A.I.C., Member of the British Association Committee on "Colloid Chemistry and its General and Industrial Applications."

The Manufacture of Sugar from the Cane and Beet. By T. H. P. HERIOT, F.I.C., Lecturer on Sugar Technology at the Royal Technical College, Glasgow.

The Electric Arc in Chemical Industry. By J. N. PRING, D.Sc., Reader in Electro-Metallurgy in the University of Manchester.

MONOGRAPHS ON INDUSTRIAL CHEMISTRY
EDITED BY SIR EDWARD THORPE, C.B., LL.D., F.R.S.

THE MANUFACTURE OF SUGAR
FROM THE CANE AND BEET

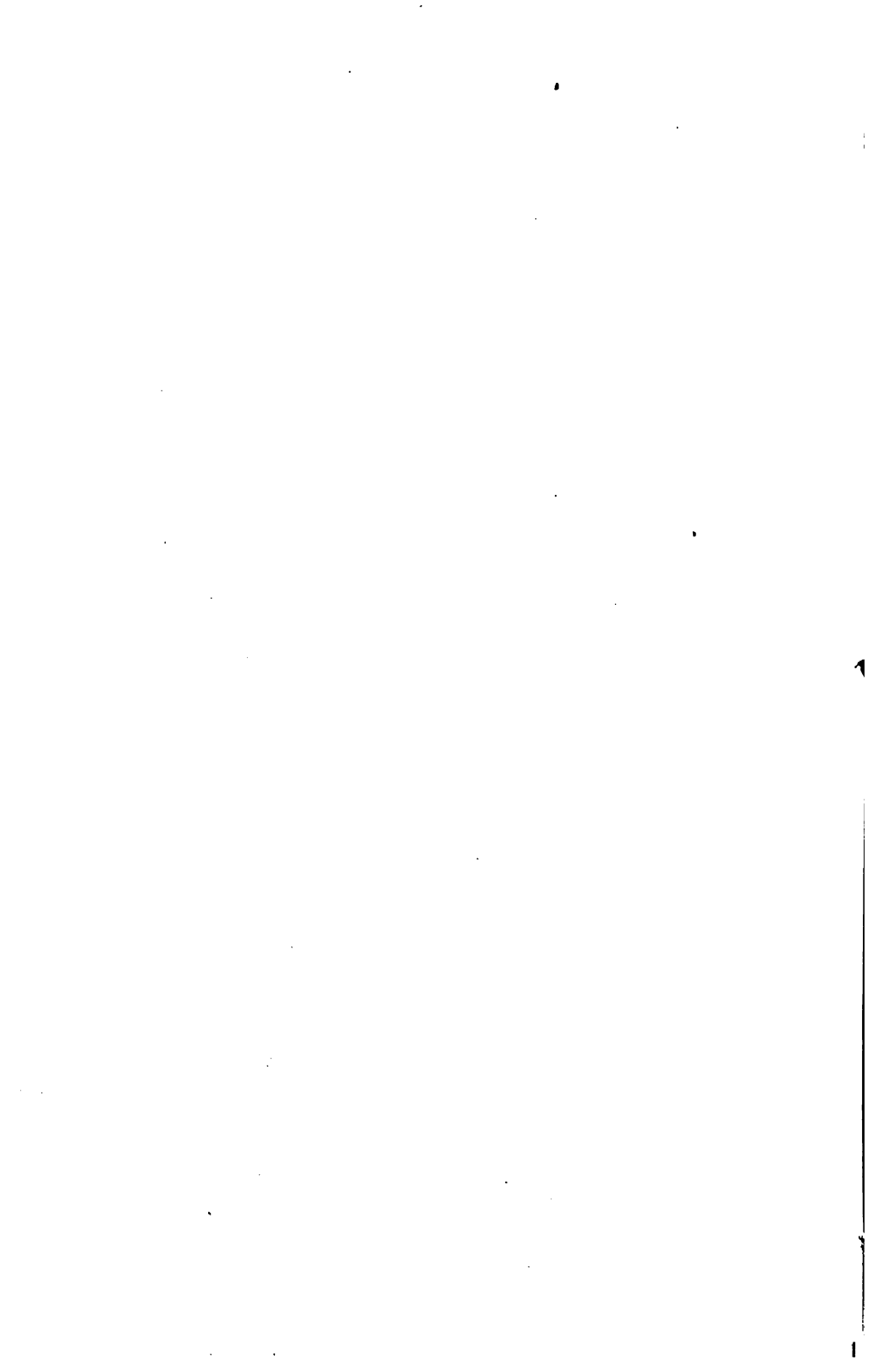

UNIV. OF
CALIFORNIA



SUGAR CANE.
(Messrs. Duncan, Stewart & Co., Ltd., Glasgow.)

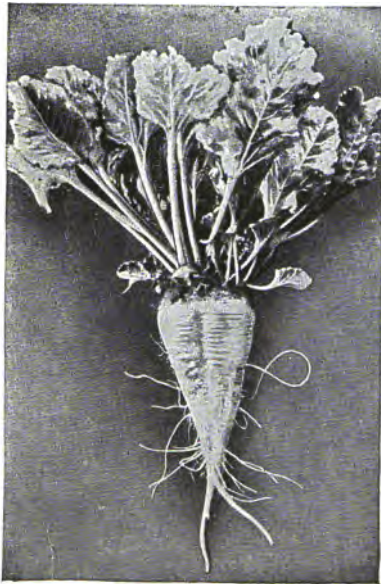

SUGAR BEETS.
(Messrs. John Wiley & Sons, New York.)

THE MANUFACTURE OF SUGAR FROM THE CANE AND BEET

F. H. P. H. & C.

MANUFACTURERS OF SUGAR FROM THE CANE AND BEET
AND ALL KINDS OF SUGAR

WITH FULL ILLUSTRATIONS

LONGMANS, GREEN AND CO.

39, PATERNOSTER ROW, LONDON

SOLE AGENTS FOR THE STRAITS SETTLEMENTS

AND ALL THE EAST AND WEST INDIES

1899

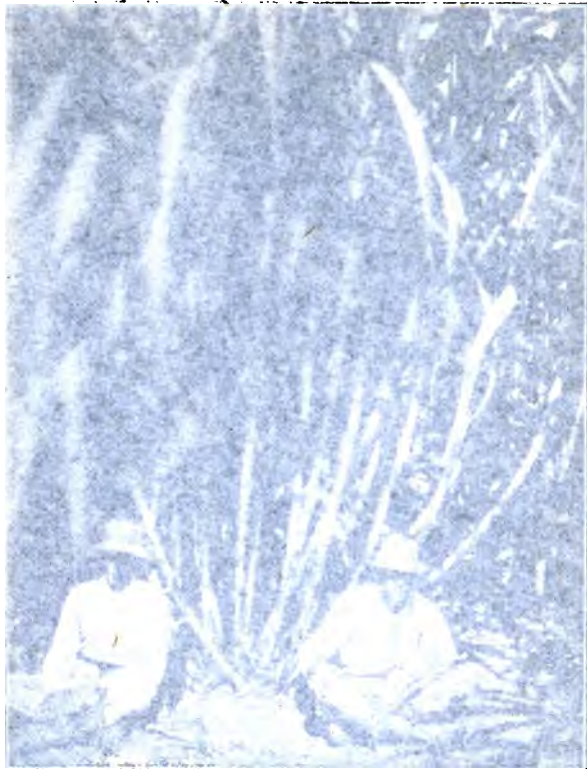

Men cutting sugar cane in the West Indies.

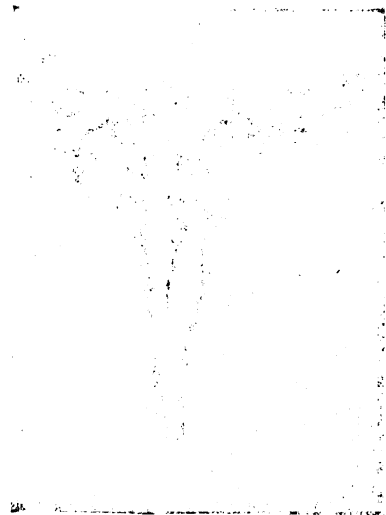
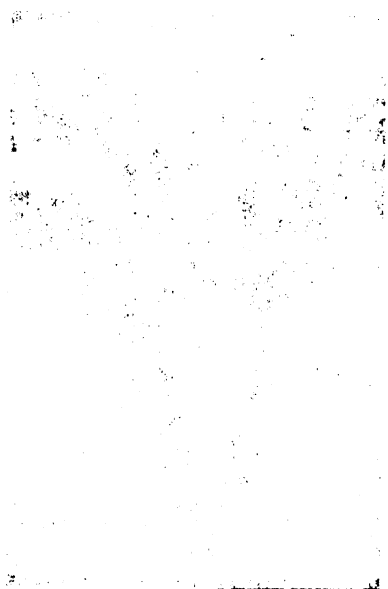

SUGAR BEETS.

1. Sugar beets in the West Indies, near Pinar.

THE MANUFACTURE OF SUGAR FROM THE CANE AND BEET

BY

T. H. P. HERIOT, F.I.C.

LECTURER ON SUGAR TECHNOLOGY AT THE ROYAL TECHNICAL COLLEGE, GLASGOW
AUTHOR OF "SCIENCE IN SUGAR PRODUCTION"

WITH ILLUSTRATIONS

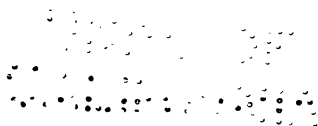

LONGMANS, GREEN AND CO.

39 PATERNOSTER ROW, LONDON

FOURTH AVENUE & 30TH STREET, NEW YORK

BOMBAY, CALCUTTA, AND MADRAS

1920

TP377
H48

TO THE
LIBRARY

PREFACE

IT has often been stated that the sugar producer can only be trained in the factory, theoretical knowledge being of little value. The aim of the present work is to show that successful practice is becoming more and more dependent on scientific principles, which can be studied more effectively outside the factory than inside.

It is worth recording that the British cane-sugar producer followed the beet-sugar producer in adopting the following inventions and processes¹:—Bone-char and sulphur dioxide, for bleaching the juice; the Carbonatation Process, for purifying and clarifying the juice; the Diffusion Process, for extracting sugar from the plant; the filter press; the multiple-effect evaporator *in vacuo*; the vacuum pan; apparatus for crystallisation-in-motion; the use of "seed-grain" in the vacuum pan; the centrifugal machine for curing sugar; the centrifugal machine for clarifying juice; technical schools for the study of sugar-technology; and "chemical control" of manufacturing operations.

The French cane-sugar industry led the way in systematic experiments in manuring of the cane; experiments on extraction of juice by milling; the invention of "shredders," to increase the mill-extraction; and the diffusion of sliced cane.

The British cane-sugar producer is probably not aware that his "up-to-date" factory is borrowed from his rival, for he shows little or no interest in the problems of beet-sugar manufacture. The student of sugar-technology should have a wider outlook, and keep in touch with all branches of sugar-production, although he can only hope to specialise in one. The present work will enable him to study the two industries

¹ See Noël Deerr's *A Brief Sketch of Discovery and Invention in the Sugar Industry*.

side by side; to note the progress made in each; and the differences in practice which have arisen from differences in the raw materials treated, although the same substance is extracted.

The two industries are treated in separate Parts, or in separate Chapters; enabling the reader to follow the consecutive operations in one industry, if he so desires; the Table of Contents being a sufficient guide. Additional Parts deal with the by-products of the two industries, and the refining of sugar. Other sugar-producing plants are briefly described.

The cost of the book has been reduced, as far as possible, by omitting detailed descriptions of sugar-machinery, and by employing only such illustrations as are essential to explain the text. Full references are made to other works where the omitted details can be found.

The author is indebted to the following gentlemen:—To Dr. H. C. Prinsen Geerligs for permission to reproduce Schemes 1, 2, and 3 opposite p. 314, and Table VI on p. 151. To Mr. W. R. Chisholm (*Royal Technical College, Glasgow*) for his kind assistance in preparing line-drawings of eleven original diagrams. To the following gentlemen for reading certain sections of the proofs and offering useful suggestions:—Mr. Andrew Robertson (*Messrs. Watson, Laidlaw & Co., Ltd.*); Mr. Thomas Wishart (*Messrs. Duncan, Stewart & Co., Ltd.*); Mr. James Harvey (*The Harvey Engineering Co., Ltd.*); and Mr. W. J. Buchanan (*Royal Technical College, Glasgow*).

The author also thanks the following firms for the loan of blocks and diagrams:—The Mirrlees Watson Co., Ltd., for Figs. 6, 7, 9, 27, and 28; Messrs. Blair, Campbell, McLean & Co., Ltd., for Figs. 8, 29, 35, and 36; The Harvey Engineering Co., Ltd., for Fig. 24; Messrs. Duncan, Stewart & Co., Ltd., for Fig. 19 and Frontispiece (sugar-cane); Messrs. Watson, Laidlaw & Co., Ltd., for Fig. 33; and Messrs. Longmans, Green & Co., for Figs. 3, 18, 37, 38, and 39.

T. H. P. HERIOT.

*The Royal Technical College,
Glasgow.*

CONTENTS

CHAP.	PART I.—THE RAW MATERIALS	PAGE
I.	THE MANUFACTURE OF SUGAR BY PLANTS	3
II.	THE SUGAR-BEET	10
III.	THE SUGAR-CANE	19
IV.	OTHER SUGAR-PRODUCING PLANTS	28
PART II.—EXTRACTION OF JUICE FROM THE CANE		
V.	PRINCIPLES OF THE MILLING PROCESS	35
VI.	MILLING MACHINERY, AND MODE OF OPERATING	44
VII.	CAPACITY AND EFFICIENCY OF MILLS	55
VIII.	OTHER METHODS OF JUICE-EXTRACTION	66
PART III.—EXTRACTION OF SUGAR FROM THE BEET		
IX.	PRINCIPLES OF THE DIFFUSION PROCESS	75
X.	APPARATUS USED FOR DIFFUSION	80
XI.	OPERATING THE DIFFUSION BATTERY, AND EFFICIENCY OF EXTRACTION	89
PART IV.—COMPOSITION OF CANE AND BEET JUICES		
XII.	INTRODUCTION—PROPERTIES OF THE SUGARS	105
XIII.	COMPOSITION OF THE CANE, AND EXTRACTED JUICE	126
XIV.	COMPOSITION OF THE BEET, AND EXTRACTED JUICE	138
XV.	INFORMATION OBTAINED BY ANALYSIS	144

PART V.—TREATMENT OF CANE AND BEET JUICES		PAGE
CHAP.		
XVI.	CHEMICAL AGENTS USED, AND METHODS OF HEATING THE JUICE	159
XVII.	CHEMICAL TREATMENT OF CANE JUICE	179
XVIII.	SEPARATION OF THE PRECIPITATE	201
XIX.	CHEMICAL TREATMENT OF BEET JUICE	227
PART VI.—EVAPORATION OF WATER FROM THE JUICE		
XX.	DEFINITIONS — PRINCIPLES OF MULTIPLE-EFFECT EVAPORATION	243
XXI.	TYPES OF EVAPORATORS USED, AND MODE OF OPERATING—EFFICIENCY	254
PART VII.—CRYSTALLISATION		
XXII.	CRYSTALLINE FORMS—FORMATION AND GROWTH OF CRYSTALS	275
XXIII.	CRYSTALLISATION DURING BOILING IN THE VACUUM PAN	280
XXIV.	CRYSTALLISATION DURING COOLING AT REST, AND IN MOTION	287
XXV.	SEPARATION OF THE CRYSTALS FROM THE MOTHER-LIQUOR—DRYING THE CRYSTALS	293
XXVI.	COMPLETE CRYSTALLISATION—CONTROL TESTS	308
XXVII.	EFFICIENCY OF CRYSTALLISING OPERATIONS	321
PART VIII.—SPECIAL METHODS OF EXTRACTING SUGAR FROM MOLASSES		
XXVIII.	TREATMENT OF BEET-MOLASSES	333
PART IX.—BY-PRODUCTS		
XXIX.	BY-PRODUCTS OF THE CANE-SUGAR FACTORY	345
XXX.	BY-PRODUCTS OF THE BEET-SUGAR FACTORY	372
PART X.—REFINING OF CANE AND BEET SUGARS		
XXXI.	AFFINING, MELTING, FILTERING, AND BLEACHING	387
XXXII.	CRYSTALLISATION AND BY-PRODUCTS	401
	INDEX	413

LIST OF ILLUSTRATIONS

FIG.		PAGE
	Sugar-cane and sugar-beet	<i>Frontispiece</i>
1.	Forage-beet	11
2.	Sugar-beet	11
3.	Sugar-cane	20
4.	Cane-stem, showing buds	20
5.	Diagram of nine-roller mill	35
6.	Vertical section of three-roller mill	45
7.	Krajewski-crusher and first mill-unit	<i>Facing</i> 46
8.	Eleven-roller mill, with gearing and one engine	" 46
9.	Fourteen-roller mill	" 46
10.	Messchaert-grooving of rollers (vertical section)	49
11.	" " " (longitudinal section)	49
12.	Hind-Renton-grooving of rollers (longitudinal section)	50
13.	Plan of circular diffusion-battery (work starting)	78
14.	" " " " (tenth diffuser in action)	78
15.	Sectional view of circular diffusion-battery	83
16.	Water entering tail-diffuser No. 1, and normal circulation in diffuser No. 2	90
17.	Drawing off diffusion-juice from diffuser No. 12, and filling diffuser No. 13	90
18.	Taylor bag-filter	209
19.	Filter-press (partly opened)	<i>Facing</i> 214
20.	Flow of juice during filtration	215
21.	Flow of water during washing of cakes	215
22.	Centrifugal-subsider	224
23.	Double-effect evaporator (vertical section)	248
24.	Triple-effect evaporator, with condenser and pump	<i>Facing</i> 250
25.	Lillie film evaporator (vertical section of one vessel)	256
26.	The Lillie quadruple-effect evaporator	257
27.	Coil-pan	262
28.	Calandria-pan	263

LIST OF ILLUSTRATIONS

FIG.		PAGE
29.	Vacuum pan, with condenser and pump <i>Facing</i>	360
30.	Plan of vacuum pan heated by juice-steam from first vessel of triple-effect evaporator	265
31.	Linear velocity	294
32.	Angular velocity	294
33.	Vertical section of sugar-centrifugal	297
34.	Brasmoscope, or brixometer	316
35.	Pot still, with retort and condenser <i>Facing</i>	360
36.	Coffey's continuous still "	362
37.	Char pipe-kiln	396
38.	Plan and elevation of liquor-department of refinery	398
39.	Hersey cube-sugar machine	405

PART I

THE RAW MATERIALS

- CHAPTER 1. THE MANUFACTURE OF SUGAR BY PLANTS
- „ 2. THE SUGAR-BEET
- „ 3. THE SUGAR-CANE
- „ 4. OTHER SUGAR-PRODUCING PLANTS

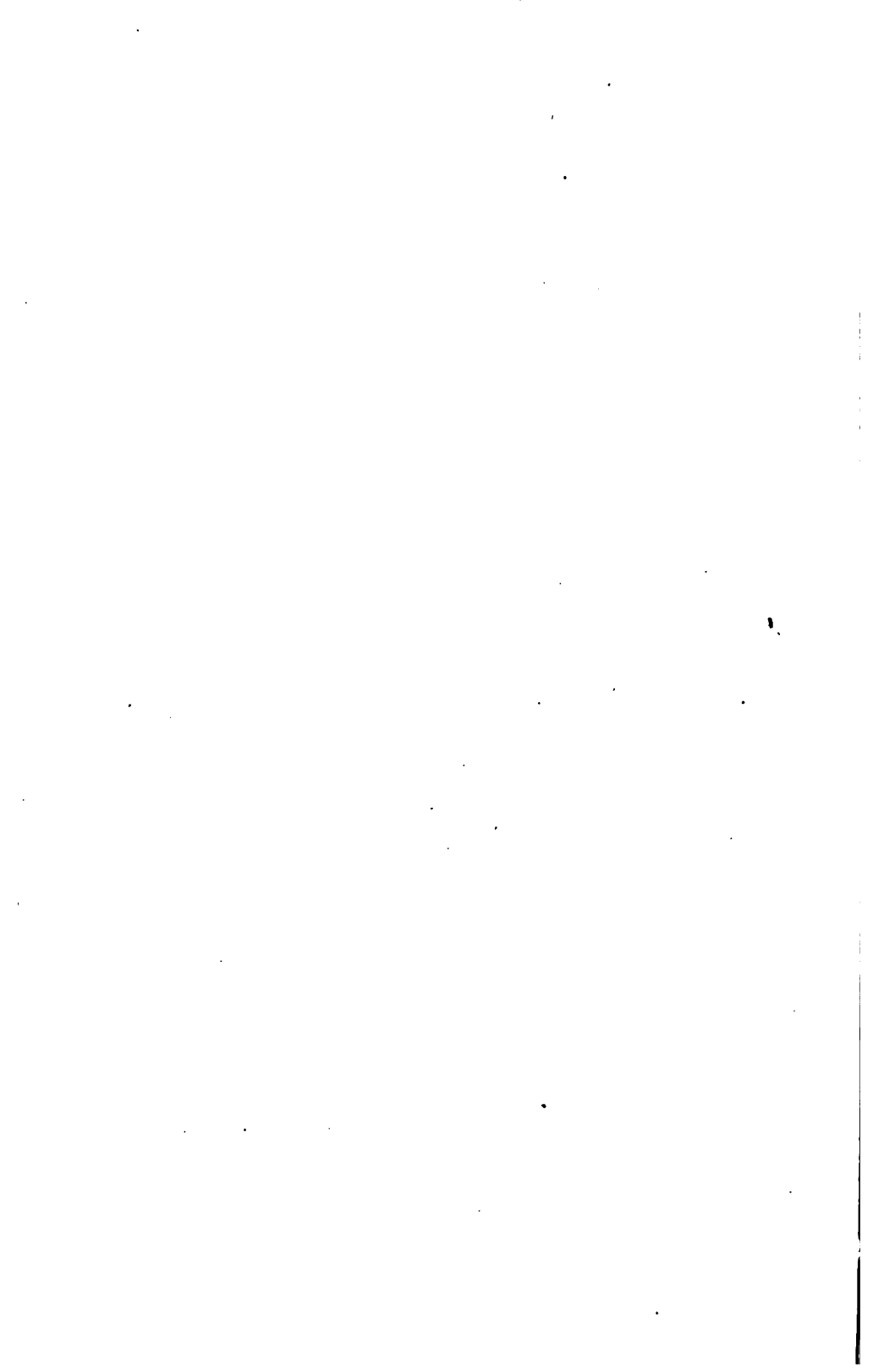

CHAPTER I

THE MANUFACTURE OF SUGAR BY PLANTS

SUGAR is manufactured by many plants, for their own use, for the sugar can be transformed into other substances, such as fibre, during vegetative growth. Being dissolved in the sap or juice, it can pass through the plant to those portions where growth is taking place.

A few plants also store sugar for future use, such as seed-production or new growth in the following year, and this stored-up sugar can be extracted and purified in the sugar factory.

The term "sugar" applies to a large number of substances, composed of three elements—carbon, hydrogen, and oxygen, combined in certain proportions. Many sugars occur in Nature, namely in plants and animals; whilst others, not yet found in Nature, have been produced synthetically in the laboratory. Sugars which possess distinct chemical and physical properties are distinguished by special names, such as sucrose, glucose, fructose, etc. But commercial sugars are named after the particular plants from which they were extracted; thus:—cane sugar, beet sugar, maple sugar, sorghum sugar, and palm sugar; the chief constituent of all these being the single substance—sucrose, or saccharose.

The popular belief that cane and beet sugars are distinct substances, possessing different sweetening powers, may be accounted for in two ways:—(a) The presence of impurities, which may impart colour, odour, and flavour to the crystals; these impurities being different when derived from the cane and the beet. (b) The methods of manufacture, which modify the appearance of the sugar, size of crystals, and form in which it reaches the consumer. But when the two sugars

are refined and crystallised in the same manner, all superficial differences disappear.

The numerous distinct sugars belong to a much larger group of substances, as shown in the following diagram :—

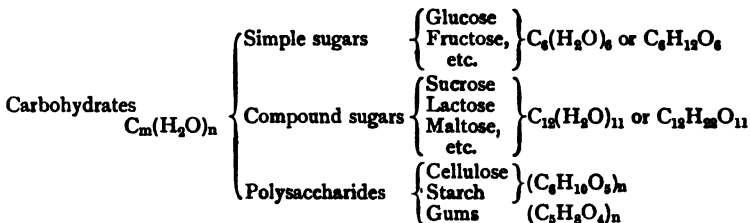

all of which conform to the more general formula $C_m(H_2O)_n$, where m and n stand for various multiples. The polysaccharides are highly complex substances, of unknown molecular weight, this being indicated by multiplying their formulæ by n .

How the complex molecule of sucrose is built up in plants is not yet fully understood, but the following facts are known. Sucrose is formed in the leaf under the influence of sunlight, and in the presence of chlorophyl, the green colouring matter of the leaf. Atmospheric carbon dioxide enters the pores (*stomata*) of the leaf, and is there decomposed; the carbon being retained in the leaf, and the oxygen returned to the atmosphere. The elements—hydrogen and oxygen—enter the plant in the form of water from the soil, but this water previously existed as vapour in the atmosphere. All the constituents of sugar are therefore derived, directly or indirectly, from the atmosphere.

The formation of sucrose from carbon dioxide and water may be represented as follows; but the method of manufacture in the plant is not yet proved.

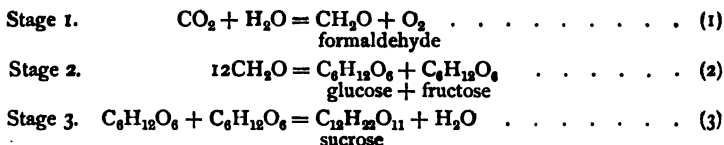

The first product, formaldehyde, has been detected in the leaves of numerous plants, but in such minute quantities that

it appears to be immediately transformed into other substances. Thus, in Stage 2, numerous molecules of formaldehyde condense, forming one molecule of glucose and one of fructose. In Stage 3, the last-mentioned molecules again condense, forming one molecule of sucrose and one of water.

THE PLANT AND ITS ORGANS

The raw material treated in the sugar factory is only a portion of the plant, namely, the stem of the sugar-cane, and the root of the beet, and it is desirable to consider how these are related to the living plant.

Most plants possess three principal organs—root, stem, and leaf. Botanists regard the flower as a modification of the leaf, and the fruit or seed as a further modification of certain parts of the flower (hence, also of the leaf).

(1) *Roots* serve to fix or anchor the plant in the soil, and supply it with water containing mineral matter and nitrogen, dissolved from the soil. Different plants require different quantities of mineral plant-foods, the more important of which are potassium, phosphorus, and calcium, to which must be added nitrogen, derived either from nitrates present in the soil, or from decomposing organic matters. If any of these essential plant-foods are lacking in the soil, the plant cannot thrive.

Roots are of two kinds:—tap-roots and fibrous roots. The tap-root is large and thick, and is adapted for storing materials manufactured by the leaf. Thus, sugar is stored in the tap-root of the beet. A slender root-thread extends downwards from the apex of the tap-root, and numerous branch-threads radiate at right angles to this central axis and spread through the surrounding soil. The majority of plants possess fibrous roots (without tap-root). The root-threads increase in length by growth at the terminal points without appreciable increase in diameter, whereas tap-roots also increase in diameter during growth.

Water and mineral plant-foods enter the small root-threads by diffusing through minute projections (*root-hairs*) which cluster close to the growing tip; new hairs being formed

during the growth of the root-thread. The soil-water, absorbed by the root-hairs, passes upwards through minute channels in the root-thread, and through similar channels in the stem and leaves of the plant.

(2) *The Stem* serves to support the leaves, allowing them to spread apart and thus be freely exposed to the atmosphere and sunlight. The stem also forms a connecting channel through which water and mineral matters ascend from the roots to the leaves, flower, and fruit. The stem of the sugar-cane also serves for storing sugar, and presents a striking contrast to the sugar-beet, which is stemless.

(3) *The Leaf*.—This important organ has many functions. It is the "factory," where sugar, starch, fibre, etc., are manufactured with the aid of energy received from the sun. This energy is stored up in the form of carbon, and is liberated as heat when the dry, solid matter of the plant is burnt. The leaf also represents the breathing-organ; atmospheric gases entering, and waste gases escaping from the leaf, through minute pores (*stomata*), many thousands of which are present in one square inch of leaf-surface. The leaf is also adapted for evaporating the large quantity of water entering at the roots; thus assisting the upward flow of soil-water to the leaf, where the water evaporates, leaving the mineral matters which the plant can utilise. A plant, six feet in height, may evaporate a quart of water per day. The leaf is therefore the centre of activity; soil-water ascending from the roots, and manufactured products (sap) descending from the leaf to the stem and roots.

(4) *The Seed* is the reproductive organ, and only appears towards the close of the plant's life. Fertilisation of the seed results from the union of two elements—the pollen-grains and the egg-cell. The pollen is contained in small vessels (*stamens*), supported on stalks within the flower. The egg-cell is enclosed in the *ovary*, at the base of the flower. Projecting from the ovary are two or more delicate stalks (the *styles*) having feathery heads (the *stigmas*). The combination of ovary, style, and stigma is called the *pistil* of the flower. The pollen-grains, when in contact with the stigma, develop projecting threads which pass down the style and

thus reach the *ovary* and the contained egg-cell. The fusion of these two elements produces the fertile seed.

In many plants, each flower contains stamens and pistils, side by side, and are termed "perfect flowers." The pollen has then merely to fall from the stamens to the adjacent stigmas in order to fertilise the egg-cell; this being termed "self-fertilisation." More generally, the stamens and pistils ripen at different times; in which case, the ripe stigma must receive pollen from other flowers, either on the same plant, or on distant plants. This is termed "cross-fertilisation," and the pollen grains may be transported by the wind, or by insects. Plants which depend on wind-fertilisation produce an immense quantity of pollen, since much of this is lost. Another method of ensuring cross-fertilisation is found in certain plants, where the stamens and pistils are in separate flowers, or even on separate plants.

The fertilised seed contains a complete plant in embryo, also a supply of plant-foods to enable the seed to germinate in contact with the soil, until it has developed roots, and can provide for itself. The seed generally reproduces the type of the parent or seed-bearing plant, but with slight variations, and this natural variability can be utilised in breeding new or improved varieties of plants, as will be explained in the following chapters.

INTERNAL STRUCTURE OF PLANTS

When sections of plants are examined with the microscope, they are seen to be constructed of minute vessels, or cells, which represent the structural units. These cells multiply by division, and each consists of three parts:—(1) An external membrane (*cell-wall*) of cellulose, forming a closed vessel. (2) An enclosed colourless, granular fluid (*protoplasm*), of complex composition, and representing the living-matter of the plant. (3) A granular body (the *nucleus*), embedded in the protoplasm, and which plays an important part in cell-division.

Similar cells, united together, constitute plant-tissue; the properties of which depend on the form of the component cells, and the nature of the cell-walls. Thus, thin-walled cells

constitute the *parenchyma-tissue*, found in the soft portions of the plant, and in which are stored the materials manufactured in the leaf. Thus, sugar is stored in the *parenchyma-tissue*, or pith, of the sugar-cane stem, and in the same tissue of the beet-root.

A modification of the *parenchyma-tissue* gives rise to another type—the *epidermis*, which covers the exterior of the stem and leaves. Thick-walled cells constitute the harder portions of the plant, forming *fibro-vascular-tissue*, which includes two varieties—*wood* and *bast*. The former encloses channels through which soil-water is conducted through the root-threads, and upwards through the stem and leaves. The *bast-tissue* encloses smaller channels through which the sap or juice, manufactured in the leaf, passes downwards to the stem and roots.

Roots are mainly composed of *parenchyma-tissue*, surrounding a central core of *woody-tissue*. Close to the growing tip of each root-thread, the exterior cells are elongated, forming the root-hairs previously mentioned. Stems differ from roots in having the *vascular-tissue* on the outside, surrounding and enclosing the *parenchyma-tissue*.

The leaf has a framework of *woody-tissue* (midrib and veins), embedded in soft tissue (*leaf-parenchyma*), and the whole is covered by the *epidermis*. When a cross-section through a leaf is examined with the microscope, the space lying between the two parallel surfaces (back and front of the leaf) appears of considerable depth or thickness, and composed of many layers of cells, of different sizes and forms. The upper surface of leaf (upper edge of section) consists of flattened, colourless, and transparent cells forming the *epidermis*. Below these, are the coloured cells containing chlorophyl grains. Near the lower surface of leaf (lower edge of section) are numerous air-cavities between the cells, each communicating with the atmosphere by means of the breathing-pores (*stomata*), previously referred to. These air-cavities may be called the lungs of the plant, and the *stomata* may be described as mouths, since they open and close, according to the requirements of the plant at different periods.

The foregoing study may now be briefly summarised. Plants possess three principal organs:—root, stem, and leaf. Flowers and seed are developed later, and may be regarded as special developments of the leaf, designed to reproduce the plant. The organs of plants are composed of three kinds of tissue:—the epidermis, or skin; the soft or parenchyma-tissue, forming the bulk of the organ; and the harder fibro-vascular-tissue, which imparts strength, and encloses channels through which liquids can circulate through the plant. As different organs perform different functions, they contain different proportions and arrangements of the three tissues. Each tissue is built up of microscopic vessels or cells which multiply by division, thus causing growth of the organ. The cells composing different tissues vary in form, size, and thickness of the enclosing cell-wall.

CHAPTER II

I. THE SUGAR-BEET

OF the numerous plants from which sugar is manufactured, the beet is the most recent, but will be described first because it illustrates the success of scientific method when applied to industrial problems. Attempts to obtain improved varieties of sugar-cane followed much later, and have not proved equally successful.

The white sugar-beet, red garden-beet, and mangel belong to the same botanical family, being descended from the Wild Beet (*Beta maritima*). Some variety of this plant was used as a vegetable by the Greeks and Romans, and, in later times, a white beet (*Beta alba*) was long cultivated in Silesia as a forage crop.

In 1747, a German chemist—Marggraf—discovered that the Silesian beet contained from 5 to 7% of sugar, similar to that extracted from the sugar-cane, and he succeeded in extracting and crystallising small quantities of beet sugar in his laboratory. His discovery remained unnoticed for many years, but his pupil—Achard—subsequently cultivated the roots on his estate in Germany, and built the first beet-sugar factory in 1799. This factory produced 6 tons of sugar per annum, costing 2s. 4d. per pound, or £13 per cwt. ! Achard's success led King Frederick William of Prussia to provide funds for building numerous beet-sugar factories in 1801. Shortly after this, France was cut off from her colonial cane-sugar supply by the British blockade, and Napoleon, recognising the possibilities of the new beet-sugar industry, ordered 70,000 acres of French soil to be planted with beet in 1811; he also founded numerous schools for instruction in the art of sugar-making.

At this early period, the percentage of sugar in the beet

was only about one-half of that in the sugar-cane; and the extracted beet-juice contained so much saline impurity that it was difficult to cause the sugar to crystallise when the juice was concentrated by boiling. Hence, the improvement of the plant engaged the attention of scientific men throughout Europe, and two methods of solving this problem were employed, namely:—(a) modifying the conditions under which the plant is grown, and (b) breeding new varieties.

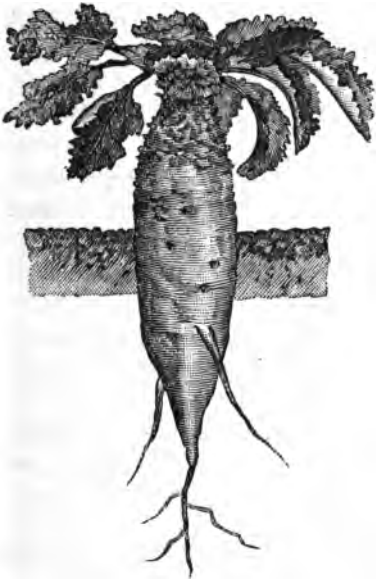

FIG. 1.—FORAGE-BEET

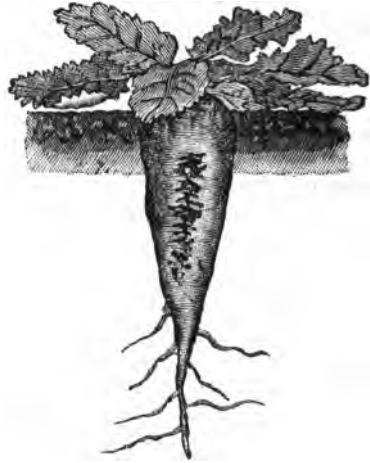

FIG. 2.—SUGAR-BEET

(a) *Modified Conditions during Growth.*—Since the mineral impurities in the juice are derived from the soil and the sugar from the atmosphere, theory suggested that the area of soil feeding each root should be restricted, by growing the plants closer together; yet allowing sufficient space above-ground for the full development of the leaves. Each plant was thus “rationed” in mineral food. This had the effect of diminishing the size of the roots, without affecting the foliage in which the sugar is manufactured. The smaller root therefore contained a higher percentage of sugar and a smaller

percentage of mineral impurities, thus enabling a much larger percentage of the contained sugar to crystallise on concentrating the juice to a thick syrup.

Fig. 1 represents the original forage-beet, and Fig. 2 the modified root, or sugar-beet; the former projecting above the surface of the ground, whereas the latter is completely buried, much reduced in size, and more tapering in form.

The sugar-beet comprises the following organs :—

(1) *The tap-root*, including (a) the "crown," from which the leaves spring; (b) the tapering body in which the sugar is stored; and (c) a thin extension of the tap-root passing vertically downwards for a distance of 2 or more feet (partly shown in Fig. 2).

(2) *Fibrous-roots* spreading horizontally from opposite sides of the tap-root and its vertical extension, and which collect the mineral plant-foods from the soil.

(3) *The leaves*, which spring from the "crown" of the tap-root, and spread laterally above-ground.

(4) *The flower*, which is small, and of a greenish colour, borne on a tall shoot in the second year. The flower finally develops into :—

(5) *The fruit or "seed-ball,"* commonly called the seed, but containing from one to seven embryos (true seeds), and used for propagating the plant.

The tap-root consists of colourless parenchyma-tissue and alternate layers of fibro-vascular-tissue, forming concentric layers which are added to the exterior of the root during its growth. The sugar stored in the parenchyma-tissue, is not uniformly distributed throughout the root; the percentage being highest in the exterior layers, at a point somewhat below the thickest portion of the root; diminishing towards the central vertical axis; and also diminishing upwards (towards the "crown"), and downwards (towards the apex). The exterior skin has a pink colour in certain varieties, but is colourless in others.

The leaves are large, and much crimped at their edges. The central vein, or "midrib," is sometimes purple but more

usually green. When the plant reaches maturity, the leaves become yellow, and fall.

The flower and fruit do not appear until the second year, hence the sugar-beet is a "biennial." As the growth of the seed-bearing shoot consumes a large proportion of the sugar (stored in the root during the first year), the roots must be harvested in the first year, when the percentage of sugar reaches its maximum. Occasionally, the plant flowers and bears seed in the first year, thus behaving as an "annual," and special precautions are taken to prevent further growth of the "shoot" before the root is harvested and sent to the factory. These abnormal plants are termed "shooters." Sometimes, the flower and seed only appear in the third year, and such plants are called "defiers." Variations in the time of seed-bearing are believed to be inherited from early ancestors. For example, "shooters" can be traced back as follows:—

Ancestors { *Beta maritima* (annual) } —Silesian beet—Sugar-beet (usually biennial).
 { *Beta vulgaris* (biennial) }

(b) *Breeding new Varieties.*—This second method of improving the beet was first employed in 1830, by Vilmorin, in France. He was followed by Quedlinburg, in Saxony; and, in 1859, by Rabbethge and Gieseche, at Klein Wanzleben, near Magdeburg, where many new types of sugar-beet have been raised. Other modern producers of beet seed include:—Kuhn & Co., of Naarden, in Holland, and Wohanka & Co., of Prague, in Bohemia. Dr. Harvey W. Wiley supervised the production of the first commercial beet seed grown in America.

In breeding new varieties of plants and animals, advantage is taken of the fact that, although the offspring inherit the general characters of the parent stock, no two individuals are exactly alike. The plant-breeder selects those variations which are useful to him, and endeavours to fix them by collecting seed only from those plants which show the desired variations. Thus, the numerous seedling-beets derived from a single "mother-beet" may differ slightly as regards size of root, sugar percentage, form and colour of leaf, period of

maturing, etc. Any one of these characters may be rendered permanent, and gradually increased, by selecting seed from individual beets, and rejecting seed from unsuitable beets, until the desired type "breeds true."

The modern sugar-beet, containing up to 20% of sugar (and even more), was thus evolved from a root containing only about 7% of sugar. Small samples taken from separate roots were analysed, and those roots containing the highest percentage of sugar were replanted and allowed to bear seed. The new roots, grown from the selected seed, were also analysed; the richest being replanted for seed-production, and all inferior roots rejected. This selection has been continued year after year, from 1830 to the present day, with the result that the sugar-content of the beet has been increased threefold, and is now higher than in the best sugar-cane.

VARIETIES

A few of the numerous varieties are given below.

	<i>French.</i>		<i>German.</i>
Vilmorin's	"Blanche Améliorée."	Klein Wanzleben	"Original," varieties E, N, and Z.
	"Française Riche."		"Braune's Improved" and "Élite."
	"Blanche à collet rose."		"Dippe," varieties Z ₄ W.I., J.L., RR.
	" " " " gris."		"Heine's Improved" and "Élite."
	" " " " vert."		"Mette's Ideal."
	"Élite" A and B.		"Strube," varieties E and Z.
	"Simon Legrand."		"Schreiber," varieties S.O., S.S., SKW.
	"Desprez."		"Breusted's Élite."
"Carlier."	Austrian—"Wohanka," varieties WER and W.Z.R.		
"Legras."			

All modern varieties are descended from two stocks:—"Vilmorin's Blanche Améliorée," and "Klein Wanzleben Original." Like other species of plants, the sugar-beet deteriorates if bred too close, so that new varieties must be frequently interbred with other standard varieties.

Although beets have been produced containing over 20% of sugar, such roots are small in size, and the yield per acre

may be unprofitable to the beet-grower, who sells his roots to the factory. Hence, the interests of the beet-grower have long been opposed to those of the sugar manufacturer, who desires the richest possible roots in order to reduce his working costs. Many of the foregoing varieties have been evolved to satisfy both parties, the richest being cultivated only on land owned by factories. The breeder has also produced varieties adapted to different types of soil, and capable of maturing "early" or "late."

SEED PRODUCTION

The sugar-beet is an artificial plant, having a tendency to revert, or "cast back," to the original or natural type, poor in sugar. This can only be prevented by continued seed-selection, year after year. For each variety of beet there are three qualities of seed, namely:—"super-élite," "élite," and "commercial seed." The first of these is never sold, being the stock-in-trade of the seed-producer, and worth more than £10 per ounce. The "élite seed," or second quality, is also not sold, but is consumed in producing the third quality, or "commercial seed." Five years are required to produce commercial seed, as shown in the diagram on p. 16.

The "steckling beets" are very narrow, due to "close sowing" of the élite seed. This enables a much larger quantity of seed to be produced per acre, and also facilitates "lifting" the roots in the autumn, for siloing during the winter.

In modern practice, the selected mother-beets (grown from the super-élite seed) are individually divided into ten sections before being replanted in the following spring. Each of these sections develops into a complete plant, thereby multiplying the yield of seed tenfold.

The "commercial seed," after being collected, is submitted to the following tests before being sent to market:—

(a) Number of seed-balls per pound weight, thus giving the average weight per seed-ball. It is generally admitted that the heavier seed-ball produces the richest roots.

Handwritten text, likely bleed-through from the reverse side of the page. The text is arranged in approximately 15 columns and is mostly illegible due to the high contrast and blurring of the scan. Some faint characters and words are visible, but they do not form a readable passage.

CHAPTER III

2. THE SUGAR-CANE

THIS plant was probably first cultivated in India, and spread to China and Arabia. The Arabs introduced it into Egypt, Sicily, and south of Spain, in the Middle Ages; and to Madeira in 1420. From Madeira, it spread to the Canary Islands, Brazil, and Hayti, early in the sixteenth century. Later, to Mexico, Cuba, Guadeloupe, Martinique and Bourbon. It was brought from Brazil to Barbados in the year 1641, and thence distributed over the other West Indian islands and adjacent mainland. To-day, the plant is cultivated wherever climate and soil are suitable.

The sugar-cane belongs to the botanical family of grasses (*Graminaceæ*) which includes wheat, oats, corn, maize, etc.; but the sugar-cane towers above them all, sometimes attaining a height of 20 feet. In the tropics, the cane generally flowers and produces seed; but, from remote times, it has been propagated by means of cuttings from the stem or stalk. When planted, the cutting develops roots and sends up numerous shoots forming a cluster or "stool" of canes, shown in the Frontispiece. The stems are all connected below to "root-stock," which is left in the ground when the ripe canes are cut down and sent to the factory.

As the root-stock produces new crops of canes in following years, the plant is a "perennial." The first crop, obtained from the planted cuttings, is known as "plant cane," and the following crops are called "ratoons"; the latter being distinguished as first, second, third, etc. In some countries, ten or even more ratoon crops may be obtained from the root-stock, but owing to decreasing yield per acre, the number of ratoons is usually limited sooner or later in order to maintain a high yield of sugar per acre. The number of ratoon

(b) Percentage of moisture. This should not exceed 14 to 17%.

(c) Germinating test. From 75 to 85% of the seed should germinate within 15 days.

(d) Percentage of foreign matter. This should not exceed 3%.

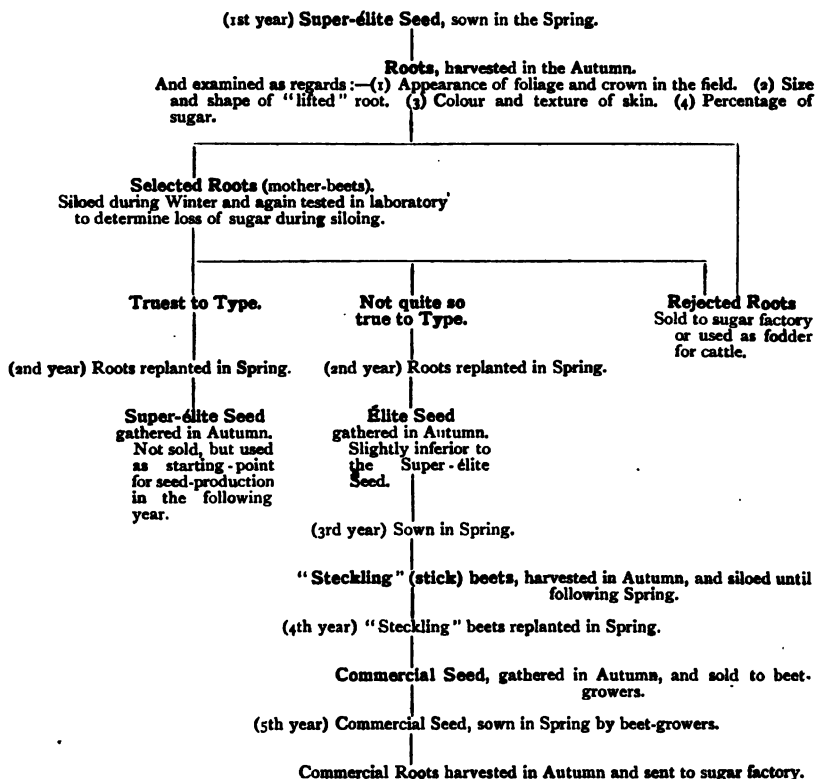

Improved Seed

As each seed-ball contains from one to seven embryos (or true seeds), usually three or four germinate, forming a cluster of young plants at one spot. These have to be separated, or "thinned out," so as to obtain single plants at distances of from 8 to 12 inches, in each row; an operation performed by hand, and, consequently, costly. It is difficult to remove

the surplus plants without disturbing the delicate roots of the one which is to remain, thus retarding its further growth, or even injuring it permanently.

The production of seed-balls containing only single-embryos, was first attempted in 1903, by the U.S. Department of Agriculture, at the suggestion of T. G. Palmer. Although rare, single-seed-balls occur naturally, and were collected, sown, and the resulting beets bore both single and multiple flowers. The latter were cut off, the single flowers covered with paper bags (to protect them from air-borne pollen), cross-fertilised, again covered with the bags, and then left to produce seed. The plants, grown from this seed in 1905, gave the following results. A few plants yielded 50% of single-seed-balls, several yielded over 40%, and many yielded over 30%. In the fourth generation, some plants yielded from 60 to 70% of single-seed-balls, two yielded 80%, and one yielded 85%. For details of these experiments, the reader is referred to Palmer's little treatise on *Sugar Beet Seed*, which is illustrated with numerous photographs.

CULTIVATION

Although this subject lies outside the scope of the present work, a few points may be referred to.

The sugar-beet thrives in temperate climates, but can be cultivated at high altitudes in warm countries, such as Spain, and some parts of America. The soil should not be too light, and must be deeply cultivated in order to ensure the normal development of the tapering roots.

In Europe, the seed is sown in April, and the roots are harvested in September. One kilogram of seed (2·2 pounds) should produce about 70,000 plants in rows 14 inches apart, and plants 10 inches apart in each row.

At harvest-time, the soil is loosened around the roots by running suitable ploughs along the rows, after which the roots can be lifted or "pulled" by hand. Various mechanical beet-harvesters have been invented, some of which are now in use. After "lifting," the crowns and attached leaves are cut off, and the roots sent to the factory. Here, they pass through

mechanical "washers," which remove all adhering soil and stones, and the clean roots pass to the weighing machine. The beet-grower is paid on a basis of this "true" or "net weight," which is very much less than the "gross weight" transported from the field to the factory.

The tonnage of "clean roots" per acre varies considerably in different countries, according to the variety of beet cultivated; it also varies in any one country in different years according to the rainfall. The following figures are averages for ten years (1901-1911):—Austria-Hungary 9·5, Belgium 11·2, Denmark 11·2, France 10·3, Germany 12·0, Holland 10·4, Russia 6·0.

CHAPTER III

2. THE SUGAR-CANE

THIS plant was probably first cultivated in India, and spread to China and Arabia. The Arabs introduced it into Egypt, Sicily, and south of Spain, in the Middle Ages; and to Madeira in 1420. From Madeira, it spread to the Canary Islands, Brazil, and Hayti, early in the sixteenth century. Later, to Mexico, Cuba, Guadeloupe, Martinique and Bourbon. It was brought from Brazil to Barbados in the year 1641, and thence distributed over the other West Indian islands and adjacent mainland. To-day, the plant is cultivated wherever climate and soil are suitable.

The sugar-cane belongs to the botanical family of grasses (*Graminaceæ*) which includes wheat, oats, corn, maize, etc.; but the sugar-cane towers above them all, sometimes attaining a height of 20 feet. In the tropics, the cane generally flowers and produces seed; but, from remote times, it has been propagated by means of cuttings from the stem or stalk. When planted, the cutting develops roots and sends up numerous shoots forming a cluster or "stool" of canes, shown in the Frontispiece. The stems are all connected below to "root-stock," which is left in the ground when the ripe canes are cut down and sent to the factory.

As the root-stock produces new crops of canes in following years, the plant is a "perennial." The first crop, obtained from the planted cuttings, is known as "plant cane," and the following crops are called "ratoons"; the latter being distinguished as first, second, third, etc. In some countries, ten or even more ratoon crops may be obtained from the same root-stock, but, owing to decreasing yield per acre, the fields must be replanted sooner or later in order to maintain a satisfactory yield of sugar per acre. The number of ratoon

crops differs as follows:—four or five in the West Indies, three in Mauritius, and one in Louisiana. But, in Java, fiscal regulations prohibit the cultivation of ratoon canes, and only plant canes are grown.



FIG. 3.—SUGAR-CANE

From Thorpe's *Dictionary of Applied Chemistry*
(Longmans & Co.)

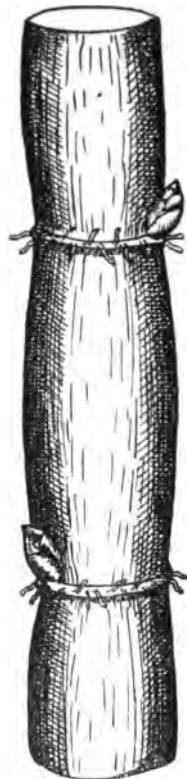

FIG. 4.—CANE-STEM
SHOWING BUDS

The roots are fibrous, and spread to a distance of $1\frac{1}{2}$ to 3 feet from the base of the stem. In sandy soils the root-threads may descend 10 or even 15 feet.

The stem or stalk varies in length, diameter, and colour, and has a hard, external skin, with smooth, glazed surface, the colour varying from pale yellow or green, to deep purple. In many varieties, stripes of one colour appear over another

(see coloured plates in Deerr's *Cane Sugar*). As the coloured rind is exceedingly thin, the bulk of the stem consists of colourless parenchyma-tissue, in which the juice is stored.

The stem is divided transversely by knots, or nodes, varying in number. The smooth portion of the stem, lying between two nodes, is the internode, and, including the two nodes, forms one joint, which varies in length from 4 to 9 inches; and in diameter, from $\frac{1}{2}$ to 2 inches. The nodes mainly consist of fibro-vascular-tissue, and are therefore much harder to crush than the internode, composed of parenchyma-tissue. The stem ripens joint by joint from the bottom upwards; and as each joint ripens, the attached leaf withers and falls, or is removed by hand (stripping the cane). The mature plant has therefore a long bare stem, supporting a tuft of spreading leaves (Fig. 3). When harvested, this leafy "cane top" is cut off, and generally employed as planting material, in the manner described below.

A single leaf springs from every node, on alternate sides of the stem, and consists of two parts:—the true leaf or blade, from 3 to 4 feet in length, and from 2 to 3 inches in width; and the leaf-base, or sheath, encircling the joint from which it springs. In the young plant, the leaves completely envelop the stem, but later, spread apart in graceful curves. On the underside of the leaf, a strong central vein or "midrib" extends centrally to the extreme tip, with numerous parallel veins, characteristic of the family of grasses.

At each node, opposite to the attached leaf, is the "eye," or bud, shown in Fig. 4. A bud is usually a growing point of the stem, developing into a branch-stem; but the sugar-cane bud only sprouts when buried in the soil, and then reproduces the complete plant. As every node bears a bud, any joint of the stem serves as planting material; but the soft, uppermost joints, or "cane tops," give the best results. But when planting must be carried out before the present crop is mature, a certain quantity of cane is grown to provide planting material; the entire stems being cut up for this purpose. The planter calls this "seed-cane" in order to distinguish it from the main crop sent to the factory. "Planting-cane" would be a more appropriate name.

The short projecting fibres, encircling the stem at each node (see Fig. 4), are the "dormant," or "sleeping-roots," capable of developing when the joint is planted, and providing a root-system to the young plant sprouting from the adjacent "eye." As each new stem, or shoot, bears similar "eyes," those which lie below-ground also sprout, producing secondary shoots; consequently a large number of new canes develop from a single cutting.

Most varieties of cane flower on reaching maturity. The flower is of microscopic dimensions, but collectively they form a feathery tuft (the "arrow") borne on a hollow stalk 2 or 3 feet in height, which grows erect from the topmost joint of the cane. The stem of the "arrow" is repeatedly branched, and the slender branches bear minute "spikelets," or flowers, arranged in pairs, at distances of about one-eighth of an inch apart. Each spikelet comprises the following organs: two exterior protecting scales (*glumes*), of a green or purple colour; and an interior colourless scale (the *palea*). These surround the more delicate structures, namely, the ovary (containing the *ovule*, or egg-cell), having two feathery stigmas, and three anthers containing the pollen grains. When mature, the anther bursts open, scattering the pollen, which is carried by the wind to distant flowers where it adheres to the sticky surface of the stigmas. Here it germinates, and ultimately reaches the ovule, where the male and female cells unite. The fertilised ovule represents the fruit, or grain of the plant, but is commonly termed the seed.

VARIETIES OF SUGAR-CANE

These may be grouped under two heads:—Natural Varieties, and Seedling or Hybrid Varieties

(a) *Natural Varieties* have been slowly evolved under conditions which render their classification very difficult. A variety, natural to a particular country, has been frequently transported to other countries, receiving a new name in each, and being modified in character by new climatic conditions. In a bulletin entitled, *Varieties of Cane, with*

special reference to Nomenclature, Deerr and Eckhart have collected various names given to certain varieties of cane. For example, the Cheribon, or Batavian canes are divided into three groups, according to the colour of the stem, namely, light, dark, and striped. The light-coloured variety is known under five different names in different countries; the dark variety is also known under five different names; and the striped variety under six different names. The nomenclature adopted by Deerr and Eckhart will be found in Deerr's *Cane Sugar*, Chapter IV. A scientific classification, based on botanical differences, is urgently needed, but has yet to be made.

(b) *Seedling Varieties*.—The fertility of the cane seed was known in 1858, and canes were grown from seed in Barbados, about the year 1860. For many subsequent years it was believed that the seed was infertile, owing to the practice of propagating the plant from cuttings. The modern seedling-cane is due to the rediscovery of the fertility of the seed by Harrison and Bovell, in 1889.

The seedling-cane shows great variability from the parent, or seed-producer; also from other seedlings derived from the same parent. This variability suggested a means of obtaining new varieties direct from seed, some of which might prove superior to the staple, or natural varieties.

An immense number of seedling-caness have since been raised in different countries, the majority of which had to be rejected as worthless in the first year. Those which showed any promise were kept under observation for several generations, and the extracted juice analysed. A large number were again rejected, and only the superior seedlings continued under observation on the experimental plots. The best of these were finally tested on the estates under normal field-conditions, being propagated from cuttings in the usual manner. Such practical tests were first carried out on estates in the countries where the seedlings were raised, and later, in other countries. It was found that certain varieties are particularly adapted to certain climatic conditions; for example, two Demerara seedling varieties, D. 74 and D. 95, which proved of little value in

their native land, gave excellent results in Louisiana, because capable of maturing early. Many gave good results under estate-conditions, but deteriorated after continued cultivation for several years; hence, new seedling-canes must be raised annually in order to replace those which deteriorate.

Most of these varieties were raised from seed taken from a selected cane, or mother-plant, but fertilised by pollen of unknown origin. A successful seedling is therefore discovered by chance, and cannot be reproduced at a future date, if required, since only one parent is known. In order to produce pedigree-canes, it was essential to select both parents, and to transfer the pollen from one to the other. The first method employed was to enclose the arrows of each parent-cane in cloth bags before they reached maturity, thus preventing the entrance of wind-borne pollen. When the arrows ripened, the contents of the bags of one variety were shaken into the bags of the other variety through a small opening at top, which was then closed. As this did not sufficiently guard against self-pollination, it had to be abandoned.

A great advance was made in 1894, when Wakker discovered that the Cheribon cane bears a normal pistil and egg-cell (or ovule) but infertile pollen, and is therefore incapable of self-pollination. This discovery led to the production of numerous hybrid canes in Java by growing the Cheribon cane in alternate rows with other good varieties which produce fertile pollen.

The examination of seedling-canes raised in Barbados has proved that they may be grouped into three classes, namely :— (a) containing a large proportion of fertile pollen; (b) a very small proportion; and (c) a medium proportion. Hence, if two arrows, one of class (a) and the other of class (b), be introduced into a closed bag and allowed to ripen side by side, out of contact with air-borne pollen, the fertilised seeds will almost certainly be true hybrids of the parent-canes, and the chances of self-fertilisation are reduced to a minimum. The two parent-canes need not be growing side by side, because the arrow of the cane which is to supply the pollen can be cut off with its stalk, the latter

inserted in a bamboo-joint containing water, and attached to the arrow of the second cane which is to supply the seed; both arrows being then enclosed in a bag in order to exclude air-borne pollen. The bag is suspended from a cross-piece attached to the top of a long bamboo fixed vertically in the ground.

Under these conditions, the mother-arrow may yield over 1000 seedling hybrids, and, should any of these prove suitable, a fresh stock of the hybrid can be obtained at any future date by repeating the cross-pollination with the original parent-canes. The hybrid varieties thus obtained have not, however, proved superior to those obtained by the earlier method of chance-pollination; but the results are encouraging, and workers are confident of ultimate success. The method is now being employed in the West Indies, Java, Hawaii, Cuba, India, and Queensland.

Another method, first suggested in 1900, and successfully carried out in 1904, consists in removing the stamens (containing the pollen) from a few flowers of one plant, and introducing pollen from a second plant to the stigma of the emasculated flowers. The operations must be performed with the aid of a microscope, and the operator is perched on a platform about 10 feet above the ground, so that the flowers can be placed on the stage of the microscope and the minute stamens removed before they reach maturity. The arrow is then enclosed in a muslin bag until the stigma ripens, when the flower is again brought under the microscope and pollinated by hand with pollen from another selected variety of cane. In spite of the great difficulty attending this method, five hybrid canes were thus produced in Barbados, four in Queensland, and about 600 in Cuba.

In the foregoing methods, a single cane-plant can be used either as the male or the female parent, since the flowers normally contain both sexual elements. Consequently, cross-pollination between two varieties of cane can be effected in two directions:—the pollen-parent in one cross being used as the seed-parent in the second cross.

The aim of the cane-breeder is to produce varieties of higher economic value than the well-known natural varieties.

Richness in sugar is by no means the most important consideration, because the yield of sugar per acre depends upon numerous factors, namely:—(1) Resistance of the cane to disease. (2) Resistance to drought and excessive rainfall. (3) Tonnage of canes per acre. (4) Richness and purity of juice. (5) Period required for maturing. (6) Milling quality of cane, due to the nature of its fibre. (7) Suitability of crushed cane (bagasse) as fuel. It being impossible to consider all these characters when selecting two parent-canes to be crossed, the breeder may select one parent-cane for its ability to resist disease, and the other for its high tonnage per acre, in the hope of combining these two characters in the resulting hybrid. Other characters may be combined in a similar manner.

Seedling varieties are distinguished by means of the initial letter of the name of the country in which each variety was raised, followed by a number. Thus D. 95 is a well-known Demerara variety; and B. 109 is one of many varieties raised in Barbados.

SUGAR-CANE AND SUGAR-BEET COMPARED

The percentage of sucrose in the two plants varies very considerably in different countries, owing to climatic conditions, mode of cultivation, etc. A direct comparison is only possible by selecting those countries where sugar-production has attained the highest degree of efficiency; namely, Germany for the beet, and the Hawaiian Islands for the cane. The following figures represent general averages.

	<i>Beet</i> (Germany)	<i>Cane</i> (Hawaiian Islands)	
		<i>A</i>	<i>B</i>
Weight of crop per acre (tons)	12·0	44·0	66·0
Sucrose % in plant	16 to 17	14	16
Commercial sugar obtained per acre (tons) .	1·7 to 2·0	4·0	6·0
" " " % on plant	15 to 16·5	12·5	14·5

Column A (under "Cane") refers to non-irrigated estates, and column B to irrigated estates. The tons of canes per acre in Hawaiian Islands far exceeds the weight per acre in other countries, the next highest tonnage being Java, with 27 to 42. The cane yields twice or even three times as much sugar per acre as the beet. On the other hand, the cane contains less sugar than the beet, and the extraction of sugar from the cane is inferior to that from the beet.

CHAPTER IV

OTHER SUGAR-PRODUCING PLANTS

BEFORE concluding this section, reference may be made to a few other plants which have been, or are still employed in the production of sugar.

3. SORGHUM CANE, OR SUGAR-GRASS (*Sorghum saccharatum*)

This closely resembles the sugar-cane but is not so tall and belongs to the same botanical family. It has a jointed stem; long, ribbon-shaped leaves, one springing from each node; and bears a feathery tuft of minute flowers, projecting vertically above the stem. It differs from the sugar-cane in producing separate male and female flowers, and much larger seed. When mature, the seed-top or "panicle" represents from 15% to 25% of the total weight of the plant, and therefore droops over. The seed-tops are reserved for planting, or for fodder. Being propagated from seed, the plant is capable of being improved in the same manner as the sugar-beet.

It matures within 3 months in the tropics, and an average crop yields from 8 to 10 tons of stems per acre, sometimes rising to 15 tons. The stems are crushed in mills, and the yield of crystallised sugar is about 5.5%, or only about half a ton of sugar per acre, as compared with 4 tons per acre from the sugar-cane in Hawaii and Java.

4. MAIZE, OR INDIAN CORN (*Zea mays*).

This plant belongs to the same botanical family as the sugar-cane and sorghum, and grows to a height of 11 feet. It resembles sorghum in producing separate male and female flowers, but the seed is very much larger, and is arranged

in parallel rows around a central core or stem (corn-cob). Being rich in starch, fats, and gluten, the corn-cob is a valuable fodder; the unripe cob is often used as a vegetable, and has a pleasant flavour.

Maize is propagated from seed, and grows very rapidly. As the percentage of sucrose in the stem decreases as soon as maturity is reached, the crop must be harvested within 21 days, at the period of maximum sugar-content.

The percentage of sugar on weight of dry matter in the stem averages 8.6, but varies in different varieties as follows:—“Transylvanian” = 16.69%; “Early Variety” = 14.3%; “American White” = 13.32; and “Roumanian” = 10.56%. If the cob is cut off as soon as it is formed, more sugar is stored in the stem, the above average increasing from 8.6 to about 11%. It is therefore probable that the sugar stored in the stem is ultimately converted into starch in the seed.

5. THE SUGAR MAPLE (*Acer saccharum*)

The Sugar Maple, also called the “Rock” or “Hard Maple,” is the chief source of Maple Sugar, but is supplemented by the “Black Maple” (*Acer saccharum nigrum*), the “Red Maple” (*Acer rubrum*), and the White or “Silver Maple” (*Acer saccharinum*), all of which are tall trees with thick branching trunks.

Maple sugar was probably first manufactured in India, but has since been produced in the eastern provinces of Canada, and in the north-east of the United States. Apart from the sugar contained in the sap, the tree is valued for its hard wood, which is suitable for many purposes. The leaves resemble those of the English Maple (*Acer campestre*), being deeply lobed on opposite sides, but each lobe terminates in a point. The tree bears clusters of small greenish flowers, which are fertilised by wind-borne pollen.

The young seedlings are planted in plantations, or “maple bushes,” containing from 400 to 5000 trees. When mature they yield sap for many successive years, but only during 3 weeks in each year. At the beginning of this period, the trees are tapped by boring two or three holes, 1 or 2

inches deep, into the trunk, at a point a few feet above the ground; the holes being $\frac{3}{8}$ to $\frac{1}{2}$ inch in diameter. Into each hole is driven one end of a metal tube, from the projecting end of which hangs a vessel of tinned iron. The sap is collected from these vessels twice daily, and at once conveyed to the sugar factory, as fermentation soon follows. The extraction of maple sap from the living tree is repeated year after year, by boring new holes. One tree yields from 12 to 24 gallons of sap each season, and 1 pound of maple sugar is obtained from $4\frac{1}{2}$ to 6 gallons of sap.

6. THE SUGAR PALMS

(a) *Wild Date Palm* (*Phoenix sylvestris*) is extensively cultivated in India. It averages 60 feet in height, and its feather-shaped leaves are from 8 to 12 feet in length. It bears fruit for about 70 years, producing up to 600 pounds of dates annually. The sap is drawn or "tapped" when the trees are 7 years old, and during the following 20 or 25 years, and the fresh sap contains from 10 to 12 grams of sucrose per 100 c.c. During each year, the trees are "tapped" for 100 days, and a single tree will yield 170 kilos. (374 pounds) of sap, from which 17 kilos. (37.5 pounds) of sugar are made.

(b) *Coco-nut Palm* (*Cocos nucifera*) attains a height of from 90 to 100 feet, and has feather-shaped leaves, 15 feet in length. The tree flowers and bears fruit when 5 years old, and continues to bear for 100 years or more, producing from 150 to 300 nuts annually. The flowers are first white, then cream-coloured, and finally golden. The nuts grow in clusters of from 5 to 15, and there may be 20 clusters on one tree, in different stages of maturity; each nut ripening in 12 months. When planted, the nuts sprout, and the young palms are replanted 20 to 30 feet apart. Geerligs states that an average tree yields 0.65 litres (1.1 pints) of sap in 24 hours, but selected trees may yield as much as 1.40 litres (2.5 pints). Young trees yield 300 litres (66 gallons) per year, and at the age of 40 years, the yield increases to 400 litres (88 gallons) per year. The fresh sap contains about 16.5% of sucrose, and the purity is 94.0.

(c) *Sugar Palm of Ceylon (Caryota urens)* is also known as the "Jaggery Palm" in Madras. It has a perfectly straight stem, about 60 feet in height.

(d) *Palmyra Palm (Borassus flabelliformis)* is also known as the "Fan" or "Toddy" Palm, and is cultivated in Madras and Burma. It has a very erect stem, 70 to 80 feet in height, and bears fruit as large as an ostrich egg, growing in thick clusters. The tree lives for from 200 to 300 years, and is valued, not only for its sugar, but for its fruit and wood. The manufacture of sugar from this palm in India dates back to antiquity. The sap contains from 14 to 16 grams of sucrose per 100 c.c., and 3 quarts of sap yield 1 pound of crude sugar or "jaggery."

(e) *Aren Palm (Arenga saccharifera)* is cultivated as a sugar-producer in the Dutch East Indies. The sap is collected in hollow bamboo-tubes (3 joints in length), and Geerligs states that one flower-stalk yields two bamboo-tubes of sap daily, during one month. As a full-grown tree bears 3 flower-stalks per annum, the yield of sap is 180 bamboo-tubes per year. The tree continues to yield sap for 3 years.

(f) *Nipa Palm (Nipa fruticans)* differs from the foregoing palms in its stunted growth, so that the sap can be tapped without climbing. It bears fruit 4 years after planting, and the sap is tapped in the fifth and following years, during 3 months of each year. One tree yields about 0.6 litres (1 pint) of sap per day; but, as the rate of flow decreases, the yield per annum is about 112 litres (24½ gallons). The fresh sap contains about 17% sucrose, and its purity is 94.0. Owing to rapid inversion of sucrose during tapping and transport, the sap has not yet been used for manufacture of sugar, but for production of alcohol.

Methods of Tapping the Sap

The sap of the wild date palm is "tapped" in the manner previously described for the maple tree, but at the top of the tall stem, about 60 feet above the ground. The native "toddy drawer" swarms up the tree almost as rapidly as a monkey, by means of a belt (made from the leaf of the palm), loosely encircling the tree and also his legs. By

pressing his feet against the palm-stem, the belt is drawn taut, and can bear his weight, leaving his hands free to grip the stem above his head. These movements of hands and feet are rapidly repeated until he arrives at the top, and sits astride of the base of one of the lowermost leaves in order to carry out the following operations. The lowest leaf is stripped off leaving a bare space, about one foot in length. Here, he cuts a shallow triangular hole, one angle pointing downwards. Ten days later, the hole is deepened, and a hollow bamboo-tube is fixed below it, to lead the escaping sap into an earthen vessel. In the course of a week, about 15 litres ($3\frac{1}{2}$ gallons) of sap will be collected. The hole is deepened every seventh day, and ultimately extends nearly half-way through the tree. The tapping continues for about 100 days, during which period a single tree will yield 170 kilos. (374 pounds) of sap, from which 17 kilos. (37.4 pounds) of sugar are made. In Bengal, the yield is only about 22 pounds of sugar crystals, per tree, per year. Assuming 350 trees per acre, this would yield 3.6 long tons of raw sugar per acre.

A very different method of tapping is adopted for the other palms, referred to above; the sap being drawn from the flower-stalk in the following manner. About a month before tapping begins, the flower-stalk is fastened to the stem of the palm and gently beaten with a wooden mallet; first daily, then every second day, and later, every third day; the stalk being gently swung to and fro after each beating. This treatment promotes the flow of the sap. A small cut is then made in the stalk, and if the sap does not escape freely, the beating and swinging are continued. As soon as the sap flows freely, the stalk is cut through (thus removing the flowers) and the cut extremity is inserted in a hollow piece of bamboo, 3 joints in length, and closed at its lower extremity. This bamboo collects the sap, and is replaced by a fresh one every 12 hours.

PART II

EXTRACTION OF JUICE FROM THE CANE

- CHAPTER 5. PRINCIPLES OF THE MILLING PROCESS
- „ 6. MILLING MACHINERY, AND MODE OF OPERATING
- „ 7. CAPACITY AND EFFICIENCY OF MILLS
- „ 8. OTHER METHODS OF JUICE-EXTRACTION



CHAPTER V

I. PRINCIPLES OF THE MILLING PROCESS

THE cane-mill differs from most other mills in the application of pressure without grinding action, and the simplest form now used is a combination of three horizontal rollers, so grouped that the lines joining their centres form a triangle (Fig. 5, A, and Fig. 6). The top-roller applies two simultaneous pressures, by co-acting with each of the lower

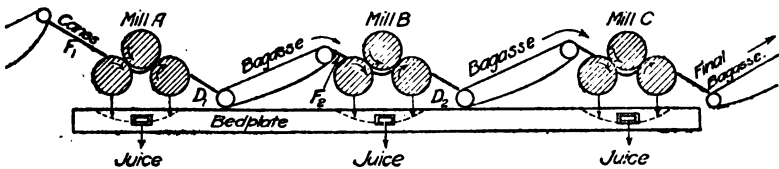

FIG. 5.—DIAGRAM OF NINE-ROLLER MILL

rollers in the directions corresponding to the sides of the triangle. The arrangement is therefore equivalent to the double-crushing action of two independent pairs of rollers, but is more compact. This three-roller combination dates from 1794, and may still be seen in numerous small factories.

The modern multiple mill is a combination of three, four, or five of these single mills, arranged one behind the other, and dates from 1843. Thus, three units form the nine-roller combination in Fig. 5. The canes enter mill A by sliding down the inclined feed-plate F_1 , the crushed cane leaving by the discharge-plate D_1 . A mechanical transporter then elevates it to the feed-plate F_2 of mill B, and so on, as indicated by the dotted arrows. The pressure applied to the cane ruptures the minute cells in which the juice is stored, and the juice flows over the surfaces of the lower rollers, and falls into a receiver below. As the bulk of the juice escapes

under moderate pressure, the main problem is to extract the final portions of juice which are retained by the fibre, as moisture is retained by a sponge.

In the single, or three-roller mill, extraction is effected by pressure only; hence the term "dry-crushing." In the multiple mill, pressure is combined with a washing or diluting process between two or more of the mill-units (A, B, and C in Fig. 5); hence the terms—"wet-crushing," or "saturation," or "maceration."

In dry-crushing, the quantity of juice retained by the crushed fibre depends solely on the reduction in volume of the fibre at the moment of maximum compression. This may be calculated as follows.

Let A = Area of aperture between co-acting rollers = length \times distance apart.

Let B = Volume of compressed fibre, per revolution of rollers = $A \times$ circumference of rollers.

Then, $B \times$ revolutions per minute = compressed volume of x tons fibre entering mill per minute.

As the cane usually contains about 12% fibre, the crushed fibre represents a very small fraction of the original volume of cane. The apertures between co-acting rollers are therefore small, and decrease from unit to unit of a multiple mill.

If a nine-roller combination (Fig. 5) were employed for dry-crushing, the first unit (A) would extract the bulk of the juice, and the quantity extracted by the last unit (C) would be too small to justify the initial cost of this unit.

The principle of wet-crushing may be demonstrated as follows. Crushed cane-fibre, leaving mill A, enters a second and similar mill B, which applies exactly the same pressure, and, consequently, extracts no additional juice by dry-crushing. Water is now sprayed upon the fibre leaving mill A, and the fibre, by absorbing this water, increases in volume from V_1 to V_2 . As the absorbed water mixes with, and dilutes the juice contained in the fibre, the increase in volume is the effect of such dilution. On now entering mill B, the saturated fibre is compressed to its former volume V_1 , due to the extraction of $V_2 - V_1$ volumes of diluted juice.

The result may be stated as follows. Mill A extracts rich juice by pressure only. The water added between A and B *displaces* an equal volume of liquid (juice *plus* water) when the saturated fibre is re-crushed to its former volume, thus enabling mill B to supplement the extraction performed by mill A *without any increase in pressure*. This example serves to illustrate the effect of displacement alone. In practice, mill B would be adjusted to exert a higher pressure than mill A, thus combining the advantages of displacement + increased pressure.

Each unit of a multiple mill must "pay its way" by extracting sufficient juice, and the number employed is mainly determined by the quantity of water that can be profitably added between the separate units. The addition of water depends on the quantity and market-value of the additional units of sugar extracted by the final unit of added water. For example, whether it is profitable to apply 16 tons of water per 100 tons of canes, depends on whether the final or sixteenth ton of water extracts sufficient sugar to cover all subsequent expenses of converting this portion of sugar into crystals. The following considerations must therefore be taken into account:—

(1) A larger number of water-units can be profitably applied when treating canes rich in sugar, than when treating poor canes.

(2) As the added water is required to saturate the crushed fibre, the number of water-units added per 100 of cane should be proportional to the percentage of fibre in the cane.

(3) The efficiency of the added water depends very largely on the method of applying it, and is therefore an important factor in determining the economic limit of saturation.

The first and second factors are clearly due to the variable composition of the canes treated, and will be referred to again. The third factor must now be considered.

In the case of a nine-roller mill (Fig. 5), a given quantity of water can be applied in three different ways, as follows:—

(a) *Single Saturation*.—The whole of the water is applied between B and C; in which case, A and B operate as dry-crushing units, and C extracts the diluted juice.

(b) *Double Saturation*.—Half the water is applied between A and B, and the remaining half between B and C. In this case, A is the dry-crusher, B extracts once-diluted juice, and C extracts twice-diluted juice.

(c) *Compound Saturation*.—The whole of the water is applied between B and C (as in the case (a)), and the diluted juice extracted by C is applied between A and B. In this case, A is again the dry-crusher, B extracts twice-diluted juice, and the whole of the dilute juice extracted by C is returned between A and B, and extracted by B.

These three methods may be compared by applying them to the same triple-crushing mill, treating canes containing 10% fibre, and adding water in the proportion of 20% on weight of canes (equal to twice the weight of *dry fibre* in canes). We will assume that:—

	<i>Liquid.</i>	<i>Dry Fibre.</i>
Pressure in mill A produces first-bagasse containing =	65	35
" " B " second-bagasse containing =	60	40
" " C " third- " " =	55	45

Also, that the added water mixes completely with the juice contained in the bagasse, to which it is added.

(a) *Single Saturation*.—Eighty parts of water are added between B and C to 40 parts of fibre in second-bagasse; where they mix with 60 parts of true (undiluted) juice, forming 140 parts diluted juice, containing $\frac{60 \times 100}{140} = 42.9\%$ true juice.

After re-crushing in mill C, the third-bagasse contains 55 parts of liquid. Hence, loss in mill C = $\frac{55 \times 42.9}{100} = 23.6$ parts true juice on 45 parts of fibre.

$$\text{As canes contain } 10\% \text{ fibre, loss \% on cane} = \frac{23.6 \times 10}{45} = 5.24\%$$

$$\text{As canes contain } 100 - 10 = 90\% \text{ juice, loss} = \frac{5.24 \times 100}{90} = 5.82\% \text{ of total juice in cane.}$$

(b) *Double Saturation*.—Forty parts of water are added between A and B to 35 parts of fibre in first-bagasse; where,

they mix with 65 parts of true juice, forming 105 parts of diluted juice, which contains $\frac{65 \times 100}{105} = 61.9\%$ of true juice.

After re-crushing in mill B, 40 parts of water are added between B and C to 40 parts of fibre in second-bagasse; where they mix with 60 parts of previously diluted juice (containing 61.9% true juice), forming 100 parts of twice-diluted juice, which contains $\frac{60 \times 61.9}{100} = 37.1\%$ true juice.

After re-crushing in mill C, the third-bagasse contains 55 parts of liquid. Hence, loss in mill C = $\frac{55 \times 37.1}{100} = 20.4$ parts true juice on 45 parts of fibre.

As canes contain 10% fibre, loss % on cane = $\frac{20.4 \times 10}{45} = 4.5\%$.

As canes contain $100 - 10 = 90\%$ juice, loss = $\frac{4.5 \times 100}{90} = 5.0\%$ of total juice in canes.

The loss of juice is therefore 5.82 in method (a) and 5.0 in method (b). In practice, the added water does not completely mix with the bagasse-juice (as has been here assumed), and the degree of admixture decreases with the quantity of water (or diluted juice) applied at one stage. Hence, the advantage of method (b) over method (a) would be greater than the foregoing calculations indicate.

(c) *Compound Saturation.*—In this more complicated case the calculations may be divided into the following steps:—

Step 1 is identical with single saturation (case (a) above).

Mill C extracts $140 - 55 = 85$ parts dilute juice, containing $\frac{85 \times 42.9}{100} = 36.5$ parts of true juice, and $85 - 36.5 = 48.5$ parts of water.

Step 2. These 85 parts of diluted juice are added to first-bagasse between A and B, and mix with 65 parts of true juice, forming 150 parts diluted juice, containing $65 + 36.5 = 101.5$ parts of true juice, or $\frac{101.5 \times 100}{150} = 67.7\%$ true juice.

Step 3. After re-crushing in mill B, the second-bagasse contains 60 parts of liquid, containing $\frac{60 \times 67.7}{100} = 40.6$ parts of true juice.

Step 4. Eighty parts of water are added between B and C, and mix with 60 parts of previously diluted juice, forming 140 parts of twice-diluted juice, which contain $\frac{40.6 \times 100}{140} = 29.0\%$ true juice.

Step 5. After re-crushing in mill C, the third-bagasse contains 55 parts of liquid. Hence, loss in mill C = $\frac{55 \times 29}{100} = 16$ parts true juice per 45 parts of fibre.

As canes contain 10% fibre, loss % on canes = $\frac{16 \times 10}{45} = 3.55\%$.

As canes contain $100 - 10 = 90\%$ juice, loss = $\frac{3.55 \times 100}{90} = 3.95\%$ of total juice in canes,

Steps 1 to 5 represent the results obtained soon after the mill begins to operate, and the full effect of compound saturation is only obtained after the diluted juice extracted by mill C has been repeatedly returned to the bagasse between mills A and B. The loss of true juice in bagasse from mill C then gradually falls from 3.95 to about 3.0%; the latter figure remaining constant so long as the mill continues in action. Compound saturation shows a considerable advantage over single and double saturation, because the same total quantity of added water is used twice over.

The foregoing calculations are only introduced here to illustrate general principles. In practice, the percentage of sugar in the final bagasse is the direct guide in milling, and the density or percentage of sugar in the juice extracted by the last mill is a general guide as to the quantity of water to add, and the best method of applying it. The economic limit of saturation is determined in each factory by the existing facilities for evaporation, the cost of other fuel to supplement the

bagasse, the market-value of the sugar produced, cost of labour, etc.

Saturation presents certain practical difficulties which may here be referred to. It is useless to spray water upon the bagasse unless the fibre is in a suitable condition to absorb it. Large, flattened pieces of cane absorb no water, owing to the protecting layer of hard rind. In the example of triple-crushing considered above, the application of water (or of dilute juice) between the units A and B would, on this account, be less effective than between B and C. The best results are obtained by applying water at the latest possible stage. For example, in a quadruple mill, the first two units may be employed for dry-crushing, thus thoroughly preparing the fibre for the saturation. Water would be applied between C and D (last mill); and the dilute juice extracted by D would, in turn, be applied between B and C; thus combining dry double-crushing with compound saturation.

Attention should also be given to the following points:—

(a) The added water does not dissolve sugar from the fibre; the sugar being already dissolved in the juice present in the fibre. The water is therefore merely a diluting agent.

(b) Consequently, hot water has no advantage over cold, and should be avoided if possible, because it extracts certain constituents of the fibre which are insoluble in cold water. Further, it is desirable to know the exact weight of added water, and this is impossible in the case of hot water, owing to evaporation during milling.

(c) The added water should be clean in order to avoid contamination of the juice with ferments and non-sugars. Hot water (from condensed steam) ensures absence of bacteria, and is sometimes the only available supply of clean water.

(d) In compound saturation (method (c)), the diluted juice employed for saturation must be of considerably lower density than the bagasse-juice to which it is added. The greater the difference in density, the more effective will be the saturation.

Although saturation and multiple-crushing are essential to high extraction of sugar, it must be admitted that objectionable impurities may be also extracted. The best grade of

Demerara "yellow crystals" is manufactured from juice extracted by dry-crushing; the higher market-value of the sugar compensating for the incomplete extraction of the juice. In many factories, the power of the evaporator in use determines the maximum quantity of water that can be used for saturation, until a larger evaporator can be installed. The appliances used for saturation will be described in the following chapter.

The effect of pressure between the rollers must now be considered further. Theoretically, the fibre should remain under pressure sufficiently long to allow the juice to escape from it, but this would necessitate slow rotation of the mill-rollers, and reduce the quantity of cane crushed per hour. Formerly, the surface-speed of the rollers did not exceed 16 feet per minute; but, in modern mills, the roller-speed is from 20 to 26 feet per minute, with a corresponding reduction in the depth, or thickness, of the feed. This practice is justified by the following considerations:—

(1) Cane-fibre possesses considerable elasticity, thus resisting compression, and expanding as soon as the pressure is removed. A thick feed consists of numerous superimposed layers, and the exterior layers (in direct contact with the rollers) are more highly compressed than the intermediate, or central layers. Hence, more uniform compression is obtained with a thin feed.

(2) The horizontal distribution of the fibre along the co-acting rollers is never uniform, consequently, the pressure is concentrated on the points where the feed is thickest and is proportionally reduced at all other points. This irregular distribution cannot be entirely eliminated, but is less marked in the case of a thin feed.

(3) The expansion of the fibre, immediately after compression, enables it to absorb juice from the wet surfaces of the lower rollers; thus re-uniting part of the juice and fibre previously separated by pressure. This expansion and absorption increases with the thickness of the feed, and will be illustrated in the following chapter.

(4) When saturating the bagasse with water or dilute juice by means of spraying pipes, the distribution of the added

liquid throughout the bagasse is inversely proportional to the thickness of the feed, because the uppermost layers of fibre protect the underlying layers from the descending spray of liquid.

These practical considerations have led to reducing the thickness of the feed, and increasing the surface-speed of the rollers in order to crush a large tonnage of cane per hour.

CHAPTER VI

MILLING MACHINERY AND MODE OF OPERATING

Introductory Note

A SATISFACTORY description of sugar machinery, and the numerous problems involved in its design, would probably require two or more volumes. The aim of the present work is to describe how machinery is employed in order to obtain certain practical results; and, for this purpose, it is sufficient to describe only the more important parts of machines, and to employ illustrations containing the fewest possible details. The reader will be referred to other works, where mechanical details are fully described and illustrated.

THE MILL

The modern cane-mill is built up of several similar units, one of which is shown in section in Fig. 6, and comprises the following more essential parts. Top-roller T; front, or feed-roller F; back, or bagasse-roller B; and rigid "trash turner," or "trash-plate," P. The word "trash" formerly applied to the crushed cane (bagasse or megass), is now applied to the dead cane leaves, which do not enter the mill.

After being crushed between the top- and front-rollers, the bagasse is forced across the rigid trash-plate by the rotary motion of the top-roller, until it is gripped between the top- and back-rollers. The top-roller therefore operates twice as a crusher, and also as a mechanical transporter between the two crushings.

Although numerous other roller-combinations have been designed and tried, this three-roller type is still preferred and has been in use for over a century. It was the cane-mill of former days, but now represents a unit of the multiple

mill. Two such units form a "double-crushing mill"; three units, a "triple-crushing mill," and so on. But, since each unit applies two pressings, a multiple mill is more correctly defined by the total number of rollers acting together; thus, three units form a nine-roller mill, and four units a twelve-roller mill.

The first unit operates under unfavourable conditions

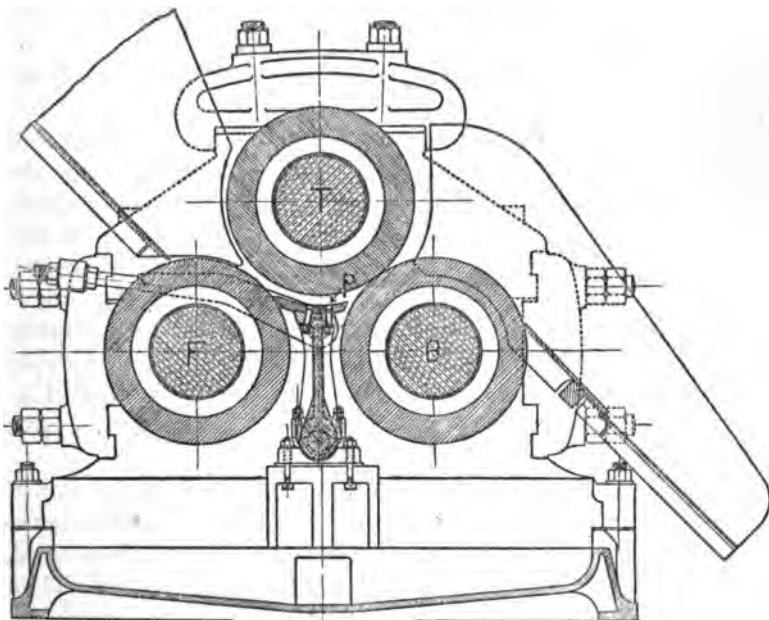

FIG. 6.—VERTICAL SECTION OF THREE-ROLLER MILL

unless the canes be first reduced to small pieces by passing through one of the following appliances, producing a more compact and uniform feed to the first mill-unit.

(1) *The "Cutter."*—This apparatus consists of numerous curved knives, about 12 inches in length, mounted radially and spirally on a horizontal shaft, which rotates at a speed of about 300 revolutions per minute. The canes are thus cut up into small pieces, but no juice is extracted until pressure is applied in the mill.

(2) *The "Shredder"* tears the cane into strips, and one form of apparatus consists of two horizontal rollers, constructed of V-shaped rings shrunk upon a central cylinder; the rings on one roller interlocking with those on the other. One roller rotates at a speed of 250 revolutions per minute, and the other at 500 revolutions. Very little pressure is applied, and no juice is extracted.

A more recent type—The "Searby Shredder"—has a horizontal shaft carrying steel beaters, which force the cane against stationary bars with cutting-edges.

(Illustrations of the "Cutter" and "Shredder" will be found in Deerr's *Cane Sugar*, p. 192.)

(3) *The "Crusher."*—This is a two-roller mill, the rollers of which rotate at equal speeds but somewhat faster than the rollers of the first mill-unit. Both rollers have deeply corrugated surfaces, forming V-shaped "teeth"; the teeth on one roller interlocking with those on the other, thereby cutting the canes into short lengths. At the same time, the cane is squeezed flat between the two rollers, and a large quantity of juice is extracted. The standard type is the "Krajewski Crusher," shown in position in front of the first mill-unit, in Fig. 7, and also seen in Figs. 8 and 9. Other patents have been taken out for grooves of various designs.

The most usual combination for a multiple mill consists of a "Crusher," followed by three mill-units; or a total of eleven rollers (Fig. 8). Fourteen-roller mills are also much used, and a general view is shown in Fig. 9. In a modern Cuban factory, two sets of "Crushers" are followed by six mill-units, forming a twenty-two-roller combination.

MILL-ENGINE AND GEARING

Driving-power is transmitted from the steam-engine to a train of toothed gearing-wheels, and from the latter to the projecting gudgeon of each top-roller by means of "coupling-boxes," which permit a slight displacement of the roller relative to the attached driving-shaft. This rotary motion of each top-roller is, in turn, transmitted to the two lower rollers of each mill-unit by toothed gearing.

Thus, a single engine can drive a combination of eleven

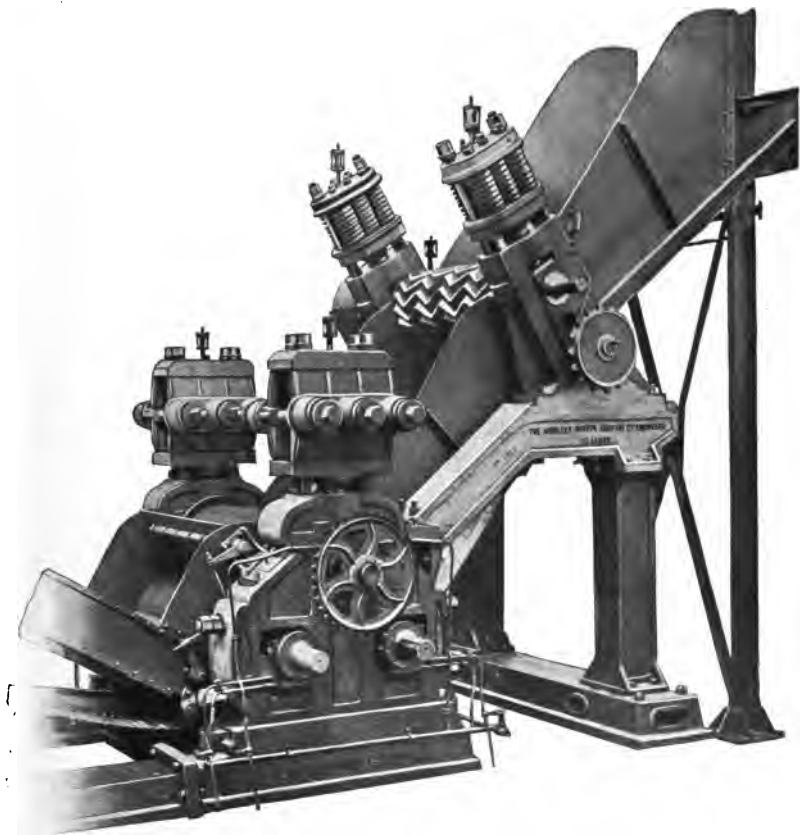

FIG. 7. KRAJEWSKI CRUSHER AND FIRST MILL-UNIT.



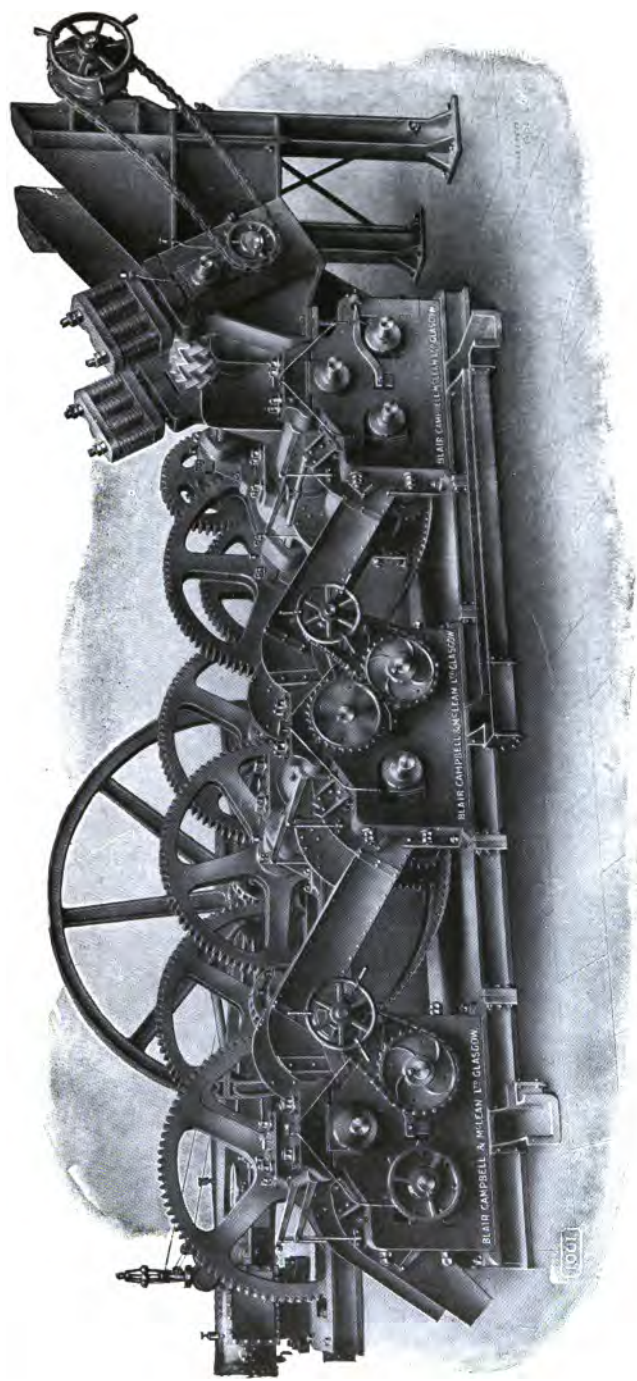

FIG. 8. ELEVEN-ROLLER MILL, WITH GEARING AND SINGLE ENGINE.





FIG. 9. FOURTEEN-ROLLER MILL.



rollers, as shown in Fig. 8, the motion of the engine being transmitted to four parallel shafts, three of which are "coupled" to the top-rollers of the mill-units, and one to the "Crusher."

The gearing-wheels act as powerful levers, converting the high speed and low intensity of the engine's work to a low speed and high intensity of the mill-work, or from about 50 revolutions in the engine, to about $2\frac{1}{2}$ in the mill-rollers. In a fourteen-roller mill, the crusher and first and second units are usually driven from one engine, and the third and fourth units from a second engine. An additional unit can be added either to the first pair, to the second pair, or to both, without requiring an additional engine.

Electric motors are now frequently adopted for driving cane-mills, and offer certain advantages over the steam-engine, which need not be considered here.

Pressure Appliances

In the earlier mills, the rollers rotated in rigid, or fixed bearings; and the pressure applied was proportional to the thickness of the feed, relative to the apertures between the rollers. The feed tended to thrust the rollers apart, thus causing "internal pressure," which was resisted by the "headstocks," which carried the roller-bearings. In modern mills, the roller-bearings are capable of sliding-motion in suitable guides, and "external pressure" is applied to the two bearings of a roller, thus applying any desired pressure between two co-acting rollers. This system has the following advantages:—(1) The pressure applied is independent of the thickness of the feed, and therefore more uniform. (2) The pressure can be varied at will. (3) Should pieces of metal enter the mill, accidentally (or otherwise), the sliding bearings yield under the abnormal strain, and allow the metal to pass through without breaking the rollers.

This "external pressure" is applied by means of the following appliances:—

(1) *The Toggle Apparatus*.—Each bearing of the top-roller is thrust downwards by a ram connected to double

toggle-levers, actuated by powerful springs. Under excessive "internal pressure," the top-roller can lift by forcing the toggle-levers against the springs. As soon as the "internal pressure" is reduced, the "external pressure" (due to the levers and springs) forces the roller downwards to its normal position.

(2) *The Hydraulic Apparatus.*—The pressure apparatus stands at a little distance from the mill, and pressure is transmitted by means of water or oil in pipes from the small ram on the hydraulic-accumulator to larger rams acting on the roller-bearings. In this system, the mill is converted into a hydraulic-press, which operates continuously, and the external hydraulic-pressure can be applied to any single roller of each mill-unit. When applied to the top-roller (as is the Toggle Apparatus), the roller can only lift by forcing the ram upwards, thus driving the fluid (behind the ram) back to the pressure-apparatus or "accumulator." Such motion is resisted by a number of iron weights attached to the "accumulator," and the sum of these weights multiplied by the ratio of area of mill-rams to area of accumulator-ram represents the pressure acting on the roller-bearings. As soon as the "internal pressure" is reduced, the "external hydraulic pressure" forces the roller back to its normal position.

(The Toggle and Hydraulic Appliances are fully described and illustrated in *The Manufacture of Cane Sugar*, by Scard and Jones, pp. 47-54.) The Toggle Apparatus is shown on first mill-unit in Fig. 7 of this work.

Grooving of Mill-rollers

The absorption of juice by the expanding fibre, immediately after compression, was referred to in the last chapter, and is illustrated in Fig. 10.

$D_1 D_2$ = point where pressure begins.

C = point of maximum compression.

$E_1 E_2$ = point where pressure ceases.

Then, increasing pressure from D to C forms the entering wedge of fibre $D_1 C D_2$, and increasing expansion of fibre from C to E forms the leaving wedge $E_1 C E_2$. These two

wedges, on opposite sides of the point C, are continuously re-formed whilst the mill is in action.

The leaving wedge of expanding fibre readily absorbs juice from the wet surface of the back-roller. As the extraction of

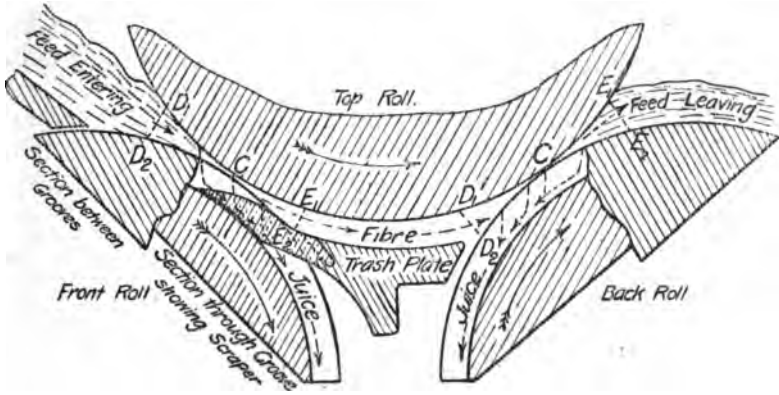

FIG. 10.—MESSCHAERT GROOVING OF ROLLERS
(Vertical Section)

juice begins at D_1D_2 , and reaches its maximum at the point C, the extracted juice should escape over the surfaces of the front- and back-rollers, but is obstructed by the entering wedges of fibre D_1CD_2 . The imprisoned juice now acts as

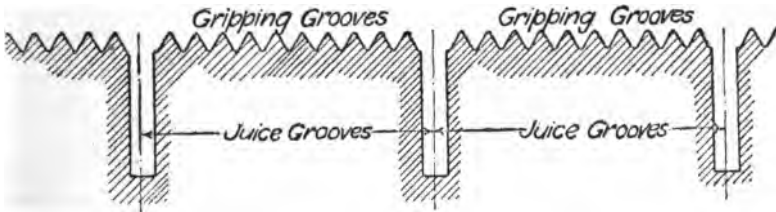

FIG. 11.—MESSCHAERT GROOVING OF ROLLERS
(Longitudinal Section)

a lubricator, causing the rollers to "slip" instead of gripping the feed, and the work is retarded. Having no free outlet, the juice may be carried past the point C, and is then completely absorbed by the leaving wedge of expanding fibre. In the last unit of a multiple mill, the juice frequently

spurts upwards with explosive violence, after passing between the top- and back-rollers.

Messchaert's Grooving.—This system eliminates the foregoing defects of "slip" and "absorption" by means of "juice-grooves" cut in the lower rollers, each groove forming a separate channel through which the extracted juice can pass *below* the wedges of fibre, in the direction of the dotted arrows (Fig. 10).

A longitudinal section through the lower roller is shown in Fig. 11; the juice-grooves being at a uniform pitch over the

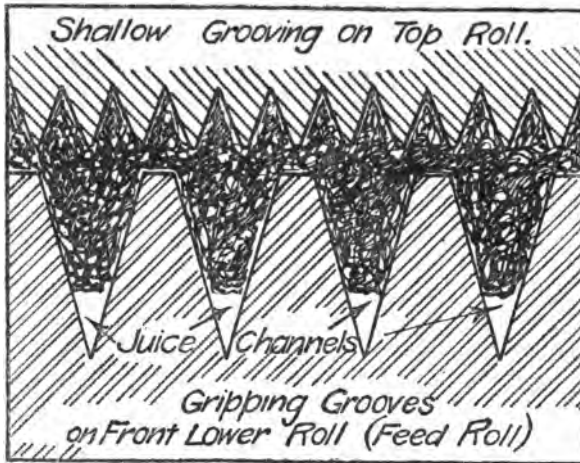

FIG. 12.—HIND-RENTON GROOVING OF ROLLERS

entire length of the roller. The pitch and dimensions of the grooves are made to suit the position of the roller, or quantity of juice extracted by it.

Hind-Renton Grooving has a different object from the foregoing, being mainly designed to assist the rollers to grip the feed, and thus ensure a maximum quantity of cane crushed per hour. Gripping-power was formerly obtained by employing special foundry mixtures producing a coarse texture on the roller-surface; also by shallow transverse grooves, as shown on the top-roller, in Fig. 12.

The Hind-Renton grooving is here shown on the lower or

feed-roller. Under compression, the fibre is forced into the V-shaped grooves, which thus act as gripping-points, but the fibre does not completely fill the grooves. The empty space at the apex of each groove forms a channel for the escape of the extracted juice. This type of grooving is only applied to the front or feed-roller, whereas, the Messchaert grooving is equally applicable to the back- or bagasse-roller. The two systems of grooving co-operate in overcoming the practical defects of plain rollers.

Apparatus for "Saturation."

Three methods of saturating the fibre with water, during milling, are:—

- (1) Spraying, or Imbibition.
- (2) Injection of water under pressure, whilst the fibre is under compression.
- (3) Immersion of the fibre under water, in suitable baths placed between the mill-units.

(1) *Spraying, or Imbibition.*—This is the simplest and more general method, requiring only a perforated spraying-pipe, extending parallel to each top-roller, and somewhat behind it.

The spray of water falls upon the fibre as it emerges from between the top- and back-rollers, but Fig. 10 indicates that the water-spray cannot penetrate to the wedge of expanding fibre, E_1CE_2 (where it would be instantly absorbed), but falls upon the fully expanded fibre, the upper layers of which become saturated before the lowermost layers become wetted. The fully expanded fibre resembles a moist sponge filled with air, and this enclosed air prevents the added water from penetrating freely into the porous cellular material.

The spraying method is somewhat defective, but has the following practical advantages:—(a) The mill-units can be placed close together and driven from a single engine, which ensures the most favourable conditions for multiple crushing, and also economises floor-space. (b) The compressed blanket of fibre passes from one mill-unit to the following unit without being broken up, and is therefore

easily gripped and still further compressed, thus ensuring smooth running of the entire milling plant.

"Double" and "compound" imbibition are effected as explained in the previous chapter. But, when diluted juice is to be sprayed, it is preferable to employ open troughs of V-section, in place of the perforated pipes, because the perforations in the latter soon become choked with fine particles of fibre (cush-cush) contained in the juice. The continuous overflow of juice from the open troughs distributes the liquid over the fibre passing beneath it.

(2) *Injection of Water while the Fibre is under Compression.*

—This method is adopted in *Ramsay's Patent Macerator*. The compressed fibre, escaping from between the rollers, passes through a narrow inclined channel, forming an extension of the aperture between the rollers. Water is admitted to this channel under pressure, both above and below the moving blanket of fibre; after which the latter emerges from the enclosing channel, and is conveyed to the following mill-unit. The saturating-channel consists of two parallel plates (or scrapers), the lower extremities of which are pressed into contact with the top- and back-rollers, respectively, by means of springs. A special type of transporter is required to convey the fibre to the following mill.

Even in this arrangement, considerable expansion of the fibre must occur before it reaches the point where water (or dilute juice) is injected, for the channel between the "scrapers" must necessarily be sufficiently large to allow the fibre to slide upwards without excessive friction. The Ramsay Macerator has given satisfactory results in numerous factories in Hawaii, and represents a distinct advance on the old method of spraying.

(3) *Immersion of the Fibre in Baths.*—Although the terms "saturation" and "maceration" are now constantly applied to spraying or imbibition, they were formerly restricted to the method now to be described. The apparatus consists of a shallow trough or bath, of the same width as the mill, but from 20 to 25 feet in length. The crushed fibre is carried through this bath by means of a special type of transporter, and discharged into the following mill-unit at the rear end of

the bath. In "single saturation" (see p. 37), the bath is placed in front of the last mill. In "double saturation," a second bath is placed in front of the last mill but one. In "compound saturation," there may be three baths. The method of operating a single bath is as follows. The bath is filled with fresh water when the mill is started. After the crushed fibre has been passing through the bath for some time, the water becomes sweet and increases in density, owing to the juice washed out of the fibre. When the density rises to a certain figure (representing very diluted juice), a continuous stream of water is added at the rear end of the bath, causing an overflow of sweet water at the front end. The water therefore moves slowly along the bath in a contrary direction to the fibre under treatment, the added water being just sufficient to maintain a low density in the bath during the period that the mill continues working. The quantity of water entering the bath per hour (or % of canes crushed) is no greater than in the methods previously described. The dilute juice extracted by the mill behind the bath has a higher density than the liquid in the bath itself, and passes into the factory along with the rich juice extracted by the dry-crushing mill in front of the bath.

In "compound saturation" (see p. 38), the last mill juice is pumped into a bath placed behind the first mill and serves for saturating the dry-crushed fibre. Fresh water is only added to the bath in front of the last mill, thus reproducing the conditions of "compound imbibition" previously described.

Although the immersion method appears to ensure complete wetting of the fibre, and, consequently, the maximum dilution of the contained juice before re-crushing, it is now little used for the following reasons:—

1. The mill-units must be far apart, necessitating separate engines to drive each unit.
2. The compact feed, leaving the rollers of the dry-crushing mill, is broken up and loosened during its motion through the bath, owing to the type of transporter employed.
3. The fibre is fully expanded when it enters the bath.

and the contained air prevents the saturating liquid (water or dilute juice) from penetrating to the interior of the coarse fragments of bagasse.

4. On emerging from the bath, the fibre is not readily gripped by the following mill (unless the rollers are specially grooved). The material must then be forced between the rollers by manual labour, or by mechanical "pushers" designed for this purpose.

Formerly, steam was largely used in conjunction with water-spraying, for saturating the bagasse. By condensing on the fibre, steam acts in the same manner as hot water, and is attended by the same disadvantages (see above).

CHAPTER VII

CAPACITY AND EFFICIENCY OF MILLS

THE results obtained in practice may be considered under two heads ; namely, the quantity of work done per unit of time, or "mill-capacity"; and the quality of the work done, or "mill-efficiency."

(a) MILL-CAPACITY

This is now crudely expressed as—tons of cane crushed per day, or per hour. As the same mill does more work when crushing soft canes, rich in juice, than when crushing hard canes, this figure is of little value when comparing the work done in different factories. A more rational basis for comparison was proposed by Lely in the following words :—"It would be more to the point to record the tons of bagasse (crushed cane) produced per hour ; or, to be more accurate, the tons of dry fibre crushed per hour."

In any multiple mill, the tons of dry fibre crushed per hour in the first unit is the same for all the following units ; consequently, the capacity of this first unit indicates the capacity of the whole multiple mill. But, as the first unit applies the lowest pressure, the function of the following units is to increase the efficiency without modifying the capacity. The last unit, which applies the maximum pressure, may therefore be termed the "efficiency-unit." In order to illustrate these definitions, consider the case of a nine-roller mill, composed of units A, B, and C, to which it is proposed to add another unit D.

Case 1. D is used as the fourth, or last unit ; A, B, and C continuing to operate as before. The pressure applied in D may now be greater than in C, in order to obtain increased

extraction. The added unit also permits of an additional saturation between C and D, thus further increasing the efficiency. But the capacity of the whole plant is determined by unit A, and remains unchanged.

Case 2. D is used as first unit (in front of A), and the pressures applied in A, B, and C remain as before. The roller-apertures in D may be opened so as to admit more fibre per hour than previously entered A, compressing same to a volume which can now enter A, and pass on to B and C. In this case, the capacity of the whole plant is increased; whilst the efficiency, due to the maximum pressure applied in unit C, remains unchanged. But, some increase in efficiency is possible by saturating the fibre between D and A, as well as between A and B, and B and C. The above result would, of course, be obtained by using D as the last unit and increasing the roller-apertures in the units A, B, and C, so as to admit more fibre per hour to A; the pressure applied in D being equal to that previously applied in C.

Case 1 would be adopted when increased efficiency is more urgent than increased capacity, and Case 2 represents the reverse conditions. But, in either case, increased efficiency can be combined with increased capacity by suitably adjusting the roller-apertures and pressures in the four units. Since the "crusher" prepares the canes for pressure in the first unit, this combination of five rollers represents the "capacity-unit" of the multiple mill, and varies in different factories as regards length, and surface-speed of mill-rollers. We propose a common basis for comparison in the product of these two variables, giving the "crushing-surface" per hour, and mill-capacity might then be defined as:—pounds of dry fibre crushed per sq. ft. crushing-surface per hour in the first unit. This is illustrated in the following example.

Dimensions of rollers	= 34 × 78 inches
∴ length	= 6·5 feet
Surface-speed in first unit	= 13 feet per minute
	= 780 feet per hour
Dry fibre crushed per hour	= 8·12 tons
	= 16240 pounds

$$\begin{aligned}
 \text{Then crushing-surface per hour} &= 6.5 \times 780 \\
 &= 5070 \text{ sq. ft.} \\
 \text{and mill-capacity} &= \frac{16240}{5070} \\
 &= 3.2 \text{ pounds fibre per sq.} \\
 &\quad \text{ft. per hour.}
 \end{aligned}$$

This method of expressing mill-capacity is not in use, but a close approximation to it is found in a report of the "Ewa Factory," Hawaii:—"The mill crushed $1\frac{1}{2}$ tons of fibre, or 9.7 tons of cane, per lineal foot of roller per hour."

(b) MILL-EFFICIENCY

The useful work performed is the separation of liquid (juice) from solid fibre, and the result may be stated in two ways:—

(a) Weight of juice extracted, % on total juice in cane entering mill.

(b) Weight of unextracted juice, % on crushed fibre leaving mill.

Method (a), or "Extraction."—If the liquid portion of the cane were of uniform composition, it is obvious that the percentage of extracted juice on total juice in cane, would also represent the percentage of extracted sucrose on total sucrose in cane. But, as was explained in Chapter III, the saccharine juice is stored in the soft parenchyma cells of the cane, whilst the harder tissues contain impure juices, in which little or no sucrose is present, and which are only extracted under heavy pressure. Hence, the unextracted portion of juice contains less sucrose than the extracted portion; and the extraction of actual sucrose is about 3.0% higher than the figure representing extraction of juice.

The term "extraction" is defined as:—weight of sucrose extracted % on total sucrose in canes entering mill. Consider the case of a fourteen-roller mill, treating average canes, containing 12% fibre and 88% total juice. The sucrose extracted in each mill-unit is approximately as follows:—

Crusher and first unit	= 80%	= dry-crushing
second unit	= 5%	}
third "	= 5%	
fourth "	= 5%	
	= 5%	

Total extraction = 95% of sucrose present in cane crushed.

The very high extraction in the first unit is clearly due to the large quantity of juice (in the form of cane) entering that unit, whereas the following units deal with a material containing little juice, and the highest pressure, applied in the last unit, extracts only 5% of the total sucrose. The full power of the mill (pressure combined with saturation) is required to bring the extraction up to 95% by extracting the final units. An extraction of only 90% would be considered bad work for this particular mill, yet five additional units represent good work; so that the "scale of efficiency" lies between 90 and 95. The maximum extraction yet claimed is 98.4% at the "Ewa Factory," Hawaii, with a combination of 20 rollers and the addition of saturation water equivalent to 34.2% dilution of normal juice.

Method (b) or Weight of Unextracted Juice % on Crushed Fibre leaving the Mill.—This mode of measuring mill-efficiency was proposed by Lely, and is illustrated below by means of the previous example.

	Fibre.	Juice =	Ratio of Juice to 100 parts of Fibre present.
Canes entering first unit contain . . .	12	88 =	733
After crushing in first unit . . .	"	17.6 =	147
" " second unit . . .	"	13.2 =	110
" " third " . . .	"	8.8 =	73
" " fourth " . . .	"	4.4 =	37

The smaller the ratio of unextracted juice to 100 parts of fibre in last mill, the greater is the efficiency of the whole mill.

The two methods, (a) and (b), may now be contrasted as under :—

	Method (a). Sucrose extracted per 100 Sucrose in Cane.	Method (b). Unextracted Juice per 100 Crushed Fibre.
After crushing in first unit . . .	80	147
" " second unit	5	110
" " third "	5	73
" " fourth "	5	37
	Sucrose extracted } = 95%	Juice lost in bagasse } = 37

By method (a) the first unit is far more efficient than the following units, yet applies the lowest pressure. The second, third, and fourth units appear to be of equal efficiency, although the pressure increases in each. The percentage extraction is greatly influenced by the ratio of juice to fibre in the original cane; and, to some extent, by the physical properties of the fibre when treating different varieties of cane.

By method (b) there is a uniform increase in efficiency from the first to the last unit, corresponding to the increasing pressures in the different mill-units, and to the displacement of juice by the added maceration water. The result obtained by this method is independent of the percentage of juice and fibre in the original cane, but is influenced, to some extent, by the physical properties of the fibre when treating different varieties of cane; it being impossible to eliminate this factor.

Of these two methods of measuring mill-efficiency, we prefer Lely's, in which the following calculations are required:—

Let A = undiluted juice extracted by "dry-crushing" in first unit (or in crusher and first unit).

Let B = juice (of same sucrose-content as A) which fails to be extracted, and is therefore lost in the bagasse leaving last mill-unit.

$$= \frac{\text{Per cent. sucrose in final bagasse} \times 100}{\text{Per cent. sucrose in A}}$$

Then "mill-efficiency" = $\frac{B \times 100}{\text{Per cent. fibre in final bagasse}}$.

The calculation of B requires a word of explanation. The final bagasse consists of fibre + unextracted maceration water + unextracted juice; the two latter being present as unextracted diluted juice. The proportion of undiluted juice must therefore be calculated, as shown. But, as previously stated, A contains a higher percentage of sucrose than the unextracted portion of juice B, left in the final bagasse; so that the formula can only yield approximate values, and we propose the following modification:—"mill-efficiency = weight of unextracted sucrose per 100 parts of dry fibre leaving mill"; calculated by the formula:—

$$\frac{\text{Per cent. sucrose in final bagasse} \times 100}{\text{Per cent. fibre in final bagasse}}$$

The foregoing definitions of mill-capacity and mill-efficiency are here brought together :—

Capacity, or quantity of work done =	(a) tons of cane crushed per hour.
	(b) „ „ dry fibre crushed per hour.
	(c) pounds of dry fibre crushed per sq. ft. of crushing-surface, per hour, in first unit.
Efficiency, or quality of work done =	(a) sucrose extracted as juice per 100 sucrose in cane.
	(b) unextracted juice per 100 fibre leaving mill.
	(c) unextracted sucrose per 100 fibre leaving mill.
Saturation, or maceration	= (a) water added per 100 of canes crushed.
	(b) „ „ „ „ dry fibre crushed.

The three definitions marked (a) are in general use. Those marked (b) were proposed by Lely, but are not yet generally adopted; and some authorities reject his formula for mill-efficiency. The definitions marked (c) are modifications of Lely's definitions, suggested by the present writer.

As efficiency is the combined result of pressure between the rollers and saturation of the bagasse between the mill-units, the relative efficiencies of different mills can only be judged by taking both factors into consideration. Lely has attempted to combine these two factors in a single formula, which he terms "A Universal Figure for Mill Performance," based on the following reasoning.

The published records of Java factories, extending over many years, indicate that the "Sucrose-Loss Quotient," or

$$\frac{\text{Sucrose lost in bagasse } \% \text{ on cane} \times 100}{\text{Sucrose } \% \text{ in cane}}$$

is fairly constant; whether the canes treated be hard and fibrous, or soft and juicy. With good millwork, this quotient is equal to 60, when 15% of saturation water is added per 100 of cane (average quantity in Java factories), equivalent to $\frac{15 \times 100}{12} = 125$ parts of water per 100 parts of dry fibre in canes.

The standard for good millwork in Java may therefore be stated in two terms :—

$$\begin{aligned} \text{Sucrose-Loss Quotient} &= 60 = \text{Unit of "Mill Performance"} \\ \text{Saturation per 100 fibre} &= 125 = \text{Unit of Saturation.} \end{aligned}$$

Let a particular mill in some other country give the following results :—

$$\text{Sucrose-Loss Quotient} = x$$

$$\text{Saturation per 100 fibre} = y$$

$$\text{Then "Standard loss" (relative to Java)} = x \times \frac{y}{125}$$

$$\text{and "Mill Performance"} = \frac{xy}{125} \div 6$$

It is here assumed that x is inversely proportional to y . Consequently, if y be greater or less than 125, x must be reduced, or increased, respectively, in order to compare with the standard practice in Java. The formula is illustrated in the following examples :—

	Normal Saturation. (Java Practice.)	Heavier Saturation.	
		14°0	14°0
Sucrose % in canes	14·0	14°0	14°0
Sucrose lost in bagasse % cane	0·84	0·70	0·56
Sucrose-Loss Quotient	6·0	5°0	4°0
Saturation per 100 fibre	125·0	150°0	187·5
"Standard loss"	6	6	6
"Mill Performance"	1	1	1

With increasing saturation, the Sucrose-Loss Quotient diminishes from 6·0 to 4·0, but the "Standard Loss" and "Mill Performance" are constant. Lely claims that his formula permits of "a reliable comparison between mills in different countries; and that a figure below unity indicates superior work, whilst anything above unity indicates inferior work." This formula has the advantage of simplicity, but requires to be thoroughly tested before its reliability can be accepted as proved.

The methods of calculating the capacity and efficiency of mills will be more fully considered in Chapter XV (pp 146-147).

The engineer may regard the mill and its engine (or engines) as a machine for converting steam-power into useful work; and, in this wider sense, Efficiency may be defined as the quantity and quality of the work done, relative to the indicated horse-power. It being impossible to combine all

these factors in a single formula, it is desirable to record the following particulars:—

- Number of rollers employed.
- Variety of cane crushed.
- Percentages of fibre in canes and in final bagasse.
- Quantity of saturation water used.
- Percentage dilution of "normal juice."
- Mill-capacity, or quantity of work done per hour.
- Mill-efficiency, or quality of work done.
- Average steam-pressure in boiler.
- Average indicated horse-power of engine.

The following results were obtained with an eleven-roller mill, during a "trial run" of 23 hours.

Details of Mill

Krajewski Crusher followed by three mill-units.
 Two Krajewski rollers = 72×26 in. diam. Surface-speed = 28 ft. per minute.
 Nine Mill-rollers = 78×34 in. diam.

	<i>1st unit.</i>	<i>2nd unit.</i>	<i>3rd unit.</i>
Apertures between top and front rollers =	$1\frac{1}{8}$ in.	$\frac{5}{8}$ in.	$\frac{5}{8}$ in.
" " " back " =	$\frac{1}{8}$ "	$\frac{1}{4}$ "	$\frac{1}{8}$ "
" " top roller and trash-plate =	2 "	$1\frac{1}{2}$ "	$1\frac{1}{4}$ "
" " rear of trash-plate and } =	$1\frac{1}{4}$ "	1 "	$\frac{3}{4}$ "
" " back roller			
Surface-speed of rollers, feet per minute =	20	23	26
Hydraulic Pressure on top rollers, tons =	230	320	400

Details of Engine

Cylinder, 30 in. diam. Stroke = 60 in.
 Revolutions from 44 to 54 per minute.
 I.H.P. = with boiler-pressure of 83 lbs., and 48 revolutions per minute =
 Maximum 411, Minimum, 207.6, Mean, 320.

Mill-Capacity = 50.28 tons of cane = 6.03 tons fibre, crushed per hour.

Mill-Efficiency = 93.4% sucrose extracted on total sucrose in canes.

Dilution of Normal Juice = 18% by volume.

Analytical Data

Percentage of fibre in canes = 11.99.
 " " water in final bagasse = 45.3.
 " " sucrose in final bagasse = 5.0.
 Density of juice extracted by crusher and first unit = 20.8 Brix.
 " " " third, or last unit = 12.3 "

The influence of the number of mill-units on Capacity and Efficiency may be seen on comparing this mill with a more

powerful combination of a Krajewski Crusher followed by six three-roller units at the Ewa Factory, Hawaii.

	11-roller Mill.	20-roller Mill.
Tons of fibre crushed per hour	6.03	8.12
Sucrose extracted % total sucrose in canes	93.4	98.4
Dilution of normal juice due to saturation	18%	34.1%

CAPACITY *versus* EFFICIENCY

A factory is designed to operate efficiently when treating a certain tonnage of cane per day, this tonnage representing the "normal capacity" of the whole factory. Should this "normal capacity" not be reached, there will be ample evaporating power to allow of heavier saturation during milling, thus increasing the mill-efficiency beyond the "normal." On the other hand, should the "normal capacity" be exceeded, an excess of juice has to be evaporated, and the quantity of saturation water per 100 of cane (or per 100 of fibre) must be reduced to enable the evaporator to keep pace with the mill. The mill-efficiency now falls below the "normal efficiency."

In modern factories, the extraction of sucrose by milling has reached a point where increased efficiency may be unprofitable when every factor is taken into account. The practical man has to decide what degree of efficiency will pay him best, and must consider (a) the cost of canes delivered at the factory, and (b) the market price of sugar. The problem may be studied in the following form.¹

- Let W = weight of cane crushed in hundreds of tons.
 " Y = yield of commercial sugar % on canes.
 " S = selling price of sugar per ton.
 " C = cost of canes per 100 tons.
 " M = cost of manufacture per 100 tons of cane.
 Then WY = tons of commercial sugar made.
 " SWY = market value of sugar made.
 " WC = cost of canes.
 " WM = cost of manufacture.

¹ "Notes on the Sugar Industry of Cuba"—*International Sugar Journal*, vol. xviii, p. 363.

When the price paid for canes is not proportional to the varying market price of sugar, the profits are represented by :—

$$SWY - WC - WM \quad \text{or} \quad W \{SY - (C + M)\}$$

or, cost of canes + cost of manufacture are deducted from the selling price of sugar made.

The planter, or cane-farmer, who sells his crop to a factory, naturally desires to benefit when sugar rises in value. Hence, canes are sometimes purchased on a sliding-scale based on the current price of sugar.

Let P = a small percentage of the price of sugar, paid for 100 tons of cane.

Then SP = cost of canes per 100 tons
and SPW = cost of canes crushed. Substituting this value for WC (above), the profits are represented by :—

$$SWY - SPW - WM \quad \text{or} \quad SW (Y - P) - WM$$

where $Y - P$ indicates that the canes are paid for out of the sugar extracted therefrom.

Assume that the price of cane rises above (C) in first formula, or above (P) in second formula, whilst the selling price of sugar (S) remains constant. Then, in both cases, the profits must fall unless either (W) or (Y) are increased proportionally.

An increase in W = increase in mill-capacity per hour.

“ “ Y = “ “ mill-efficiency, or more sugar extracted from a given weight of cane.

The following illustrations are taken from pre-war conditions in Cuba. Consider two similar factories, buying the same canes on the same sliding-scale of 5% of price of sugar, the latter being \$40 per ton. Factory A aims at efficiency, or highest possible extraction. Factory B aims at crushing the highest possible tonnage of cane per day, with lower efficiency than factory A, thus :—

A crushes 100,000 tons of cane, and produces 12,500 tons of sugar (= 12.5% on cane).

B crushes 150,000 tons of cane, and produces 16,500 tons of sugar (= 11.0% on cane).

As A extracts more sugar per ton of cane, the cost of manufacture is \$1.62 compared with \$1.38 in B. Substituting

these assumed figures in the last formula, we can ascertain the effect of increasing the price of cane from 5% to 6% and 7% of the price of sugar (\$40 per ton).

	5%	6%	7%
Profits in Factory A . . . =	\$138,000	\$98,000	\$58,000
„ „ B . . . =	153,000	93,000	33,000
Advantage	B = 15,000	A = 5,000	A = 25,000

As might be expected, with cheap canes, capacity is more profitable than efficiency; but, as the cost of canes rises, efficiency becomes more and more profitable. Next, assume that the price of sugar rises from \$40 to \$60 per ton, and that this higher value is adopted in the sliding-scale purchase of canes.

	5%	6%	7%
Profits in Factory A . . . =	\$288,000	\$228,000	\$168,000
„ „ B . . . =	333,000	243,000	153,000
Advantage	B = 45,000	B = 15,000	A = 15,000

Here, capacity is much more profitable when canes are purchased at 5% of sugar-price, but rapidly diminishes as the cost of canes increases. When canes cost $6\frac{1}{2}\%$ of sugar-price, capacity and efficiency become equally profitable, whilst at 7%, efficiency is more advantageous.

CHAPTER VIII.

OTHER METHODS OF JUICE-EXTRACTION

2. THE DIFFUSION PROCESS

FORTY years ago, two rival methods of extraction were in vogue:—the ancient method of milling, and the diffusion process, borrowed from the beet-sugar industry. As much more sugar could be extracted from the cane by diffusion than by the mills then in use, the new process was adopted with considerable success in Demerara, Java, Hawaiian Islands, Mauritius and India. Although subsequently abandoned, it established an "ideal extraction," which led to the rapid improvement of the older milling process in two directions; namely, the adoption of multiple mills, and the combination of milling (or pressure) with saturation or washing of the bagasse, either during milling or subsequently.

The diffusion process, being the standard method of extracting sugar from the beet, will be described in the following chapters; the apparatus used, and mode of operating, being the same for cane and beet. Here, it will be sufficient to explain why cane-diffusion has been abandoned in favour of multiple-milling and saturation.

(1) The cane stem differs from the beetroot in yielding a by-product (bagasse) rich in fibre, and available as fuel. The peculiar advantage of the milling process is that the extraction of the juice is accompanied by the drying of the crushed fibre, no subsequent drying process being required. The diffusion process leaves the fibre completely saturated with water, and to extract this water, a powerful mill is required in addition to the costly diffusion apparatus.

In the beet-sugar factory, the diffusion-slices could not be used as fuel, even after drying, but are sold as fodder, after the bulk of the water has been extracted by pressing. The

beet factory is therefore dependent on coal for steam production.

(2) Even when diffusion of cane is followed by milling, the crushed cane-slices become powdery, and their fuel-value is very inferior to that of bagasse obtained by direct milling of the cane, so that supplementary fuel (wood or coal) becomes necessary.

(3) The diffusion battery must operate day and night without stoppages. This is practicable in the beet-sugar factory because the roots can be stored in large quantities, and the factory is not dependent on the daily arrival of roots from the fields. The cut sugar-cane cannot be stored without loss of sugar; hence cane-diffusion necessitates a daily delivery of cane proportional to the working capacity of the diffusion plant, and any interruption in this daily supply is much more serious than in the case of milling.

(4) The diffusion battery, being operated by hand, requires experienced and highly-paid workmen, not easily obtainable in the tropics. Failure of cane-diffusion has frequently been due to incompetent workmen.

(5) The quantity of cane treated by diffusion in 24 hours is strictly limited by the number and capacity of the diffusers. The milling process is more adaptable, because the rollers can be adjusted to admit more cane per day; for example, when burnt cane has to be crushed without delay; or, again, when a heavy crop has to be crushed before the rainy-season sets in, and transport is interrupted.

(6) The cane stem, being much harder than the beetroot, is more difficult to slice, and the knives of the slicing-machine require to be more frequently sharpened and adjusted.

3 THE PERRICHON PROCESS

This was first employed in Egypt, in 1899. The canes are dry-crushed in a mill, thus extracting a large proportion of undiluted juice. The resulting bagasse is dropped into a number of tanks, mounted on wheels, which move along a tram-line. Each tank holds about $1\frac{3}{4}$ tons of bagasse, and has a perforated false-bottom, raised above the true bottom, and an outlet cock in the latter. Above the tram-line, and

parallel to it, is a line of stationary tanks which supply the washing-liquids to the movable tanks; and, below the tram-line, is a duplicate line of stationary tanks which receive the liquids discharged from the bottoms of the movable tanks.

Calling the overhead tanks A_1, A_2, A_3 , etc.; the movable tanks B_1, B_2, B_3 , etc.; and the low-level tanks C_1, C_2, C_3 , etc., the mode of working is as follows. Hot water flows from A_1 into B_1 , remains in contact with the bagasse for seven minutes, runs off into C_1 , and is then pumped into A_2 . Here it is re-heated, run into B_2 , remains in contact with bagasse for seven minutes, runs off into C_2 , and is then pumped into A_3 . These operations are repeated until the washing-liquid reaches the last low-level tank, say C_9 , and now represents dilute juice of density 6 to 8 Brix. It is pumped from C_9 to the liming tanks where it mixes with, and dilutes the strong juice extracted by the mill.

Every B tank is now moved forward, causing B_2 to come under A_1, B_3 under A_2 , and so on. B_1 is emptied and refilled with fresh bagasse from the mill, and now becomes the last of the series (B_{10}) and is placed below A_9 . Hot water flows from A_1 into B_9 , and the previous operations are repeated until the liquid reaches C_9 , when it is again pumped to the liming tanks.

Every B tank is again moved forward, bringing B_3 under A_1, B_4 under A_2 , etc. B_2 is now emptied, refilled with fresh bagasse, and becomes B_{11} under A_9 , and the operations continue as before. When the work begins, B_1 receives only one washing, and B_8 receives eight, but every subsequent tank receives nine washings (assuming that there are nine A tanks). Consequently, the first washing-liquid entering B_9 has previously passed through eight loads of bagasse; the final washing-liquid entering B_9 is fresh water from A_1 ; and the intermediate washing-liquids contain diminishing percentages of sugar.

Although the Perrichon Process resembles diffusion, there is no true diffusion or dialysis, because the minute cells of the plant have been ruptured by the previous milling of the cane (see Chapter IX). It is merely a washing treatment,

which extracts soluble non-sugars in addition to sucrose. The washed bagasse, discharged from the movable tanks, enters a second mill, which extracts the residual wash-water in order that the bagasse may be used as fuel.

The total extraction (milling + washing) = 96.7% of the total sucrose in the cane; and the washing-liquids, added to the true juice extracted by the cane-mill, causes a dilution of from 15 to 16%.

4. THE GEERLIGS-HAMAKERS PROCESS

This differs from the Perrichon Process in employing a diffusion battery (see Chapter X), instead of movable tanks, for washing the bagasse; the method of operating the battery being exactly the same as in the diffusion of sliced cane and beet (see Chapter XI).

Experiments were carried out in Java, in 1903; the canes being first crushed in a six-roller mill, and the resulting bagasse "washed" in the diffusion battery. No true diffusion or dialysis could take place for the same reason as in the Perrichon Process. After the washing treatment, the bagasse was re-crushed in a three-roller mill, and passed to the furnaces without further treatment.

The total extraction (milling + washing) was 98% of the total sucrose in the cane; and the washing-liquids, added to the true juice extracted by the cane-mill, caused a dilution of 19.6%. This extraction is higher than in the Perrichon Process, and exceeds the extraction now obtained in the majority of multiple mills with heavy saturation during milling.

5. THE HINTON-NAUDET PROCESS

This was first applied to cane-bagasse in 1904, at Messrs. Hinton & Sons' factory, Funchal, Madeira. It resembles the process last described, namely dry-crushing of the canes, followed by washing the bagasse in a diffusion battery. The new feature consists in utilising the diffusers as juice-filters and the bagasse as the filtering medium, as explained below.

The Naudet System of "diffusion with forced circulation" was primarily designed to obtain a higher extraction of

sugar from the beet; the diffusion liquid being pumped from the bottom of a diffuser, through a juice-heater, and returned to the top of the same diffuser. The heated liquid therefore moved downwards through the beet slices within the diffuser, and upwards through the exterior piping and juice-heater; the same treatment being applied to each diffuser, in turn, by connecting the same to the circulating-pump (see p. 100).

In adapting the process to the treatment of cane-bagasse, Mr. Hinton utilised the "forced circulation" for filtering the original juice, previously extracted by the mill, in the following manner. One diffuser at a time is filled with fresh bagasse from the mill, and the previously extracted mill-juice added, thus completely filling the diffuser. The bottom of the latter is connected to the circulating-pump, and the juice passes from the diffuser to a liming tank (where lime-milk is added); thence, through a juice-heater, and finally returns to the top of the same diffuser, flowing downwards through the bagasse. The non-sugars, precipitated by liming and heating, are retained in the bagasse, and the filtered juice passes at once to the evaporator to be concentrated to syrup.

The bagasse remaining in the diffuser is saturated with juice, and is then subjected to the same washing-treatment as in the Geerligs-Hamakers Process, until the juice is completely washed out. The diffuser is then discharged, and the bagasse re-crushed in a second mill so that it may be used as fuel.

At Messrs. Hinton's factory a total extraction of 95% of the sucrose in the cane was obtained in 1904. At "Fortuna" Factory, Porto Rico, an extraction of 96% was obtained; with a dilution of 10% of the normal juice. At "Caroni" Factory, Trinidad, an extraction of 92.8% was obtained; with a dilution of 27.3% of the normal juice. And at "San José" Factory, Cuba, an extraction of 93.2%. These results are inferior to those obtained by the washing-processes described above, and do not compare favourably with the extraction obtained with powerful multiple-mills and heavy saturation of the bagasse during milling. But the rapid filtration of the limed juice is an important gain, since it dispenses with the cumbersome subsiding tanks, re-subsiders, and filter presses.

It must be admitted that the foregoing methods of washing the bagasse are much more efficient than any process of saturation applied during milling, but this gain is attended by the following disadvantages:—

(1) Two milling plants are required for dry-crushing the cane, and later, for re-crushing the washed bagasse. If these were combined to form one multiple mill, this would extract very nearly as much sugar by the more direct method of wet-crushing, now generally employed; and without the additional cost of the diffusion battery and skilled labour to operate it.

(2) As explained in the last chapter, a high extraction of sucrose is not necessarily a profitable extraction. Gummy impurities may be extracted from the bagasse during the washing-process; in which case some of the sugar, extracted at the same time, may be incapable of crystallising. The result would be to increase the yield of final molasses, or by-product.



PART III

EXTRACTION OF SUGAR FROM THE BEET

- CHAPTER 9. PRINCIPLES OF THE DIFFUSION PROCESS
- „ 10. APPARATUS USED FOR DIFFUSION
- „ 11. OPERATING THE DIFFUSION BATTERY, AND EFFICIENCY OF EXTRACTION



CHAPTER IX

PRINCIPLES OF THE DIFFUSION PROCESS

PRIOR to 1860, beet juice was extracted by rasping the roots and subjecting the pulp to heavy pressure, either in hydraulic presses, or between rollers, thus copying the method of extracting juice from the cane.

In 1821, Matthieu de Dombasle proposed cutting the roots into thin slices and extracting the sugar by means of hot water; a process which he termed "maceration." His apparatus resembled the "diffusion battery" employed to-day in every detail; yet did not then prove successful, because his "maceration juice" could not be clarified by the simple chemical treatment with lime, then successfully used for the juice extracted by rasping and pressing.

The problem of purifying beet diffusion-juice was solved, in 1849, by Rousseau's "*carbonation process*," which was perfected by Périer and Posséz in 1859. The main objection to Dombasle's maceration process being thus removed, it was taken up and successfully applied by Robert in 1860, under the name of "*the diffusion process*," and has been since adopted in all beet-sugar factories.

GENERAL PRINCIPLES

If water be cautiously added to the surface of a strong sugar solution, the two liquids form distinct layers; the former resting upon the latter. Diffusion can take place at the points of contact, and, after a sufficient lapse of time, the sugar becomes uniformly distributed throughout both liquids. The same blending occurs when two sugar solutions, of different densities, are brought into contact; also when solutions of many other substances are similarly treated.

. If the two liquids be separated by a sheet of parchment-paper, the same blending occurs through the separating membrane; but the rate of diffusion varies greatly when different substances are tested. Those which diffuse rapidly are crystallisable, hence termed "Crystalloids"; sugar and salt, for example. Others, which diffuse slowly, or not at all, are uncrystallisable, and termed "Colloids"; albumin, for example. If a liquid, containing both sugar and albumin in solution, be placed on one side of the membrane, and pure water on the opposite side, the sugar will pass through the membrane into the water, leaving the albumin behind. This method of separating a crystalloid from a colloid is termed *dialysis*, and the separating membrane is called the *dialyser*, or *septum*. The process differs entirely from filtration, because the substances to be separated are both in solution.

The minute cells of plants are composed of vegetable membranes, which act as dialysers. During the plant's growth, the sugar manufactured in the leaf passes into other parts of the plant by diffusing from cell to cell through the membranes or cell-walls, until each cell ultimately becomes rich in sugar. In order to extract this stored sugar, the foregoing dialysis is reversed in the following manner.

The beetroot is cut into thin slices or shreds which are immersed in hot water. The sugar then diffuses from the interior of the plant-cells until it is uniformly distributed between the exterior liquid (water) and the interior liquid (beet-juice). Any colloid substances present in the beet juice remain in the beet-cells, or diffuse much more slowly than the sugar, and the water-extract (diffusion juice) is consequently purer than the true beet juice. [In the earlier method of extraction, by rasping and pressing, the beet-cells are completely destroyed, so that their total contents (sugar + non-sugars) pass into the extracted juice. This also occurs in the extraction of cane juice by milling.]

The motion of the denser liquid through a membrane, or dialyser, is termed *endosmose*; and is accompanied by a contrary motion of the less dense liquid, termed *exosmose*. Hence, after the complete extraction of the sugar, the cells

which compose the beet-slices remain completely filled with water.

The practical application of dialysis in the extraction of sugar from the beet may be illustrated as follows. A quantity of sliced beet (containing x parts of beet juice) is immersed in x parts of water. Diffusion will proceed until the sugar is equally distributed throughout the total liquid, namely, 50% in the added water, and 50% in the slices. The former 50% can then be drawn off. The partially exhausted slices are immersed in a similar quantity of fresh water; and, after diffusion is complete, 25% of the original sugar can be drawn off, leaving 25% in the slices. As every additional treatment reduces the unextracted sugar by one-half, ten treatments will extract all but 0.098% of the sugar originally contained in the slices, and twelve treatments would leave only 0.024%.

These ten or twelve extracts, when mixed together, would form a very dilute sugar solution, requiring much evaporation to convert it into syrup. To avoid such dilution, each portion of water is added to twelve (or more) separate portions of beet slices, in separate vessels called "diffusers"; the water passing from one diffuser to another by means of connecting pipes, but the beet slices remaining stationary in each diffuser.

Fig. 13 represents a circular battery of twelve diffusers, which are filled in turn with beet slices. Water enters No. 1 under pressure, and flows in the direction indicated by the dotted line, extracting sugar from the slices contained in No. 1 and the following diffusers, until further extraction ceases owing to the increasing density and sucrose-content of the liquid when reaching No. 5, for example. At this density, it is termed *diffusion juice*. Each charge of water entering No. 1 forces the previous charge (in No. 1) into No. 2; that already in No. 2 into No. 3; and so on. The sixth charge of water entering No. 1 forces one portion of the diffusion juice out of No. 5 (see arrow in Fig. 13) by opening a valve on No. 5; and, on closing this valve, a second portion of this juice is forced from No. 5 into No. 6. Similarly, the seventh charge of water entering No. 1 forces

one portion of diffusion juice out of No. 6, and the remainder into No. 7.

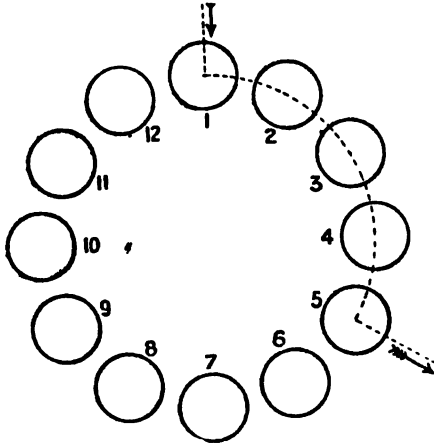

FIG. 13.—WORK STARTING

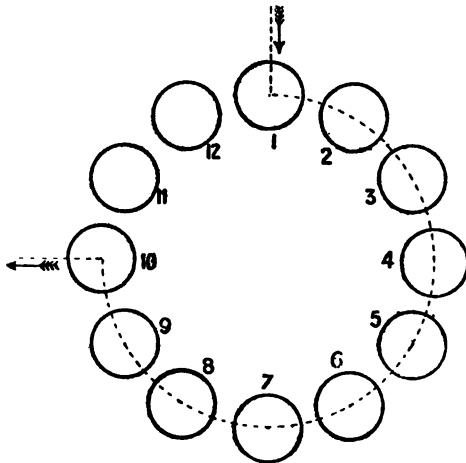

FIG. 14.—TENTH DIFFUSER FILLED

During these operations, the liquid entering any one diffuser is always of lower density than the liquid it displaces ; and, therefore, of lower density than the fluid enclosed in

the cells of the beet-slices. Consequently, every forward motion of the numerous liquids causes diffusion to continue in every diffuser simultaneously, and the liquids increase in density as they move forward from one diffuser to another.

In Fig. 14, the work has proceeded as far as No. 10. When it reaches No. 12, the slices in No. 1 have undergone twelve diffusions, and are practically free from sugar, or are "exhausted." Those in No. 2 have undergone eleven diffusions, and are nearly exhausted. The slices in the following diffusers are less and less exhausted, and in No. 12 the extraction has only just commenced.

This stage of the work is called *the first round of the battery*, and represents the starting or preliminary operations. The normal, or routine work, now begins and is conducted as follows.

No. 1 is emptied, refilled with fresh slices, disconnected from No. 2 and connected to No. 12 (by closing and opening certain valves). No. 1 now becomes the last (13th diffuser), whilst No. 2 becomes the first. Fresh water is now passed direct into No. 2 (to complete the extraction here), after which No. 2 is emptied, refilled with fresh slices, disconnected from No. 3 and connected with No. 1 (now No. 13). Hence, No. 2 now becomes the last (or 14th diffuser) whilst No. 3 becomes the first.

Consequently, after *the first round of the battery* is completed, each diffuser undergoes the following cycle of operations:—

- | | |
|---|--|
| <ul style="list-style-type: none"> (a) Filled with fresh slices from the slicing machine. (b) Diffusion juice enters and, by further diffusion, attains the desired density. (c) A measured volume of diffusion juice is displaced into measuring tank by the entrance of more dilute juice. (d) Repeatedly filled with liquids of decreasing densities. (e) Filled with pure water direct from water-main as the final washing. (f) Exhausted slices discharged, leaving diffuser empty. | } All entering liquids arrive from the previous diffuser (i.e. enter No. 6 from No. 5, or enter No. 12 from No. 11). |
|---|--|

The cycle then recommences at (a).

The diffusion juice is drawn from each diffuser, in turn, into a measuring tank, and thence to the liming tank for chemical treatment.

CHAPTER X

APPARATUS USED FOR DIFFUSION

Note.—See “Introductory Note” to Chapter VI. Numerous illustrations of the apparatus described in this chapter will be found in Ware’s *Beet Sugar Manufacture and Refining*, Vol. I, Part ii, chapters 1-3.

I. BEET SLICERS

The *Disc-Slicer* is generally used, and consists of a horizontal rotating disc, surmounted by a stationary cylindrical hopper, into which the beets are fed from an automatic elevator. The upper surface of the disc carries numerous horizontal knife-blades, arranged as radii; and the disc is pierced with slots (below each cutting edge) through which the slices fall. The beets are pressed downwards against the rotating disc and knives by the weight of the overlying beets in the tall hopper, which is kept constantly filled; such pressure also preventing the beets from being carried round on the disc. As fast as the lowermost roots, resting on the disc, are sliced, others immediately take their place.

The diameter of the disc varies from 4 to 8 feet, and the number of knives varies with this diameter. The individual knife-blades are about $5\frac{1}{2}$ inches in length, and are grouped in pairs; each pair forming one cutting edge, 11 inches in length (= one radial line on disc). A disc containing 8 pairs of knives rotates at a speed of from 100 to 150 revolutions per minute. Larger discs may carry 12 pairs of knives, and rotate at a lower speed. The knives are not permanently attached to the disc, but are fixed in frames or “holders” which fit accurately into rectangular openings in the disc, thus permitting the entire set of knives to be replaced by a

fresh set in a very few minutes. The worn knives are cleaned, sharpened, and accurately adjusted in their frames, before being placed in the machine.

In order that the slicing may be continuous, two machines are usually employed; one operating, whilst the other is being refitted. With normal beets, one machine may continue in operation for 10 hours before the knives require to be renewed; but, with inferior and fibrous roots, the knives may have to be renewed very frequently.

The Rasmus Slicer.—In this machine, the knives are stationary, and the roots in rapid motion. The knives, in their holders, are attached vertically to the periphery of a stationary cylinder with vertical axis; the cylinder being closed below by a rotating plate or cone, mounted on a vertical shaft. Above this plate, and revolving with it, are several radial wings extending to the periphery of the cylinder, and therefore closely approaching the stationary knives. The beets, entering at the open top of the cylinder, are carried round by the rotating wings and cone-shaped bottom plate, and forced into contact with the stationary knives by centrifugal force. The slices pass through apertures behind the knives into an outer casing, from which they gravitate to an inclined hopper. This type of slicer was employed for many years, but is now obsolete.

The Maguin Drum-Slicer.—This resembles the *disc-slicer*, the beets being stationary, and the knives rotating, but the mechanical arrangement is entirely different. The knives, in their holders, are attached to the periphery of a horizontal rotating drum; all the knife-edges being parallel to the axis of the drum, and to each other. The roots enter the drum through a hopper at one end, and the rotary motion forces the roots against an internal, stationary casting, which gradually approaches the periphery of the drum, forming a curved and wedge-shaped channel between the two. The roots become wedged in this channel and are thus forced into contact with the moving knives; the slices, passing through apertures behind the knives, fall into a hopper below.

The drum carries 8 knife-holders, each containing

6 knives in pairs; thus forming 24 parallel cutting-edges. As a single knife is 165 mm. in length, the total cutting-edge of the machine = $165 \times 48 = 7920$ mm. (= 26 feet). At 60 revolutions per minute, it can slice 20 tons of roots per hour, and consumes 50% less power than the machines described above.

The modern beet-knife of the slicer was developed from two earlier types, which may be very briefly described.

The *Neprawil* knife was the earliest, and had a straight cutting-edge. The *Goller and Koenigsfeld* blade had a fluted cutting-edge, and yielded slices having a V-shaped cross-section. This prevents the slices from packing too closely in the diffusers, and thereby hindering the free circulation of the diffusion liquids. The modern *Ridge blade*, designed by Egerle, is a combination of the two earlier types, and also produces slices having a V-shaped cross-section. Each ridge on this knife encloses an angle of 60°. A more acute angle would be preferable, but the knives are then more liable to become clogged with fibrous matter.

2. DIFFUSERS

These are cylindrical vessels, of from 50 to 100 hectolitres capacity; the upper and lower portions being usually conical, and terminating in two doors (Fig. 15). The slices enter through the smaller door, at top; and, when diffusion is complete, they are discharged through the larger door, at bottom. The slices are supported below by a lining of perforated metal in the conical portion of the diffuser, and a flat perforated plate, permanently attached to the discharge-door. The whole perforated area acts as a strainer, preventing the slices from passing into the pipe through which the diffusion juices pass from the bottom of each diffuser to the top of the following diffuser. To ensure rapid discharge, the bottom opening and its door may be of the same diameter as the vessel itself.

A battery of diffusers may be arranged, either in a circle, or in parallel lines. Fig. 15 represents a general view of a circular battery. The slicing machine is placed in a central position over the battery; and, attached to it, is a rotating

hopper, which moves round the battery and thus fills each diffuser, in turn, with slices. After diffusion is complete, each diffuser is discharged into a central pit, from which the

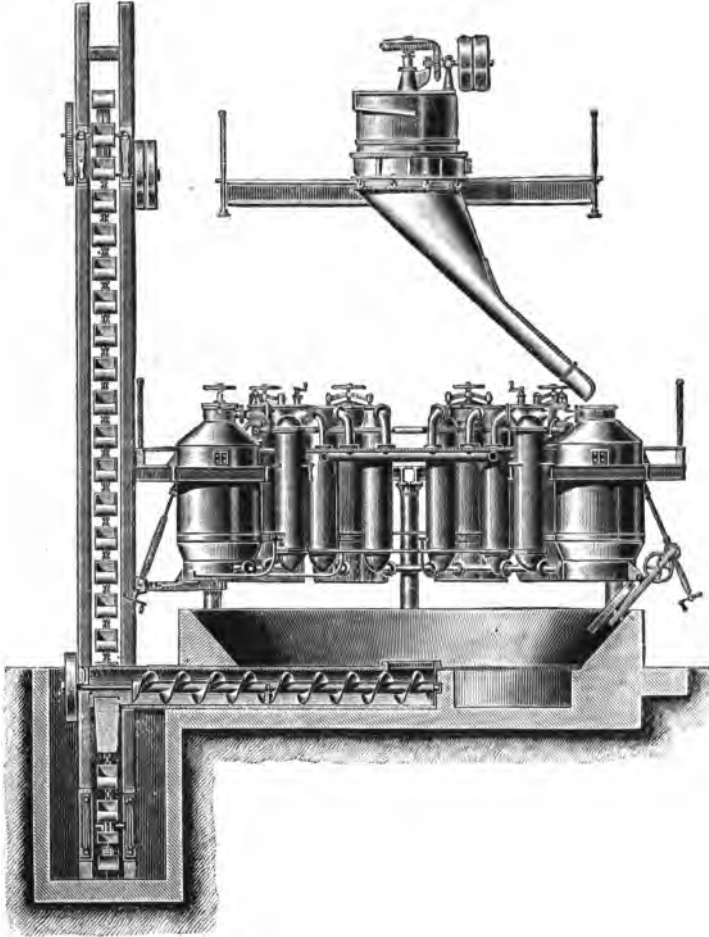

FIG. 15.—SECTIONAL VIEW OF CIRCULAR DIFFUSION BATTERY

exhausted slices are removed by a screw-conveyor, transferred to a bucket-elevator (shown on the left), and discharged into the pulp-presses.

The double-line battery is the more general arrangement,

because it occupies less floor-space than the circular battery, and additional diffusers can be added to each line, without disturbing the others. The slicing machine is placed above one extremity of the double-line, and the slices are transported to the diffusers by one of the following methods :—

(a) A horizontal band-carrier, moving centrally over the double-line, with arrangements for deflecting the moving slices into hoppers over each diffuser.

(b) The slices fall into two trucks, or travelling-hoppers, which run above each line of diffusers, and can be discharged into any one. The travelling-hopper may be of such capacity as to fill one diffuser at each operation ; or, two or three loads are required from a smaller hopper.

After diffusion is complete, the exhausted slices are discharged, and removed from the battery by one of the following methods :—

- (1) The slices fall upon two travelling bands, or transporters ; one under each line of diffusers.
- (2) Or, into two sloping concrete flumes ; one under each line of diffusers. The water, discharged along with the slices, carries them along the flume to a well at the deeper end. Or, a stream of water may enter the flume at the opposite end.
- (3) Or, into a channel containing a rotating spiral transporter, which moves the slices towards a well at one end.

From the receiving well (in methods (2) and (3)), the slices are elevated, by a mechanical transporter, to the Pulp Presses, to be described later.

Whether the diffusers be arranged in a circle, or in double-lines, the number of diffusers must be such that two are always out of action ; namely, one discharging, and one being refilled with fresh slices. Generally, an additional or "spare" diffuser is provided, but only used in certain emergencies.

3. HEATERS OR "CALORIZATORS"

As diffusion is more rapid at high temperatures, the diffusion juices are heated as they pass from one diffuser

to the next. The earliest and simplest method is to inject live-steam into the connecting pipes, and is still advocated on account of its cheapness; the best form of injector being the Blancke and Koerting, which acts noiselessly. The more usual arrangement is to employ tubular heaters, or "calorizators," in which the juice flows through numerous tubes heated externally by steam, this steam being confined within an external jacket or cylinder. The number of heating tubes depends upon the size of the diffuser to which the calorizator is attached, also on the temperature of the steam used for this purpose. The usual proportion is 0·1 square metre of heating surface per hectolitre capacity of diffuser.

4. PIPE CONNECTIONS

One calorizator is introduced between the bottom of each diffuser and the top of the following diffuser, thus forming a connecting-pipe, by which the diffusion liquids move from end to end of the battery (Figs. 16 and 17). Other pipe connections are required for the following purposes:—

- (a) To admit fresh water to the top of each diffuser.
- (b) To admit compressed air to the top of each diffuser.
- (c) To draw off diffusion juice from each diffuser and convey same to the measuring tank.
- (d) To supply steam to the numerous calorizators, and to carry away condensed steam.

These pipes run horizontally, close to the diffusers, and carry short branch-pipes with valves, leading to each diffuser. When the battery is circular, these pipes form an inner circle, and the battery-operator, standing in the centre, has all the valves close to his hand. The valves are so constructed that he can see at a glance which are open, and which closed. To avoid mistakes, the valves are sometimes painted different colours; such as red for water, white for juice, green for compressed air, etc.

5. MEASURING TANK.

This is situated near the battery, and receives the diffusion juice by means of the pipe (c) mentioned above. The object

is to draw off a *measured volume* of juice from each diffuser in turn ; such volume depending on the degree of extraction desired (as will be explained in the following chapter). The juice, after being measured, passes into the factory to be purified and evaporated to syrup.

The measurement is usually effected automatically by means of a float rising within the tank, as the latter fills, and ringing an electric bell when the liquid reaches a certain level. The man in charge of the battery then closes the valve on the diffuser from which the juice was passing to the tank. Or, the tank may be fitted with an adjustable overflow-pipe, causing the excess of juice to flow back into the battery, leaving the required volume in the tank, which is then discharged.

As the juice is drawn off at short intervals, from only one diffuser at a time, a single measuring tank is sufficient, provided that it can be emptied rapidly. For this purpose, the sectional area of the discharge-pipe should be double that of the inlet, or supply-pipe. In some factories, two measuring tanks are used, one filling whilst the other is discharging.

6. PULP PRESSES

When discharged from the battery, the slices contain about 95% of water, and their weight is about equal to that of the slices before diffusion ; beet juice having been replaced by water. As this wet material is of no value as fodder, the factory equipment must include pulp-presses in order to work profitably.

(a) *The Skoda Rulp-press and Elevator* consists of an Archimedian screw rotating within a cylinder of perforated sheet metal, surrounded by an exterior metal casing. The apparatus can be fixed at any suitable angle, so as to elevate the slices, press them, and discharge the pressed slices into small trucks. The lower portion of the apparatus is cylindrical, but the upper portion is tapered, so that the channel through which the slices move becomes gradually restricted, applying a gradually increasing pressure. The extracted water passes through the perforated walls of the channel into the exterior casing ; whence it flows back to the lower level.

(b) *The Klusemann Press* is the one generally employed, and applies a gradually increasing pressure to the slices by a slightly different arrangement from the last. A hollow, vertical cone of perforated metal rotates slowly within a rigid cylinder, also of perforated metal. The wet slices enter through a hopper at the top of the cylinder, and are forced downwards between the cylinder and central cone, by means of blades projecting horizontally from the cone, and arranged spirally thereon. As the volume of the slices becomes reduced, water escapes into the interior of the perforated cone, and also through the perforations in the cylinder, and runs off through outlet-pipes below. The cone makes from 3 to 5 revolutions per minute, this motion being obtained by a belt-pulley and gearing. One press can treat 50 tons of slices in 24 hours, and consumes only $1\frac{1}{2}$ H.P.

(c) *Selwig and Lange Press*.—In this type, also, the slices pass through a wedge-shaped channel between two perforated surfaces, but both surfaces are flat, and move in the same direction as the slices. The apparatus consists of two perforated metal discs of equal size, rotating opposite each other at the same slow speed, but on separate shafts. The shafts are slightly inclined from the horizontal, but in opposite directions, so that the rotating discs are not parallel, but approach each other below their centres of rotation.

The wet slices enter by a hopper, above the two discs, filling the space between them; and, as the discs move through a half-revolution, they approach each other, thus applying an increasing pressure. Further rotation causes the discs to separate, and the pressed slices are forced out by means of a scraping device, after the discs have made three-quarters of a revolution. The pressure applied can be varied by means of set-screws, which alter the inclination of the discs. The water passing through the perforated discs, escapes from a discharge-pipe below.

From 100 kilos. of wet slices, entering the press, 47 kilos. of pressed pulp, and 53 kilos. of "sweet-water" are obtained. The pressed pulp therefore represents about 50% by weight of the original beets treated. Excessive pressure produces a

pasty material, which is difficult to handle; and also forces the pulp into the perforations, so that small particles are carried away by the "sweet-water." The presses are usually placed on an upper floor of the factory, and the pressed pulp gravitates to a pulp-storage bin below; and again gravitates through hoppers into waggons, carts, or barges, in which it is transported from the factory.

Certain improvements in diffusion apparatus are described in the following chapter (p. 99).

CHAPTER XI

OPERATING THE DIFFUSION BATTERY, AND EFFICIENCY OF EXTRACTION

THE general mode of operating having been described in Chapter IX, certain details now claim attention; and the following definitions are necessary:—

“Head-diffuser” = that in which extraction is just commencing.

“Tail-diffuser” = that in which extraction is nearly complete.

“Active diffusers” = the number in operation at one time.

At any given moment, the diffusion liquids move from the tail-diffuser in the direction of the head-diffuser; and it will be assumed that the battery contains twelve active diffusers, also one filling, and one discharging.

CIRCULATION OF LIQUIDS IN THE BATTERY

Adding Water to Tail-diffuser.—In Fig. 16, the water inlet to diffuser No. 1 is shown in section at W_1 . The valves B_1 , C_1 , and C_2 are closed; W_1 and B_2 are open. Water then enters by displacing the very dilute diffusion juice (previously present) through calorizator A_2 , and valve B_2 , into the top of diffuser No. 2. Here, a similar displacement is caused, forcing the previously contained liquid through the calorizator A_3 , and valve B_3 , into the top of diffuser No. 3; and so on.

Normal Circulation is now taking place in No. 2 (as indicated by the arrows), and is repeated in all the following diffusers up to the head-diffuser No. 12, in which the liquid (entering from No. 11) has attained the density of diffusion juice.

Drawing off Diffusion Juice from Head-diffuser.—In Fig. 17, the valves B_{12} , C_{13} , and E_{12} are opened; B_{13} and C_{12} being closed. The more dilute juice, entering at B_{12} (from diffuser

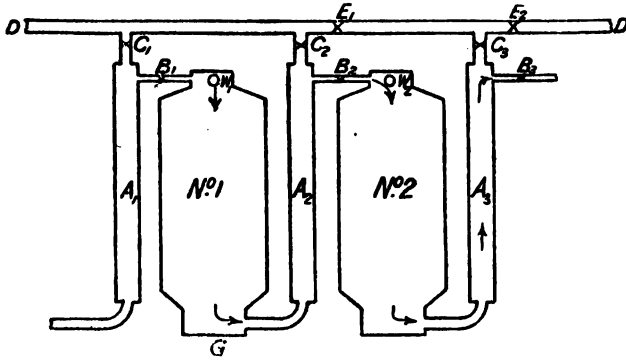

FIG. 16.—WATER ENTERING TAIL-DIFFUSER NO. 1, AND NORMAL CIRCULATION IN NO. 2]

No. 11), displaces the denser juice in No. 12, which ascends through calorizator A_{13} and valve C_{13} into juice-pipe DD ; whence it passes through valve E_{12} to the measuring tank.

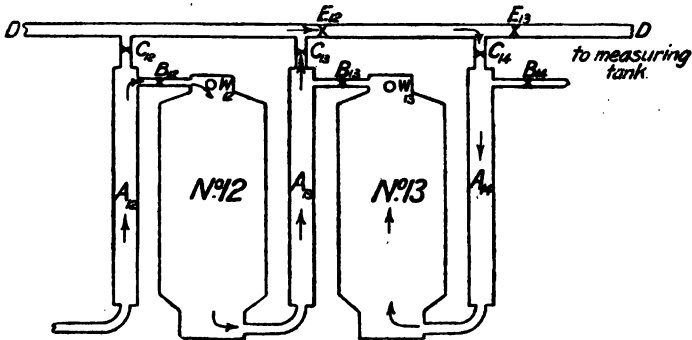

FIG. 17.—DRAWING OFF DIFFUSION JUICE FROM NO. 12, AND FILLING NO. 13

The balance left in No. 12, plus the juice just entering from No. 11, is required to fill No. 13, as follows. (This No. 13 is merely the *next* diffuser to No. 12; that is, one of the two inactive diffusers, now coming into action.)

Filling Diffuser No. 13.—This has just been charged with

fresh slices. The valves C_{13} , C_{14} , and E_{12} are opened; valves B_{13} , B_{14} , and E_{13} being closed. Juice from No. 12, then enters No. 13 by the following route:— A_{13} , C_{13} , D , C_{14} , and A_{14} ; thus entering from below in order to displace the air, which escapes through a small cock F (in top-door), which is closed as soon as juice begins to escape. By contact with the fresh slices the juice attains the desired density, so that No. 13 becomes the head-diffuser, instead of No. 12. The valves are then adjusted for drawing off a measured volume of juice, as in the case of No. 12.

Discharging the Tail-diffuser.—Returning to the tail-diffuser, No. 1 (Fig. 16), the exhausted slices are discharged by opening the bottom-door, G . But, generally, as much water as possible is first forced from this diffuser into No. 2 by admitting compressed air by another inlet pipe (close to W_1).

EFFICIENCY, OR DEGREE OF EXTRACTION

(1) *Influenced by the Number of Diffusers.*—The extraction is directly proportional to the number of "active" diffusers, when the liquids move through the battery at a uniform speed. Consequently, in order to obtain the same degree of extraction, in a short, as in a long battery, the former must either have taller diffusers (equivalent to two, one above the other), or the liquids must move more slowly through the shorter battery, so as to increase the period of contact with the slices.

(2) *Influenced by the Volume of Water entering the Battery.*—If the extraction were perfect, the quantity of sugar (in the form of juice), drawn off from each diffuser, would be equal to the quantity of sugar (in the form of fresh slices) entering each diffuser; and the volume of water added to each tail-diffuser, would be exactly equal to the volume of juice drawn off from each head-diffuser. As extraction is never complete, the volume of water added varies in different factories; the chief factors being:—

- (a) The cost of fuel (coal) required to evaporate the added water, so that the sugar may be converted into crystals.

- (b) The cost of labour required to convert this extracted sugar into crystals.
- (c) The cost of the beets delivered at the factory.
- (d) The market price of sugar.

The problem therefore resembles that of the profitable limit of extracting juice from the sugar-cane by milling and maceration (see Chapter VII). The degree of extraction by diffusion is directly proportional to the volume of water added per diffuser; or, more exactly, per 100 kilos. of sliced beet entering the diffuser.

In many factories, the practical limit is reached when the discharged slices contain 0·1% of sugar by weight; but, in other factories, the limit is 0·4%. Satisfactory work gives 0·3% in the slices, and 0·2% in the discharged water (called "sweet-water"); or a total of 0·5%.

A rational limit has been proposed, based on the composition of the very dilute diffusion juice in the tail-diffuser, since this juice has the lowest purity in the whole battery. Its purity should not be lower than 60 (*i.e.* that of beet-molasses), otherwise the extracted sugar merely forms molasses, after evaporation of the water.

It is always profitable to employ more water when treating beets rich in sugar than when treating inferior roots; thereby exhausting the slices to a uniform limit. The quantity of water added per 100 kilos. of sliced beet should therefore be proportional to the sugar-content of the beets treated (the same applies to the quantity of maceration water applied during milling of the sugar-cane). In both methods of extraction, the quantity of added water may be regulated by observing the density of the extracted (diluted) juice; but, as this simple test is not always reliable in the case of diffusion, it is preferable to be guided by the percentage of sucrose remaining in the discharged slices.

(3) *Influenced by the Quality of the Slices entering the Battery.*—In practical diffusion, three independent actions proceed, side by side:—

- (a) *True diffusion*, or dialysis, in those portions of the slices containing unbroken cells.

- (b) *Maceration*, or washing, in those cells which have been cut open or broken by the slicing-knives. The contents of such broken cells (sucrose + non-sugars) pass into the diffusion liquids.
- (c) *Partial solution* of the solid matter (marc) of the beet, if the diffusion liquids have too high a temperature.

The rate of true diffusion (*a*) is increased by the following factors:—

- (1) The thinness of the slices, thus increasing the area of contact between the beet cells and the diffusion liquids.
- (2) The difference in density between the beet-juice, enclosed in the beet-cells, and the exterior diffusion liquids.
- (3) The temperature during diffusion.
- (4) The circulation of the exterior diffusion liquids through the mass of beet slices in the diffuser.

The first factor is limited by the mechanical difficulty of slicing the roots beyond a certain degree of fineness; so that all conclusions regarding practical diffusion must be based on slices of medium thickness. Further, it will be evident that the more finely the beets are sliced, the larger will be the percentage of cells cut open by the knives (see (*b*) above).

Factor (2) indicates that diffusion diminishes and finally ceases when the interior and exterior liquids contain the same percentage of sugar.

Factor (3) is limited by the fact that the solid matter of the slices softens, swells, and becomes partially soluble in water, at a temperature of 83°C.; thus causing non-sugar to pass into the diffusion juice.

Factor (4) depends on the form of the slices, due to the form of the knives (as explained in the last chapter).

The quality of the beets treated may cause difficulties in slicing, and thus seriously interfere with the subsequent extraction. When treating frozen beets, the slices may freeze together, forming compact lumps, which do not

completely thaw during diffusion ; or, after thawing, become soft and pulpy, thus hindering the circulation of the liquids.

(4) *Influenced by the Velocity of the Liquids circulating in the Battery.*—Szyfer's investigations indicate that the efficiency of extraction is proportional to:—

- (a) The velocity of the liquids passing through the battery.
- (b) The total length of the column of liquid in motion.

The former depends on the diameter of the diffusers. The latter is found by multiplying the height of one diffuser by number of active diffusers, thus giving the "total height of battery."

From numerous observations, Szyfer draws the following conclusions:—

- (a) The best results are obtained with at least 12 diffusers, of large diameter.
- (b) The most suitable dimensions of the diffusers gives the ratio $\frac{\text{Height}}{\text{Diameter}} = 1.5$.
- (c) The velocity of juices through the battery should be 18 cm. per minute (\approx 7 inches per minute).
- (d) In tall diffusers, the slices offer more resistance to the flow of liquid. And, in narrow diffusers (relative to height) the motion of the liquid is retarded by the smaller perforated area at bottom of each diffuser.
- (e) When very thin slices are treated, diffusers of large diameter are preferable ; but, with coarse slices, tall diffusers give the best results.

PURITY¹ OF THE DIFFUSION JUICE

The juice extracted by diffusion is always purer than the juice extracted by pressure, as explained in Chapter IX.

(1) *Influenced by Temperature in the Battery.*—A low temperature, and short period of contact between slices and liquids, favours the extraction of sucrose in preference to non-sugars ; and therefore yields the purest juice. Some

¹ See p. 147.

experts recommend "cold diffusion," with a maximum temperature of $62^{\circ}\text{C}.$; but this necessitates a greater proportion of water per 100 parts of beets to obtain a satisfactory high extraction.

Recent experiments indicate that a maximum temperature of 70° – $75^{\circ}\text{C}.$ is desirable to avoid excessive dilution, and to ensure good extraction; leaving 0.3% to 0.5% of sugar in the discharged slices. At temperatures above $83^{\circ}\text{C}.$, the solid beet-pulp softens, and becomes partially soluble, thus adding non-sugars to the extracted juice.

To obtain a high extraction, combined with purity of juice, the maximum temperature should exist at the "head" of the battery, gradually diminishing towards the "tail." In this manner, heat is applied only where diffusion should be most rapid, and destroys the protoplasm contained in the beet cells, thus increasing the dialysing-power of the cell-walls. But, as the slices in the head of the battery are cold (and sometimes frozen), the entering liquids are rapidly cooled, and much steam is consumed in the head-calorizers before the slices + liquid are heated up to 70° or $75^{\circ}\text{C}.$ A high temperature at the "tail" of the battery does not assist dialysis, and has the disadvantage that a larger proportion of non-sugars is extracted, and the discharged slices represent a loss of heat, and are difficult to handle.

The temperature during diffusion largely depends on the size and number of diffusers forming the battery, and the following general rules are given by Claassen:—

- (1) In a battery of 10 to 12 active diffusers, of small size (20 to 30 H.L. capacity), the temperature should be high from "head" to "tail"; the juices should circulate rapidly; and the period of contact between slices and liquids should be 60 to 75 minutes.
- (2) In a battery of 10 to 12 active diffusers, of large size (50 to 80 H.L. capacity), the maximum temperature should be at the "head," gradually diminishing towards the "tail," into which warm water is passed. The circulation should be slower than in

- (1), and the period of contact from 90 to 105 minutes.
- (3) In a battery of 6 to 8 active diffusers, of large size (50 to 80 H.L. capacity), the temperature should be high from "head" to "tail," hot water entering the tail-diffuser. The circulation should be slower than in (2); the volume of juice drawn off per 100 kilos. of slices should be larger than in (2); and the period of contact from 75 to 90 minutes.

In the above cases of "hot diffusion" (1) and (3), the water entering the tail-diffuser has a maximum temperature of 80° C.; in case (2), a maximum temperature of 50° C.; and, in the so-called "cold diffusion," the water is unheated. Claassen states that the maximum temperature in the calorizers may be from 80°–84° C., when treating healthy beets, because the temperature falls a few degrees when the liquid comes into contact with the slices in the following diffuser.

(2) *Influence of the Volume of Juice drawn off.*—The highest purity is obtained when the quantity of water entering the battery, per 100 kilos. of slices, is small. Hence, the purity of the juice increases as the degree of extraction diminishes (this being also the case in the extraction of sugar from the cane by milling). But, since the subsequent chemical treatment of the juice removes many impurities, the diffusion is largely controlled by the degree of extraction obtained. The purity of the juice is, however, a useful guide; especially when treating inferior roots.

(3) *Influence of the Fineness of the Slices.*—The finer the beets are sliced (or, the larger the number of slices per unit weight of beet), the larger will be the percentage of cells cut open by the slicing-knives, thus causing impurities to pass into the diffusion juice.

DENSITY OF THE DIFFUSION JUICE

(1) *Influenced by Cost of Fuel.*—The further the extraction is carried, the more steam (and coal) will be consumed in evaporating the added water. The foregoing considerations

regarding the limit of extraction, and purity of extracted juice, also determine the limit of dilution of the juice passing out of the battery.

(2) *Influenced by the Packing of the Slices in the Diffusers.*—Theoretically, a high density of the juice, combined with a high extraction of sugar, results when the diffusion liquids are uniformly distributed throughout the slices. This condition is obtained by a uniform packing of the slices in the diffuser, leaving only sufficient interstitial-space for the circulating liquids. Close packing is easier in the case of large diffusers, where a volume of 1 H.L. may contain as much as 55 to 60 kilos. of slices. In small diffusers, the same unit volume may contain only from 45 to 50 kilos. of slices. The internal dimensions of the piping and calorizators also influence the result.

(3) *Influence of the Volume of Juice drawn off.*—When a unit volume of diffuser-capacity contains different weights of slices (as indicated above), the volume of juice drawn off must be modified in order to obtain diffusion juice of a certain concentration, as shown below :—

	Kilos. of Slices per H.L. Capacity.	Litres drawn off per Diffuser.
Filled by gravity (without packing) .	45	158
With slight packing	50	131
„ medium packing	55	108
„ close packing	60	89

} to obtain juice of
20% dilution

The volume drawn off generally lies within the limits of 100 to 130 litres, according to the degree of extraction desired. The density of the juice varies from $\frac{3}{4}$ to $\frac{8}{10}$ of that of undiluted beet juice, as extracted by pressure.

CAPACITY, OR QUANTITY OF BEETS TREATED
PER 24 HOURS

(1) *Influenced by the Arrangement of the Diffusers.*—Two general methods of working are employed; namely—the Single or Continuous Battery, and the Divided Battery. *Single Battery work* has been described in the foregoing

pages. In the *Divided Battery*, the total number of diffusers say 14, is divided into two batteries, of 7 diffusers each. These two systems are further distinguished by the rate of operating, as follows:—

Single Battery, with slow diffusion at low temperature.— Cold water enters the tail-diffuser, the temperature rising in the following diffusers to 75°–80° C. half-way round the battery; then gradually diminishing to 28°–32° C. in the head-diffuser. Each diffuser remains in action for 85 to 90 minutes. A battery of 12 diffusers (of 25 H.L. capacity) treats 220 tons of beet in 24 hours; one of 14 diffusers treats 270 tons; and one of 16 diffusers treats 320 tons.

Divided Battery, with rapid diffusion at high temperature.— The total number of diffusers is divided into two sub-batteries of 7, 8, 9, or 11 diffusers each. Only one diffuser is out of action at a time, and the two batteries are operated alternately by the same workmen, the slices being closely packed in the diffusers. Hot water (35°–50° C.) enters the tail-diffuser, the temperature being raised in the following diffusers to 75°–80° C. as rapidly as possible, and this is maintained up to the head-diffuser. Each diffuser remains in action for from 60 to 70 minutes, and the two batteries (of 7 diffusers each) treat from 400 to 600 tons of beet per 24 hours. If the number of diffusers in each battery be increased, the working period of each diffuser can be further reduced; thus increasing the quantity of beets treated per 24 hours.

Divided Battery, with slow diffusion at low temperature.— This mode of working is only adopted when treating beets of inferior quality, the special object being to increase the period of contact between the slices and the diffusion liquid. The two batteries are worked alternately, by the same workmen; but, during the same interval of time, the liquid in each diffuser is displaced only once, where two displacements would occur in the single or continuous battery; the period of diffusion, per 100 kilos. of beets, remaining the same in the two cases.

IMPROVEMENTS IN DIFFUSION APPARATUS

(1) *Automatic Discharging of Diffusers.*—The emptying of the exhausted slices from the diffusers by gravity is simple and satisfactory, but the mechanical transport of the wet slices, from below the diffusers to the pulp-presses, is unsatisfactory and dirty. To obviate this, Pfeiffer connects the bottom discharge-opening of each diffuser to a wide-bore pipe, extending horizontally from end to end of the battery, and fitted with special valves opening into each diffuser. When a diffuser is to be discharged, this bottom valve is opened, and compressed air is admitted to the top of the diffuser. The slices are thus forced downwards into the wide-bore pipe, and enter a receiving tank which feeds the pulp-presses. This tank, and the pulp-presses, may be placed at a higher level than the diffusion battery, thus utilising compressed air for (a) discharging the diffusers; (b) transporting the slices from the battery; and (c) elevating same to an upper floor. The ground-floor, immediately below the battery, is thus kept clean, and is available for other purposes. The Pfeiffer apparatus transports 2700 kilos. of slices from a battery, and elevates them to a height of 13 metres in 25 seconds, under a pressure of $2\frac{1}{4}$ atmospheres.

(2) *Forced Circulation through the Head-diffuser.*—Referring to Fig. 17, diffuser No. 13 is filled with juice from below upwards; and, soon afterwards, the juice is drawn off in the opposite direction (shown in diffuser No. 12). Hence, the juice in the lower part of No. 13 enters last, and leaves first, and has insufficient contact with the slices. Again, the fresh slices in No. 13 are at air temperature, and rapidly cool the juice entering from No. 12, even though heated in its passage through calorizator A_{14} . This causes different temperatures at different levels in No. 13. These defects are remedied by Naudet's System of "Diffusion by Forced Circulation."

Diffuser No. 13 having been charged with slices and filled with juice, the valves C_{13} and C_{14} are closed, and an

additional pair of valves N_{13} N_{14} (corresponding to B_{13} B_{14}) are opened, thereby bringing No. 13 into connection with a small centrifugal-pump and a juice-heater. This pump draws juice from N_{14} , heats it, and returns it to N_{13} ; the same juice passing repeatedly through the same diffuser and juice-heater until the entire contents (slices + liquid) are of uniform high temperature. The pump-circuit is then disconnected from No. 13, and the hot diffusion juice drawn off, as described for No. 12.

The following figures refer to a factory having two batteries of 11 diffusers each.

	Without Naudet Circulation.	With Naudet Circulation.
Tons of beet treated per 24 hours	650 to 700	785
Litres of juice drawn off per 100 kilos. of beet .	115 to 120	103 to 104
Sucrose left in discharged slices, per 100 kilos. of beet }	0.28 to 0.35	0.28 to 0.35

Thus, the same high extraction was obtained by the Naudet System, with less water entering battery, and with more rapid working.

Other inventors have employed forced circulation, on similar lines.

(3) *Continuous Diffusion*.—The only apparatus of this type which has been in actual use was designed by Charles and Perret. It consists of a closed horizontal cylinder, 8 metres long, and 1 metre in diameter, fitted with a slowly rotating spiral on a central shaft. The beet slices enter through a hopper at one extremity of the cylinder, and are slowly moved forward to the opposite extremity by the revolving spiral, hot water being forced through the cylinder in the opposite direction. The rate of motion of the slices and water is so adjusted that the slices contain about 0.5% sugar when reaching the discharge, or “tail end” of the apparatus. Here, the slices fall upon a travelling band, which conveys them to the pulp presses.

Continuous diffusers have also been designed by Bertram, and by Kessler. In both of these, the same “counter-current

principle" is adopted, but the apparatus is more complicated. A large part of the water is extracted from the exhausted slices during their passage through cone-shaped perforated cylinders at the "tail end" of the batteries, thus reducing the subsequent work in the pulp-presses.

NO. 1000
APPROVED

PART IV

COMPOSITION OF CANE AND BEET JUICES

- CHAPTER 12. INTRODUCTION—PROPERTIES OF THE SUGARS
- ” 13. COMPOSITION OF THE CANE, AND EXTRACTED JUICE
- ” 14. COMPOSITION OF THE BEET, AND EXTRACTED JUICE
- ” 15. INFORMATION OBTAINED BY ANALYSIS

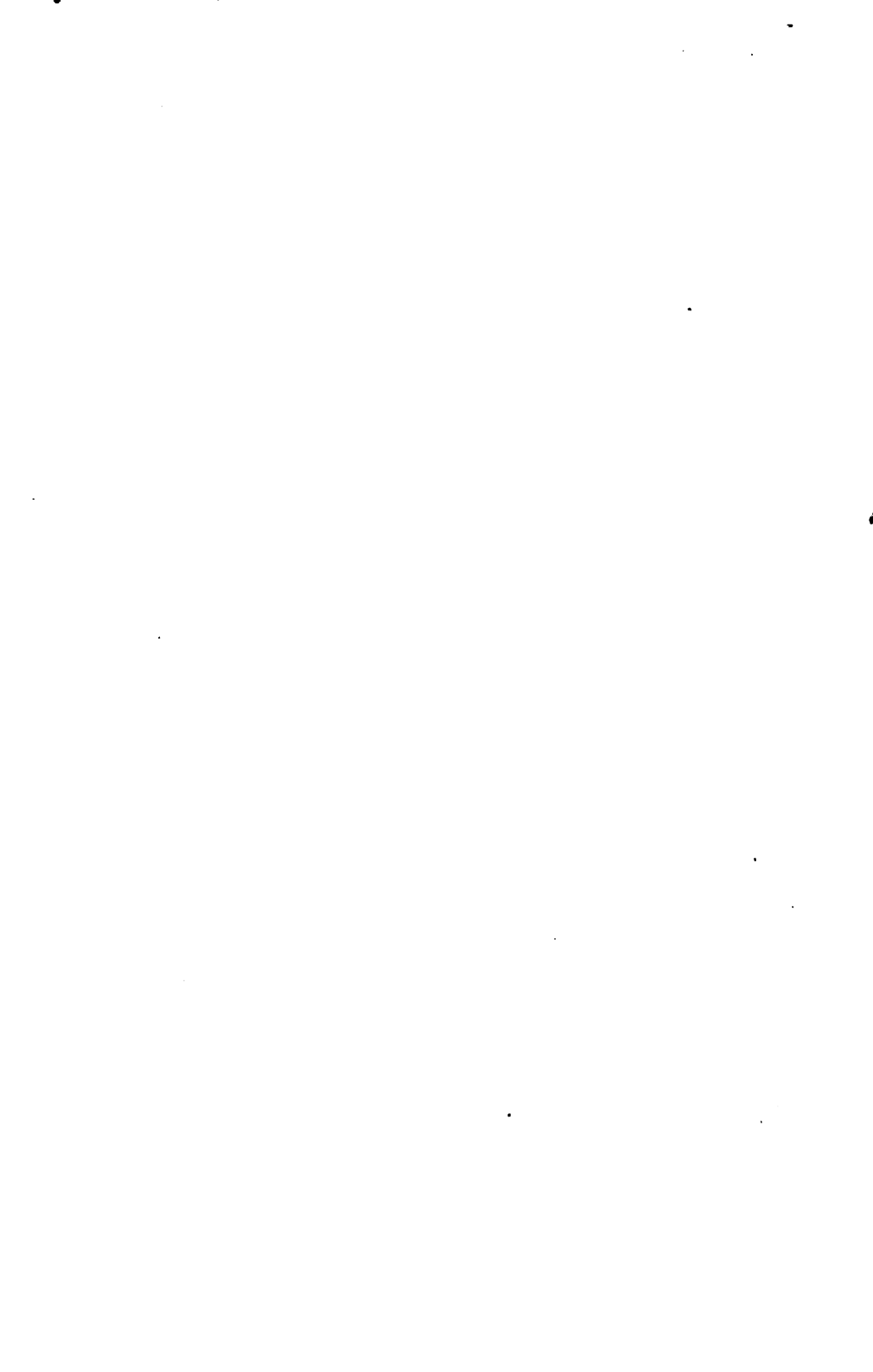

CHAPTER XII

INTRODUCTION—PROPERTIES OF THE SUGARS

THE group of carbohydrates, called Sugars, is classified as follows:—

(a) Monosaccharides (or simple sugars)	}	Dioses $C_2H_4O_2$ Trioses $C_3H_6O_3$ Tetroses $C_4H_8O_4$ Pentoses $C_5H_{10}O_5$ Hexoses $C_6H_{12}O_6$ Heptoses $C_7H_{14}O_7$ Octoses $C_8H_{16}O_8$ Nonoses $C_9H_{18}O_9$	= glucose, fructose, galactose, mannose, etc.
(b) Disaccharides		$C_{12}H_{22}O_{11}$	= sucrose, lactose, maltose.
(c) Trisaccharides		$C_{18}H_{32}O_{16}$	= raffinose, melicitose.
(d) Tetrasaccharides		$C_{24}H_{42}O_{21}$	= stachiose.

The monosaccharides are defined as first oxidation products of alcohols which contain more than one atom of carbon, to each of which is attached an hydroxyl-group. According to the number of carbon atoms in the molecule, monosaccharides are termed dioses, trioses, etc. A very large number of these do not occur in Nature, but can be prepared synthetically.

The compound sugars, (b) (c) and (d), may be regarded as formed by the union of two or more hexose sugars, by abstracting one or more molecules of water, thus:—

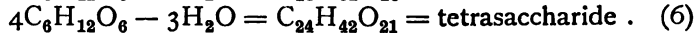
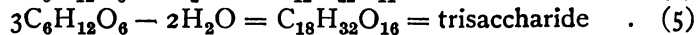

The present work relates to only one of these numerous sugars, namely Sucrose, which is extracted from various plants; but the sugar-cane also contains small percentages of two hexose sugars—fructose and glucose; and the beet contains a small percentage of the trisaccharide raffinose.

The properties of these four sugars form the subject of the present chapter.

I. SUCROSE, OR SACCHAROSE, $C_{12}H_{22}O_{11}$

(a) *Physical Properties*

(1) *Crystalline Form* (see Chapter XXII, p. 276).

(2) *Solubility*.—Sucrose is very soluble in cold water and in dilute alcohol, and slightly soluble in pure alcohol at boiling point. It is insoluble in chloroform, ether, and glycerine. The solubility in water increases with rise in temperature, and may be represented by a curve. A saturated solution at $0^{\circ} C.$, contains 64.18% sucrose by weight; and a saturated solution at $100^{\circ} C.$, contains 82.97%. Or, 100 parts of water dissolve 179.2 parts of sucrose at $0^{\circ} C.$, and 487.2 parts at $100^{\circ} C.$ At average temperatures, one part of water dissolves about two parts of sucrose.

(3) *Specific Gravities of Sucrose Solutions*, containing various percentages of dissolved sucrose, are given in published Tables. In the sugar factory, the density is usually measured by means of the "Brix-" or "Balling-Saccharometer," a form of hydrometer graduated in percentages of sugar by weight. The specific gravities, corresponding to the observed "degrees Brix," are then found by reference to published Tables.

(4) *Refractive Indices of Sucrose Solutions*.—When a ray of light passes obliquely from air into water (or a solution of sucrose), the path of the ray is bent, or refracted. The ratio between the sine of the angle of the incident ray (in air), and the sine of the angle of the refracted ray (in the liquid tested), is constant for that particular liquid, and is called the "refractive index." Thus, the ratio of $\frac{\text{water}}{\text{air}} = \frac{4}{3} = 1.333$ at $20^{\circ} C.$

The refractive indices of solutions containing various percentages of sucrose have been determined, and are recorded in published Tables; a few values are given in Table I (p. 109). The measurement is made by means of the refractometer.

(5) *Optical Rotation*.—Solutions of sucrose (and other sugars) rotate a ray of plane-polarised light, and the degree

of rotation is measured in the polariscope,¹ or saccharimeter.¹ The relative rotations caused by different sugars (or "Specific Rotatory Powers") are determined as follows:—

- (a) *Measurement.*—Ten grams of pure sucrose are dissolved in water, and the solution diluted to 100 c.c. A column of this solution, 1 decimetre in length, placed between the nicol-prisms of the polariscope, causes a rotation of 6·65 degrees on the graduated arc, at a temperature of 20° C.
- (b) *Calculation.*—"Specific Rotatory Power" is defined as the angle of rotation which plane-polarised light undergoes on passing through 1 decimetre of solution, containing 100 grams of the substance in 100 c.c., at a temperature of 20° C.; the wavelength of the light employed being that of the sodium-line D.

The actual measurement (a) = 6·65 degrees for 10 grams sucrose in 100 c.c.

∴ Specific Rotatory Power = 66·5 degrees for 100 grams sucrose in 100 c.c.

A second test gave = 33·14 degrees for 50 grams sucrose in 100 c.c.

∴ Specific Rotatory Power = 66·28 degrees for 100 grams sucrose in 100 c.c.

It will be seen that the two tests, when calculated to the same basis of 100 grams in 100 c.c., do not give the same value, but differ in the first decimal. This indicates that Specific Rotary Power is slightly influenced by the concentration of the solution tested; as expressed by Landolt's formula:—

$$\text{Specific Rotary Power of Sucrose} = 66\cdot435 + \cdot0087C - \cdot000235C^2,$$

when C varies from 5 to 65 grams per 100 c.c.

On substituting different numerical values for C, the Specific Rotatory Power may be expressed as a curve, the

¹ The above instruments, and methods of using them, are described in Browne's *Handbook of Sugar Analysis*.

highest point of which corresponds to 20 grams in 100 c.c. In order to compare the rotatory powers of different sugars it is therefore necessary to test solutions of equal concentrations.

Sucrose, glucose, and most other sugars rotate the plane of polarised light "clockwise," or *to the right*; and are called "dextro-rotatory." Fructose, and a few other sugars rotate in the opposite direction, or "counter-clockwise"; and are therefore called "lævo-rotatory." The former are said to have a *positive* rotation (Sucrose = + 66·5) and the latter a *negative* rotation (Fructose = - 92·8).

(6) *Boiling Points of Sucrose Solutions.*—The boiling point of water is raised by dissolving sugar therein, and such increase is directly proportional to the concentration, at a given pressure; but is constant, for equal concentrations, under different pressures. For example, at atmospheric pressure, water boils at 212° F., and an 80% sugar solution boils at 230·6° F. The boiling point is thus raised 18·6° F. by the dissolved sugar. When the pressure is reduced to 2 lbs. per sq. inch (absolute), water boils at 126° F., and an 80% sugar solution at 144·6° F.; the boiling point being again raised 18·6° F. by the dissolved sugar.

(7) *Viscosity of Sucrose Solutions* (see Chapter XXI, p. 266).

The foregoing physical properties of sucrose are brought together in Table I (p. 109). The first column gives the values for pure water; the following six columns give the values for sucrose solutions of different concentrations; and the last column, the values for solid or crystallised sucrose.

(b) *Chemical Properties of Sucrose*

(1) *Action of Heat.*—Perfectly dry sucrose can be heated to 160° C. without decomposition; it then melts, forming a non-crystalline substance (barley-sugar). In the presence of moisture, sucrose commences to decompose at a temperature of about 100° C., becoming dark in colour (due to the formation of caramel), and liberating water. When dry sucrose is

heated continuously at 160° C., it slowly decomposes into a mixture of glucose and fructosan; thus:—

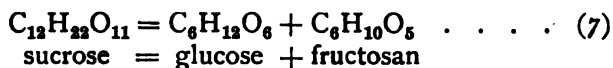

At higher temperatures, sucrose breaks up more completely; water vapour being evolved, and a dark-coloured, non-crystalline residue of caramel being left. On heating the latter at a still higher temperature, it decomposes, with evolution of:— carbon dioxide, carbon monoxide, formic acid, acetone, etc. The non-volatile residue of coke or carbon is completely converted into carbon dioxide gas on heating strongly in contact with air.

(2) *Action of Heat on Dilute Solutions of Sucrose.*—By prolonged heating at the boiling point, the dissolved sucrose slowly combines with water, and breaks up into equal parts of glucose and fructose, thus:—

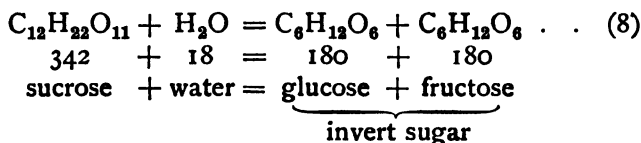

$$\text{Or} \quad 95 \quad + \quad 5 \quad = \quad 100$$

This change is much more rapid at a temperature of 140°–150° C., also at temperatures much below 100° C. if mineral acids are present (see (3) below). The chemical change is accompanied by a change in the optical rotation of the solution, for the specific rotatory power of sucrose is +66·5, of glucose +52·8, and of fructose –92·8.

$$\begin{array}{l} \text{Rotations.} \\ \text{Sucrose} \quad = \quad +66\cdot5 \\ \text{Invert Sugar} = \quad \frac{+52\cdot8 - 92\cdot8}{2} = -20\cdot0. \end{array}$$

As the initial and final rotations are in contrary directions, or *inverted*, the chemical change is termed “inversion” of sucrose, and the product is termed “invert sugar.”

(3) *Action of Dilute Acids on Sucrose Solutions.*—Inversion is much more rapid when the solution is made slightly acid; the acid acting as a catalyst, and remaining unchanged. In-

version by means of any acid is therefore represented by the same equation (8). The rate of inversion has been investigated by Ostwald, who established the following laws:—

- (a) In the presence of strong mineral acids, a constant proportion of the sucrose present is inverted during each unit of time; the value of this constant depending on the particular acid used.
- (b) When equal quantities of the same acid act on different quantities of sucrose, diluted to a constant volume, the rate of inversion remains the same. Hence, concentrated sucrose solutions can be completely inverted by small quantities of acid.
- (c) The rate increases rapidly with rise of temperature.
- (d) The rate increases proportionally with the concentration of the acid.

Taking the inverting velocity of hydrochloric acid as 100, those of other acids was determined by Ostwald under the same experimental conditions, and for a temperature of 25° C., with the following results:—

TABLE II.—INVERTING VELOCITIES OF DIFFERENT ACIDS
Hydrochloric acid = 100.

Hydrobromic	111·4	Tartaric	3·08
Hydrochloric	100·0	Citric	1·72
Nitric	100·0	Formic	1·53
Sulphuric	53·6	Malic	1·27
Sulphurous	30·4	Lactic	1·07
Oxalic	18·6	Succinic	0·55
Phosphoric	6·2	Acetic	0·40

(4) *Action of Strong Acids.*—The same acids which cause inversion when present only in small quantities, effect a more complete decomposition of sucrose when added in a more concentrated form; and, especially, when heat is also applied. The sucrose molecule then breaks up into numerous simpler molecules, such as formic, humic, and levulinic acids. Concentrated sulphuric acid abstracts hydrogen and oxygen from the sugar molecule, leaving a black mass of carbon.

(5) *Action of Dilute Alkalis.*—At low concentrations, alkalis

have no chemical action on sucrose, even at the boiling point. If a sucrose solution be boiled with excess of lime for a long period, some lactic and acetic acids are formed, which combine with the alkali present to form lime salts. But, when cane- or beet-juices are heated for short periods with lime to precipitate the non-sugars, the sucrose remains unaffected.

(6) *Action of Strong Alkalis.*—Sucrose combines with alkalis to form alkaline compounds, termed saccharates (see below). When heated, these compounds slowly decompose, yielding lactic, formic, acetic, and humic acids, which combine with the alkali present to form salts.

(7) *Action of Oxidising Agents.*—Sucrose is not readily oxidised, and is therefore not affected by free oxygen gas, or ozone. Finely-ground bone-char, added to a concentrated sucrose solution heated to 90° C., rapidly oxidises the sugar on exposure to the air, with liberation of steam. Nitric acid oxidises sucrose, first to saccharic acid, and further to tartaric, oxalic, and uric acids. Sucrose does not reduce Fehling's Copper Solution (p. 119).

(8) *Action of Yeast.*—Yeasts are living organisms, consisting of spherical or oval-shaped cells, about $\frac{1}{1000}$ inch in diameter. Owing to their ability to decompose sugars, with formation of alcohol, these organisms are termed *Saccharomycetes*. The cells multiply by "budding," or the extrusion of a new cell, or bud, from the parent-cell; the bud growing in size, and finally separating from the parent-cell. Yeast may therefore be termed a microscopic plant.

The fermentation of glucose, or of fructose, by the action of yeast is shown in the following equation:—

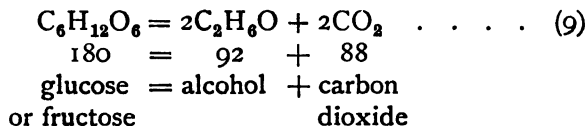

This is effected by an enzyme or soluble ferment—*zymase*, contained in the yeast cell, from which it can be extracted as a clear solution of non-living matter. The action of yeast on sucrose is described below.

(9) *Action of Invertase, or Sucrase.*—This enzyme is also

contained in the yeast cell, and can be extracted from it as a clear solution. It inverts sucrose by catalytic action, thus resembling inversion by dilute acids, but invertase acts less rapidly. The action of yeast on sucrose is therefore twofold, namely :—

- (a) Inversion, due to the enzyme invertase (equation 8).
- (b) Fermentation of the resulting invert sugar, due to the enzyme zymase (equation 9).

Fermentation plays an important part in the sugar industry, because that portion of the extracted sucrose which fails to crystallise, and is found in the molasses, can be converted into alcohol, and sold in that form.

Compounds of Sucrose

Sucrose combines with alkalis to form alkaline compounds, called saccharates. The most important of these are the calcium and strontium saccharates.

Calcium saccharates :—

Monocalcium saccharate	$C_{12}H_{22}O_{11}CaO$.	Very soluble in cold and hot water.
Dicalcium "	$C_{12}H_{22}O_{11}2CaO$.	Soluble in 33 parts of cold water.
Tricalcium "	$C_{12}H_{22}O_{11}3CaO$.	" " 100 " "boiling water.
		" " 200 " "boiling water.

The alkalinity of each of these compounds corresponds exactly to the proportion of lime present. The sucrose molecule remains intact, and can be completely separated from the compound by the addition of carbon dioxide, thus :—



On boiling a clear solution of the monocalcium saccharate, it becomes opaque, owing to the conversion of the monobasic into the less soluble tribasic compound, a part of the sucrose being set free, thus :—

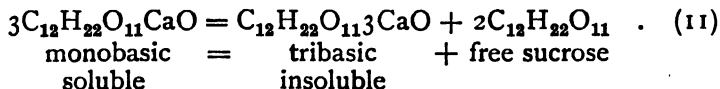

The dibasic compound is also converted into the tribasic compound and free sucrose when boiled.

Strontium saccharates :—

Monostrontium saccharate	$C_{12}H_{22}O_{11}SrO$
Distrontium "	$C_{12}H_{22}O_{11}2SrO$

GLUCOSE AND FRUCTOSE

These sugars are so similar in their chemical properties that they may be conveniently described side by side.

2. *Glucose, or Dextrose, C₆H₁₂O₆*

This occurs in many plants. Juice from ripe cane contains from 0·5 to 2·0%, but very minute percentages are found in beet juice. Grapes contain as much as 13·0%, giving rise to the earlier name—grape-sugar. Commercial glucose is manufactured from starch by the action of acids.

3. *Fructose, or Levulose, C₆H₁₂O₆*

This occurs in most sweet fruits, hence, the earlier name—fruit-sugar. It is always present in the juice from unripe cane and beet, but diminishes during ripening. The presence of both fructose and glucose in the juice of overripe cane and beet is due to inversion of sucrose. As the material entering the factory is never uniformly ripe, the extracted juice usually contains small percentages of fructose.

(a) *Physical Properties*

(1) *Crystalline Forms.*—Anhydrous Glucose, C₆H₁₂O₆, crystallises in transparent, rhombic crystals, which separate from warm solutions. Glucose Hydrate, C₆H₁₂O₆·H₂O, crystallises in transparent crusts, or nodular masses, which separate from cold solutions. The former melts at 146° C., and the latter at about 86° C.

Fructose crystallises from strong alcoholic solutions in the form of needles, or in crusts of transparent prisms, which melt at 95°–100° C. In impure solutions, such as cane and beet juices, both glucose and fructose are uncrystallisable, and are consequently found in the molasses.

(2) *Solubilities.*—At 15° C., 100 parts of water dissolve 81·68 parts of anhydrous glucose; and 97·85 parts of glucose hydrate.

Fructose is more soluble than glucose in cold water. Both sugars are slightly soluble in methyl- and ethyl-alcohols; the solubility increasing with the dilution of the alcohol,

and with rise in temperature. Fructose is distinguished from all other sugars by its solubility in mixtures of alcohol and ether, also in ethyl-alcohol saturated with ammonia. Fructose differs from glucose in its solubility in cold glycerine, and acetone.

(3) *Specific Gravities of Solutions.*—Solutions of glucose and fructose possess the same specific gravities, for equal concentrations; but these are slightly lower than the corresponding specific gravities of sucrose.

(4) *Refractive Indices.*—Solutions of glucose and fructose, of equal concentrations, have equal refractive indices, which differ very slightly from the corresponding values for sucrose.

(5) *Specific Rotatory Powers.*—In this respect, the two sugars differ entirely. For equal concentrations of 10 grams in 100 c.c., and at 20° C., the rotatory powers are:—

$$\text{Glucose} = + 52.8, \text{ and Fructose} = - 92.8.$$

The Specific Rotatory Powers of sucrose and glucose are very slightly influenced by variations in concentration and temperature; whilst that of fructose is appreciably influenced by concentration, and still more by temperature. For each degree rise in temperature, the rotatory power of fructose is reduced by 0.625°, so that a rise in temperature from 20° to 84° C. reduces the rotation by $64 \times 0.625 = 40^\circ$, giving $- 52.8$. This is the rotation of glucose, but negative instead of positive (see "Invert Sugar" below).

(b) *Chemical Properties of Glucose and Fructose*

(1) *Action of Heat.*—Both sugars (in a dry state) are decomposed on heating to 160°–170° C., one molecule of water being liberated; thus:—

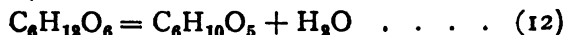

The other product is glucosan, from glucose; and fructosan, from fructose. On further heating, this solid residue blackens and swells, evolving various gases, and leaving a residue of coke. On further heating in presence of air the coke is converted into carbon dioxide gas, leaving no residue. Moist fructose begins to decompose when heated to 100° C., water and carbon dioxide being liberated. On this account,

materials containing fructose should be first dried at 60° – 70° C., and drying completed at 100° C., in determining the percentage of moisture.

(2) *Action of Heat on Solutions.*—Solutions of glucose in water can be heated to boiling point without change, but those of fructose decompose, with formation of acids and dark-coloured products.

(3) *Action of Dilute Acids.*—Very dilute acids, which cause inversion of sucrose, have no effect on the glucose and fructose thus obtained, at moderate temperatures. On prolonged heating, the rotatory power of fructose is modified, but without apparent decomposition.

(4) *Action of Strong Acids.*—When heated to 80° C. with 5% of concentrated sulphuric acid, both sugars decompose in the same manner as sucrose, forming dark-coloured, acid compounds of humic, levulinic, and formic acids. Fructose is more readily decomposed than glucose by the same concentration of acid, and at the same temperature.

(5) *Action of Dilute Alkalis.*—When the alkalinity is low, and the temperature below 60° C., glucose is partially transformed into two other sugars—fructose and mannose, in such proportions that the negative rotation of the fructose is counterbalanced by the combined positive rotations of the two other sugars, causing the mixture to become optically inactive. The same three sugars are formed when either fructose, or mannose, are separately heated with dilute alkali. This conversion of one sugar into others is due to a rearrangement of the constituent atoms within the molecule. The first step is, probably, the formation of an unstable molecule, which is readily convertible into one or other of the more stable forms—glucose, fructose, or mannose.

(6) *Action of Strong Alkalis.*—This depends on the nature of the alkali, the degree of alkalinity, and the temperature. At temperatures below 55° C., alkalis decompose dilute solutions of glucose and fructose, with the formation of lactic acid which combines with the alkali to form a lactate. This is a colourless and stable compound, which causes no trouble in the sugar factory.

At higher temperatures, various dark-coloured, acid com-

pounds are formed. Thus, at 70° C., glucose and fructose are transformed into the isomeric compounds—glucinic and saccharinic acids, which combine with the free alkali to form neutral salts. Both these substances are formed when cane juice is heated with an excess of lime. Glucinate of lime is an unstable compound, decomposing spontaneously, with the formation of carbonic, acetic, formic, and humic acids. Consequently, the alkaline cane juice becomes distinctly acid during concentration to syrup; and the massecuite, derived from this syrup, may appear to boil or ferment, owing to the decomposition of the glucinate of lime, and evolution of gaseous products. At the boiling point, strong alkalis decompose solutions of glucose and fructose with the formation of similar dark-coloured, acid compounds.

(7) *Action of Reducing Agents.*—Sodium amalgam reduces glucose to sorbite, but reduces fructose to a mixture of sorbite and mannite.

(8) *Action of Yeast.*—This was referred to under “Sucrose” (see p. 112).

Before considering the other chemical properties of glucose and fructose, it is desirable to refer to their molecular structures. The monosaccharides have been previously defined as:—“the first oxidation products of alcohols, containing more than one atom of carbon, to each of which an hydroxyl-group (—OH) is attached.”

The simplest alcohol of this type is glycol, C₂H₆O₂, which, on oxidation, yields the simplest possible sugar, thus:—

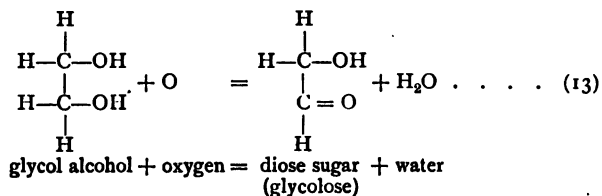

When an alcohol contains three or more carbon atoms, two distinct oxidation products become possible, giving rise to two types of sugars. For example, glycerol, C₃H₈O₃, gives the following:—

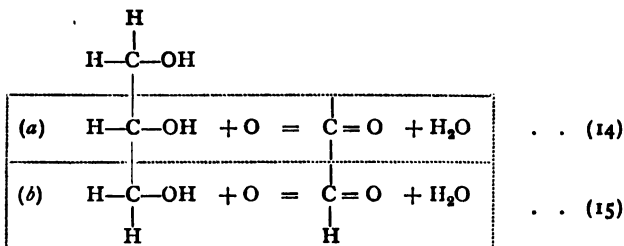

The oxidised product in (a) is the carbonyl- or ketone-group $\left(\begin{array}{c} | \\ \text{C}=\text{O} \end{array} \right)$; whereas that in (b) is the aldehyde-group $\left(\begin{array}{c} | \\ \text{C}=\text{O} \text{ or } \text{HC}=\text{O} \\ | \\ \text{H} \end{array} \right)$, as in glycolose (above).

The oxidation of glycerol may therefore be written as follows:—

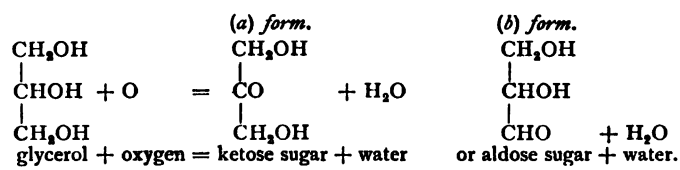

Any ketose sugar contains the group—

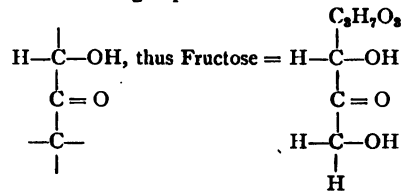

and any aldose sugar contains the group—

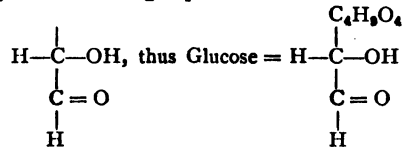

and both sugars contain the common group—

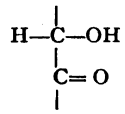

(9) *Action of Oxidising Agents.*—Glucose and fructose are distinguished from sucrose by their capacity to abstract oxygen from metallic oxides in the presence of alkalis. The sugar molecule thus becomes oxidised to form acid products, whilst the metallic oxide is reduced, either to the metallic state, as in equation (16), or to a lower, or suboxide, as in equation (17). In both equations only the aldehyde-group ($\text{H}-\overset{\text{H}}{\underset{\text{H}}{\text{C}}}=\text{O}$) of the glucose molecule is shown.

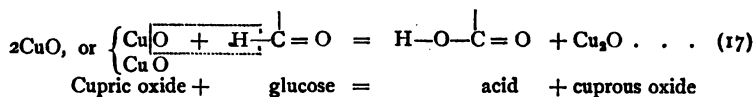
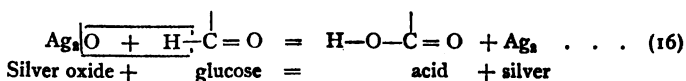

Tollens' Silver Reagent.—One gram of silver nitrate is dissolved in 10 c.c. of water, and one gram of sodium hydroxide is dissolved in 10 c.c. of water. Equal parts of the two solutions are mixed, and ammonia added, drop by drop, until the precipitated silver oxide is completely dissolved. A few drops of this ammoniacal silver oxide solution are added to about 10 c.c. of a very dilute sugar solution in a perfectly clean test-tube. One part of glucose in 1000 parts of water produces a mirror of metallic silver on the sides of the test-tube within 15 minutes; or instantly, on warming the solution. One part of glucose in 100,000 parts of water produces a visible mirror on standing for two days in the cold; or, more rapidly, on gently warming the solution. As there is some risk of forming explosive silver compounds by heating the solution, the test-tube should be emptied and cleansed as soon as the mirror is formed.

As Tollens' reagent is reduced by sucrose and other soluble carbohydrates which fail to reduce cupric oxide (equation 17), it is of little value in sugar analysis, apart from its high cost.

*Barreswil's (Fehling's) Copper Reagent*¹

Two solutions are prepared, as follows :—

Solution A contains 34.64 grams of crystallised Copper Sulphate in 500 c.c.
 Solution B contains 173 grams Rochelle Salts } in 500 c.c.
 50 ,, Sodium Hydrate }

¹ This was first employed in sugar analysis by the French chemist Barreswil, in 1844, and subsequently by Fehling in 1848.

Equal volumes of A and B are mixed before applying the test. The copper sulphate contains the soluble base—cupric oxide (CuO). On heating the reagent with a dilute solution of glucose, or of fructose, the cupric oxide parts with half of its oxygen, and is precipitated as insoluble red cuprous oxide (suboxide of copper), as shown in equation (17). As the quantity of reduced cuprous oxide is proportional to the quantity of sugar acting upon the copper reagent, the latter is employed in the quantitative determination of glucose, fructose, and many other sugars.

All sugars which precipitate cuprous oxide are therefore termed “reducing sugars,” and a very large number are known. Sucrose, raffinose, and a very few others are non-reducing. As the different reducing sugars reduce different quantities of cupric oxide per unit weight they are said to possess different “reducing powers.” For example, fructose has about 92% of the reducing power of glucose.

Aldose sugars are more readily oxidised than ketose sugars by weak oxidising agents. Thus, glucose, treated with bromine-water, becomes oxidised in a few days; whereas, under the same conditions, fructose remains unchanged unless the solution be heated, or left for a much longer period. The oxidised glucose yields an acid containing six carbon atoms (the same as the original sugar); whereas the oxidised fructose molecule splits up into several acids, each containing a small number of carbon atoms.

Similarly, a solution of iodine in borax slowly oxidises any aldose sugar (glucose), but has no action on ketose sugars (fructose). Strong oxidising agents, such as nitric acid, convert aldose sugars into dibasic acids, but ketose sugars yield numerous simpler acids, such as formic and oxalic acids. Free oxygen and ozone are capable of oxidising both glucose and fructose in the presence of alkalis. Hydrogen peroxide acts energetically, with evolution of heat, and formation of formic, acetic, and tartaric acids.

(10) *Reactions with Phenylhydrazine.*—This reagent was introduced by Fischer, in 1884, as a means of separating and identifying sugars, and for studying their molecular structures. Aldose and ketose sugars, when treated with an equal

weight of phenylhydrazine, $\text{H}_2\text{NNHC}_6\text{H}_5$, yield crystallisable compounds called hydrazones; which, for different sugars, possess different degrees of solubility in cold water, and may thus be separated from each other. For example, mannose phenylhydrazone is almost insoluble in cold water, and may be completely separated from most other hydrazones which separate very slowly. Glucose and fructose yield isomeric phenylhydrazones— $\text{C}_{12}\text{H}_{18}\text{N}_2\text{O}_5$, having different melting points and solubilities, but not readily separated from each other.

When the phenylhydrazine is added in excess, and the mixture heated, two molecules of the reagent unite with one molecule of sugar to form an osazone. This is much less soluble in water than the corresponding hydrazone, and consequently more suitable for rapid separation, and identification. Glucose and fructose yield one and the same osazone, $\text{C}_{18}\text{H}_{24}\text{N}_4\text{O}_4$, which crystallises in yellow needles, melts at $204^\circ\text{--}205^\circ\text{C}$., and is soluble in hot alcohol. This permits of the separation of either glucose or fructose from certain other sugars, whose osazones are less or more soluble.

Methylphenylhydrazine does not react with glucose (and other aldose sugars); but, with fructose, yields a methylphenylosazone, $\text{C}_{20}\text{H}_{26}\text{N}_4\text{O}_4$, which crystallises in yellow needles, melts at $158^\circ\text{--}160^\circ\text{C}$., is very slightly soluble in cold water and alcohol, but readily soluble in hot alcohol, acetone, chloroform, and pyridine.

(II) *Colour Reactions with Acids and Phenols.*—If concentrated sulphuric acid be added to a very dilute sugar solution, in such a manner that the two liquids do not mix but form separate layers, a dark brown ring develops at the point of contact in the presence of a ketose sugar (fructose), but not in the presence of an aldose sugar (glucose). If a few drops of an alcoholic solution of α -naphthol, thymol, resorcin, orcin, or phloroglucin be added to the sugar solution before introducing the acid, the ring produced is coloured from bright red to deep violet. Or, the sugar solution, phenol, and acid may be mixed with alcohol and gently heated, when the entire liquid becomes intensely coloured, producing one or more absorption bands when examined in a spectroscope.

The time required for the colour to develop, and the number of absorption bands, are characteristic of aldose and ketose sugars. Thus, under definite conditions of concentration of the sugar solution, acid, and alcohol, any sugar containing the ketone-group gives a strong colour almost immediately; whereas, with aldose sugars, the colour only develops after about 30 minutes. By increasing the proportion of alcohol in the reacting mixture, the coloration produced by an aldose sugar may be rendered so faint as to yield no absorption bands; whereas ketose sugars develop their full colour in from 15 to 30 minutes, and produce distinct absorption bands.

These colour reactions serve to distinguish between ketoses and aldoses, but it is important to note that any compound sugar which yields a ketose sugar on hydrolysis, gives the same intense colour as the latter. Thus, sucrose could not be distinguished from pure fructose (ketose), because sufficient fructose is produced by the hydrolysing action of the acid on the sucrose. These colour reactions are, in fact, frequently employed for detecting minute traces of sucrose in waste waters and condensed vapours in the sugar factory. The α -naphthol test gives a distinct lilac-coloured ring when the liquid tested contains only one part of sucrose in ten million parts of water.

Invert Sugar, $2C_6H_{12}O_6$

This being a mixture of equal parts of glucose and fructose, it necessarily combines the properties of its constituents, which have been described above. The most interesting of these properties is the specific rotatory power, previously referred to in connection with the inversion of sucrose by heat. As shown on p. 110, the sum of the specific rotatory powers of glucose and fructose, namely, $+52.8 - 92.8$ gives -20 for invert sugar; the negative rotation being due to the excess rotation of fructose over glucose. As a rise in temperature decreases the rotatory power of fructose, without influencing the rotatory power of glucose, the two rotations become equal, but opposite in character, at a temperature of $84^\circ C.$; thus rendering the mixture optically inactive.

The change in rotation of a 20% invert sugar solution at the two different temperatures is shown below.

$$\begin{aligned} \text{At } 20^{\circ} \text{ C. (standard temp.)} &= \left\{ \begin{array}{l} 10\% \text{ Fructose} - 92.8 \\ 10\% \text{ Glucose} + 52.8 \end{array} \right\} - \frac{40}{2} = -20.0 \\ & \qquad \qquad \qquad \text{Sp. Rot. Power.} \\ \text{At } 84^{\circ} \text{ C.} &= \left\{ \begin{array}{l} 10\% \text{ Fructose} - 52.8 \\ 10\% \text{ Glucose} + 52.8 \end{array} \right\} \text{nil} = \text{nil.} \end{aligned}$$

4. RAFFINOSE, OR MELITRIOSE, $C_{18}H_{32}O_{16}$

Raffinose belongs to the third group of sugars, or trisaccharides (see p. 105), for it can be decomposed into three monosaccharides—glucose, fructose, and galactose.

Raffinose was discovered in 1876, in the molasses obtained in a beet-sugar refinery; the name being derived from the French verb *raffiner* = to refine. It has, also been extracted from beet juice, but healthy beets contain only from 0.01 to 0.02% of raffinose, and it does not appear to be present in the sugar-cane. A very brief account of its properties will be sufficient.

(a) Physical Properties

Raffinose Hydrate, $C_{18}H_{32}O_{16} \cdot 5H_2O$, crystallises from an aqueous solution in pointed needles, or prisms, containing 5 molecules of combined water. On heating for some hours at 80° C. , and finally to 105° C. , the combined water is driven off, leaving anhydrous raffinose, $C_{18}H_{32}O_{16}$, which is an amorphous and hygroscopic substance. Raffinose is more soluble than sucrose in hot water, but less soluble in cold water. It is soluble in methyl alcohol, but not in ethyl alcohol, or ether. An aqueous solution of raffinose has a slightly lower specific gravity, and refractive index, than a solution containing an equal percentage of sucrose. The specific rotatory power of raffinose hydrate is +104.7, and of the anhydride +123.2. It therefore rotates much more strongly than sucrose, and in the same direction.

(b) Chemical Properties

Raffinose resembles sucrose in the following points. It is not readily oxidised, and therefore does not reduce Barreswil's (Fehling's) Solution; it is not readily decomposed by dilute

alkalis even at boiling point; and it does not form hydrazones and osazones when treated with phenylhydrazine. It also resembles sucrose in undergoing hydrolysis when heated with dilute acids, but yields a mixture of three sugars, thus:—

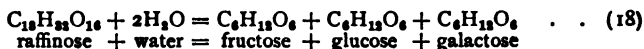

This causes a change in specific rotatory power from +104.7 for raffinose hydrate, to +12.5 for the mixed products; or a decrease of 92.2. The change may also be effected in two stages, thus:—

(a) With 10% acid, and heating for 10 minutes at 68° C.; or by the action of invertase instead of the acid:—

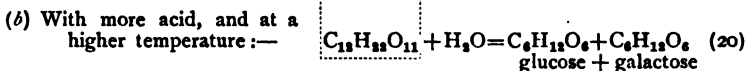

SUMMARY

The chief characteristics of the foregoing sugars may now be briefly reviewed.

(1) All the monosaccharides, and a few disaccharides (lactose, maltose, etc.), can abstract oxygen from a metallic oxide, and are therefore termed "reducing sugars." Most of the known sugars possess this property, but a few, including sucrose and raffinose, are non-reducing. The sugar-molecule, when thus oxidised, forms acid products.

(2) The reducing sugars form two subclasses:—aldoses, (resembling aldehydes), and ketoses (resembling ketones), which react differently towards certain reagents. Thus, the colours produced on addition of mineral acids and phenols develop much more rapidly in the case of ketoses (fructose, etc.) than with aldoses (glucose, etc.), because the former are more readily decomposed by acids. Bromine-water and iodine oxidise aldoses more readily than ketoses. Dilute nitric acid oxidises aldoses to form an acid containing the same number of carbon atoms as the sugar, but ketoses break up into simpler acids, containing fewer carbon atoms than the original sugar.

(3) All monosaccharides, and a few disaccharides (reducing sugars), form crystalline compounds with phenylhydrazine, termed hydrazones and osazones. These vary in solubility and in melting point, and frequently permit the separation of one sugar from a mixture of sugars. Methylphenylhydrazine reacts with ketoses (fructose, etc.), yielding a crystalline osazone, but not with aldoses (glucose, etc.). Other derivatives of phenylhydrazine are employed for separating certain sugars from mixtures.

(4) The compound sugars, sucrose and raffinose, are more stable compounds than the monosaccharides. As they do not contain free aldehyde- and ketone-groups, they neither reduce Barreswil's (Fehling's) Reagent, nor form crystalline compounds with phenylhydrazine, nor are they readily decomposed by alkalis. But, as they yield glucose and fructose on hydrolysis with dilute acids, they give the same colour reactions with mineral acids and phenols.

(5) The most characteristic physical property of the sugars is found in their action towards plane-polarised light, this property being utilised in the analysis of single sugars, and of mixtures of sugars. Sucrose, glucose, and raffinose rotate to the right, or positively, but unequally; whereas, fructose rotates to the left, or negatively. Compound sugars may frequently be identified by the change in optical rotatory power before and after hydrolysis with dilute acids. When hydrolysed by means of enzymes, the products obtained may differ from those obtained by hydrolysis with acids, and thus assist in identifying the original sugar.

CHAPTER XIII

COMPOSITION OF THE CANE AND EXTRACTED JUICE

THE sugar-cane stem contains about 70% of water, in which sucrose and various other substances are held in solution, forming about 88% by weight of juice in the stem; the remaining 12% representing insoluble cane fibre. The composition varies in different varieties of cane, and even in the same variety when grown on different soils, and under different climatic conditions. The composition of ripe cane falls within the following limits:—

Water	70 to 75%	
Sucrose	11 ,, 16%	average = 13.0%
Reducing sugars	0.4 ,, 2%	
Organic non-sugars	0.5 ,, 1%	
Mineral matters	0.5 ,, 1%	
Fibre	10 ,, 16%	

The extracted juice is a dark opaque liquid containing numerous solid matters in suspension, and also a considerable quantity of emulsified air; the air enters the juice during milling, and forms a froth on the surface. The suspended solid matters include fine particles of fibre, cane-wax, and chlorophyl-granules, derived from the canes; also clay, and fine sand, derived from the soil adhering to the canes. The coarser particles of fibre ("cush-cush") are separated by mechanical strainers, which form part of the mill-equipment, but the strained juice is quite opaque, owing to the finer particles in suspension.

As stated in Chapters I and II, the living plant contains two distinct saps; namely:—

(a) *The sugar-sap* stored in the soft parenchyma cells, or pith, of the stem; and which contains in solution—sucrose, reducing sugars, organic acids, and their salts, and very little mineral matter.

(b) *The soil-water* ascending through the woody tissue from the roots to the leaves, and containing no sucrose, but only mineral matters absorbed from the soil.

To these we may add :—

(c) *Protoplasm*.—This is a semifluid substance, of very complex composition, and represents the “living matter” of the plant. It forms an interior lining of the vegetable cells in which the sugar-sap is stored, and contains water, nitrogen-compounds, and mineral matters, but no sugars.

The juice extracted by milling is a combination of these different fluids, in varying proportions, depending on the pressure applied. Moderate pressure extracts (a) in preference to (b) and (c), and therefore yields the purest and richest saccharine juice. Under heavy pressures (as in the multiple mill), increasing quantities of (b) and (c) are extracted, and the heaviest pressure (in last mill-unit) also extracts colouring matters from the hard rind of the cane, and nitrogen-compounds from the hard fibrous “nodes.” As the extraction of the juice is assisted by saturating the fibre with water during milling, a variable quantity of water mixes with, and dilutes the juice. If hot water be used for saturation, it may extract gummy matters from the cane fibre, thus adding non-sugars to the juice.

These considerations indicate that the composition of mill-juice varies even more than that of the original canes, but the following figures are typical of undiluted juice (free from saturation water):—

Water	83.0	} dissolved solid matters or “Brix” = 17.0 (see p. 106) Purity = $\frac{15 \times 100}{17} = 88.2$ (see p. 147)
Sucrose	15.0	
Reducing sugars	1.0	
Organic non-sugars	0.5	
Mineral matters (ash)	0.5	
	100.0	

Of these constituents, the sucrose and reducing sugars (glucose and fructose) have been considered in the last chapter. The non-sugars are classified in Table III, below.

TABLE III.—NON-SUGARS IN CANE JUICE

Acids.	Nitrogen-compounds.	Colouring Matters.	Other Organic Non-sugars.	Mineral Matters.
<i>Organic Acids.</i> glycollic malic oxalic succinic tannic	<i>Organic Compounds.</i> albumin albumoses amines amino-acids nucleins peptones xanthene-compounds	<i>Soluble.</i> anthocyan saccharetin	<i>Soluble.</i> pectin gum (xylan)	<i>Mostly soluble.</i> alumina iron oxide lime magnesia potash soda sulphur chlorine
<i>Inorganic Acids.</i> phosphoric sulphuric silicic	<i>Inorganic Compounds.</i> of ammonia and nitric acid			
<i>In diseased Cane.</i> acetic	<i>Insoluble.</i> albumin	<i>Insoluble.</i> chlorophyl	<i>Insoluble.</i> cane-fibre cane-wax	<i>Insoluble.</i> silicates

ACIDS

The juice of ripe cane is slightly acid, corresponding to about 0.2%. About an equal quantity occurs in combination with the mineral bases (column 5) as salts. The percentage of acid is much higher in unripe cane, and therefore in the uppermost joints of ripe cane. Canes which have been cut, and kept for a few days, do not increase in acidity, as is commonly believed, although part of the sucrose may have been transformed into invert sugar. Diseased, and damaged cane may contain acetic acid formed by decomposition of the sucrose by bacteria; the extracted juice from diseased cane may even have a strong odour of acetic acid, and is then quite unsuitable for sugar manufacture.

In order to prevent inversion of sucrose when the juice is boiled, sufficient milk of lime must be added to render it neutral, or faintly alkaline; this lime also serving to precipitate certain of the dissolved non-sugars. The various acids (see Table III), are thus converted into lime salts; but, as most of these salts are soluble, they cannot be separated from the juice, and the lime required to neutralise the acids, also

remains in solution. The lime salt of oxalic acid is insoluble in water, but slightly soluble in dilute sugar solutions; the solubility decreasing during concentration of the juice to syrup. This causes the calcium oxalate to deposit as "scale" on the metal heating surface of the evaporator (especially in the last vessel of the multiple-effect evaporator, wherein the syrup reaches its maximum degree of concentration). Phosphoric acid also forms an insoluble lime salt, which deposits as "scale" during concentration of the juice to syrup.

Lactic, glucinic, and saccharinic acids may be formed by the chemical action of lime on the reducing sugars (glucose and fructose), as described in the last chapter. As acetic, glycollic succinic, and malic acids form hygroscopic lime salts, the molasses present in raw sugar crystals may absorb moisture from the atmosphere, causing the sugar to "sweat" during transport or storage, and reducing its market value (see p. 322).

NITROGEN COMPOUNDS

The element Nitrogen is an essential constituent of plants, and is obtained from the soil in the form of nitrates. On a cane-sugar estate, nitrogen is usually added to the soil in the form of nitrate of soda, or as sulphate of ammonia. The nitrogen compounds manufactured by plants are numerous and complex; the following proportions being found in cane juice, by Brown and Blouin:—

Albumin (coagulated by heat, and soluble in pepsin)	=	0.59%
Nuclein (" " but insoluble in pepsin)	=	0.40%
Albumoses and peptones (not coagulated by heat)	=	0.33%
Amino-acid (such as aspartic acid)	=	1.45%
Acid amines (such as asparagin)	=	2.32%
Compounds of ammonia	=	0.08%
Compounds of nitric acid	=	0.71%

Total compounds = 5.88% on cane

These percentages relate to a particular variety of cane, and vary greatly in different varieties. Assuming that all these compounds are extracted in the form of juice, containing 17% of total dissolved solids, the dry solids will contain $\frac{0.588 \times 100}{17} = 3.4\%$ of nitrogen compounds. As each compound contains only a small percentage of actual nitrogen

(albumin contains 16%), the above total of 0.588% would represent less than 0.10% of nitrogen on weight of cane.

According to Geerligs, the sugar-cane stem (without leaves) contains about 0.05% of nitrogen; the unripe top joints and leaves containing much more. The extracted juice, after being strained through cloth, contains about 0.036% nitrogen; but further filtration through filter-paper reduces the percentage, proving that a portion of the nitrogen occurs in an insoluble form (probably albumin).

Campagne found only 0.02% nitrogen in Java canes; half in the form of albuminoids, and half as amides. In the diluted juice extracted by a multiple mill, the albuminoid nitrogen was 38% of the total nitrogen. About 80% of the albuminoids, namely, the albumins and nucleins, are coagulated by heat, and can be separated from the juice by subsidence, or by filtration. Maxwell's analyses indicate the effect of this precipitation to be as follows:—

	Total Nitrogen.	
	Albuminoid Nitrogen.	Amide Nitrogen.
Mill juice	35%	65%
Clarified juice and syrup	3.3%	96.7%

Plant-albumin somewhat resembles egg-albumin, the chief solid constituent of "white of egg," and which coagulates on heating to 165° F. Milk-albumin also coagulates on heating.

COLOURING MATTERS

(1) *Chlorophyl*.—The green colour of the leaves of plants is due to a complex substance—Chlorophyl—which also occurs in the coloured exterior rind of the cane-stem as minute granules, embedded in the cellular structure of the leaf and rind. It is insoluble in water, but soluble in alcohol and ether, forming intensely green solutions; also in hydrochloric and sulphuric acids. Chlorophyl is the active agent in the manufacture of carbohydrates by plants (see Chapter I); but this function has been proved to depend on the

presence of iron salts. Plants grown in liquids or soils entirely free from iron produce colourless leaves; but, on the addition of a few drops of sulphate or chloride of iron to the soil, the leaves develop their full green colour in 3 or 4 days. Being insoluble in cane juice, chlorophyll is removed, along with the albuminoids, when the limed and heated juice is subsided or filtered.

(2) *Anthocyan*.—This is a dark colouring matter in the rind of purple canes. It is soluble in water, and therefore in cane juice, rendering the latter dark in colour. It is only partially bleached when the juice is treated with sulphur dioxide, and is only partially precipitated by lime, unless this is added in large excess (from 7 to 10% by volume of milk of lime of 20 Beaumé), as in the "Carbonation Process" to be described hereafter.

(3) *Saccharetin*.—When the colourless cane fibre is moistened with alkali, it assumes a bright yellow colour, which disappears on moistening the fibre with an acid. This colouring matter is difficult to extract from the fibre, being very slightly soluble in water, rather more soluble in alcohol, and insoluble in ether. Its presence in the juice causes the latter to become yellow on the addition of an alkali, but the colour is bleached by sulphur dioxide. It is believed that "Demerara Sugar" owes its fine yellow colour to saccharetin, or its compounds. On exposure to air, saccharetin oxidises to a bright red compound, often observed in the pith of diseased sugar-cane. Not being precipitated by alkalis, saccharetin is not separated from the juice during clarification and filtration.

(4) *Tannins*.—It has long been known that traces of dissolved iron salts in the juice or syrup cause coloration of the sugar crystals obtained therefrom; so that sugar which is intended to be white, assumes a greyish tint, which lowers its market-value. As only minute quantities of iron salts are present in the raw juice, and in the lime used for clarification, the presence of this impurity is accounted for by the slight solubility of metallic iron in juice, especially when acid, by contact with evaporators, tanks, etc. The coloration of massecuites and sugars is frequently very marked when the manufacturing season commences, owing to the presence of

rust in the various vessels and piping. But iron salts cause the same trouble at a later date, after the rust has been washed away, or dissolved.

Geerligš attributes the grey coloration of sugars to the presence of iron saccharate, but Schneller has proved that the addition of ferric salts causes no coloration in solutions of pure sucrose and glucose, and very little change in colour when added to clarified cane juice. He accounts for the coloration by the presence of polyphenols or tannins, which form dark compounds with iron; and quotes the following authorities in support of his view.

W. Krueger (*Zuckerrohr und seine Kultur in Java*) states that tannin was detected in the sugar-cane by Szymanski. C. A. Browne (*Louisiana Bulletin*, No. 91) notes the presence of tannin in the growing joints and especially near the "eyes." Bertrand has explained the darkening of vegetable tissues on exposure to air, as due to the action of oxidising enzymes upon various tannins. Geerligš (*Cane Sugar and its Manufacture*) records the presence of minute quantities of tannin, of unknown composition, in growing canes, and in the top joints of ripe canes.

Polyphenols have been detected in the growing organs of various plants, and in the "eyes" and upper joints of the sugar-cane. If the crushed cane (bagasse) be soaked in a solution of a ferric salt, the "eyes" are stained black; and a water-extract of the "eyes" gives a greenish-black colour on adding a ferric salt. The lower, mature joints give much less coloration than the immature upper joints, and also yield a lighter-coloured juice. As to the identity of the polyphenol in cane juice, Schneller remarks that catechol, or one of its derivatives, is indicated by the following colour-reactions of the juice—greenish-black with ferric chloride, and red on addition of sodium carbonate. Polyphenols may even be formed during treatment of the juice in the factory, by the decomposition of reducing sugars by lime (see below). Schneller concludes as follows:—

(1) Traces of iron are sufficient for the production of a dark colour in juices containing polyphenols. (2) Reducing agents (sulphur dioxide and hydrosulphites) cause only

a temporary bleaching action, the dark colour returning on oxidation. (3) The dark tint of "Plantation White Sugars," which increases on storage, is due to traces of phenol-iron compounds. (4) A permanently light-coloured juice may be obtained by:—(a) complete elimination of iron from the juice, and avoiding contact with iron vessels during manufacture; (b) elimination of polyphenols from juice by absorption in bone-char, vegetable carbons, etc.; (c) the polyphenol-content of juice can be reduced by removing more of the upper joints ("topping low"), before the canes are sent to the factory. The practical methods of preventing the darkening of the syrups and sugars is at present limited to the following:—(a) reduction of ferric to colourless ferrous compounds by the action of reducing agents; (b) decomposition of the phenol-iron compound by acidification.

(5) *Decomposition Products*.—Dark-coloured compounds may be produced during the chemical treatment of the juice and subsequent boiling, owing to the decomposition of reducing sugars in alkaline juice with formation of glucinic acid, apo-glucinic acid, and humic compounds. Glucinic acid yields dark compounds with ferric salts; and, on prolonged heating, yields polyphenols. Consequently, more polyphenols may be formed during factory operations than were originally present in the juice. Caramel, resulting from decomposition of sucrose by heat, is always present in variable quantities in cane molasses and in low-grade cane sugars.

OTHER ORGANIC NON-SUGARS

(1) *Pectin*.—This is a constituent of many fruits, such as apple, pear, plum, and various berries; also of numerous roots, such as beet, turnip, carrot, etc. It is soluble in water, but gelatinises on standing, and is precipitated from its aqueous solution by alcohol. When dried, it forms a white powder, soluble in water. On heating with dilute alkalis, pectin is converted into compounds closely resembling gums, the composition of which is uncertain. Pectin is a normal constituent of ripe cane, but the percentage varies considerably in different varieties, and is higher in unripe cane. It can be precipitated from the juice by adding a sufficient

quantity of lime, but is only partially precipitated by small additions of lime. Syrup, containing much pectin in solution, boils with difficulty in the vacuum pan, owing to its viscosity.

(2) *Gum*.—The gums belong to the polysaccharide group of carbohydrates (p. 4); and may be divided into two classes:—(a) natural gums, or pentosans; and (b), mucilages, and pectic compounds. Natural gums are soluble in water, and precipitated therefrom by acetic acid and alcohol. Cane-gum consists mainly of xylan, which, on hydrolysis with acids, yields the sugar xylose. Browne and Blouin found 20% of xylan in dry cane fibre. It can be extracted from the fibre by boiling water, and, more rapidly, by boiling with dilute alkali. From this solution, it is precipitated by alcohol in the presence of acetic acid, and is then soluble in hot water. The solution becomes opaque and gelatinous on cooling, but is rendered clear by the addition of soda or potash. Xylan is precipitated by an excess of lime, or of baryta, also by lead acetate. During chemical treatment of the juice, cane-gum is only partially precipitated when the juice is made slightly alkaline with lime-milk; but about 70% of the total gum is precipitated in strongly alkaline juice.

(3) *Dextran and Levan*.—These gummy compounds are not normal constituents of the juice, but may be formed by the action of bacteria. The organism *Leuconostoc mesenterioides* produces dextran, $C_6H_{10}O_6$, a gelatinous substance, insoluble in water, but soluble in alkalis. On hydrolysis with acid, dextran yields dextrose (glucose). The organism multiplies very rapidly in cold alkaline juice, producing lactic and acetic acids, which prevent further development of the organism. When the alkaline juice flows through pipes (and cannot therefore become acidified), the organism multiplies so rapidly that the pipes may be choked with the gelatinous dextran-deposit. The surest remedy is to heat the juice to 100° C. before adding lime, thereby killing the organisms.

A very similar gum, levan, $C_6H_{10}O_6$, is produced by *Bacillus levaniformans*. On hydrolysis with acid, levan yields levulose (fructose). Levan is soluble in water, and resembles gum arabic.

(4) *Cane Wax, Cane Fibre, and Starch.*—These being insoluble in the juice, are removed along with those substances precipitated by lime. Cane wax, $C_{24}H_{50}O$, occurs as a whitish deposit on the exterior surface of the cane stem, close to each node. The wax is insoluble in cold water and alcohol, but soluble in hot alcohol, chloroform, ether, and benzene. It melts at $82^{\circ}C$., and boils at $146^{\circ}C$. (Geerligs). The wax can be extracted from “filter-press cake” by means of benzene, and this has been carried out successfully in Natal (see p. 355).

Cane fibre is not completely separated from the juice by the mechanical strainers at the mill, nor is this desirable, because the presence of fibre in the “filter-press cake” greatly facilitates filtration (see p. 206). Of the total dry organic matter separated from the juice during filtration, about 20% by weight consists of fibre.

Starch occurs in the leaves and uppermost joints of the cane, but is absent in the mature joints.

MINERAL MATTERS

These are all derived from the soil, and constitute the incombustible ash of the plant. The total quantity does not exceed 1% by weight of the entire cane plant, proving that the sugar-cane removes less mineral matter from the soil than many other crops. The following mineral substances are essential to plants:—potassium, phosphorus, calcium, and iron, and these may be regarded as indispensable “plant-foods.” Nitrogen is also an important plant-food, and is derived from the soil, as stated previously.

The quantity and nature of the mineral matter in the cane naturally depends on the nature of the soil, but different varieties of cane, grown on the same soil, show differences in this respect. The mineral matters in the stem are partly in solution, as constituents of the juice; and partly in an insoluble form, associated with the solid structure of the plant. The mineral constituents of the juice are objectionable impurities, since they hinder crystallisation of the sugar, and thus tend to produce molasses.

DISTRIBUTION OF THE CONSTITUENTS IN THE CANE STEM

As the cane-stem ripens from below upwards, the juices extracted from the upper and lower joints of the same stem, differ in composition. The uppermost, green joints contain scarcely any sugar, but some starch; the latter being transformed into fibre during the growth of these joints. A little lower down are joints bearing young leaves, and in which sugar is being stored, chiefly glucose and fructose; the starch having here been consumed in the formation of fibre. Still lower down, are joints bearing fully developed leaves, in which sugar-production is very active. Here, sucrose begins to accumulate in the stem, while the reducing sugars (also formed) ascend to the upper joints and leaves, and are there transformed into fibre.

Hence, as each joint approaches maturity, it contains an increasing percentage of sucrose, and a decreasing percentage of reducing sugars. Still lower on the stem, are the fully mature joints whose leaves have withered. This portion receives sucrose from the higher joints, in exchange for reducing sugars, which continue to ascend towards the growing joints; so that the reducing sugars disappear almost completely, and the percentage of sucrose reaches its maximum, and does not increase further during the ripening of the upper joints of the stem. Finally, in those joints to which the roots are attached, sucrose is inverted, in order to supply reducing sugars to the growing roots; these sugars being transformed into fibre or root-structure. The sweetest joints of the stem are therefore those just above the ground level.

The juice extracted from a single cane-stem must therefore be a mixture of the juices contained in its numerous joints, which explains the invariable presence of reducing sugars. The organic acids, nitrogen compounds, gums, and mineral matters are more abundant in the uppermost joints; gradually diminishing to the minimum percentages in the fully ripe, lower joints. The leaves contain more mineral matter than any other portion of the plant. In overripe

cane, a part of the sucrose becomes inverted in the lower joints, and the maximum sucrose-content is then found towards the middle of the stem, diminishing downwards towards the ground, while the percentage of reducing sugars simultaneously increases.

The lower joints contain more fibre than the middle and upper joints; and, in any single joint, the node and rind of the internode contain much more fibre than the internal parenchyma, or pith. Similarly, the fibro-vascular-bundles, passing through the pith, contain more fibre than the pith itself.

CHAPTER XIV

COMPOSITION OF THE BEET, AND EXTRACTED JUICE

THE root contains about 80% of water, in which sucrose and various non-sugars are dissolved, forming about 95.5% by weight of juice. The remaining 4.5 to 5.0% represents the insoluble matter, or "marc" of the root; and consists of cellulose, and other carbohydrates. The percentage composition of the root is variable; the average being as follows:—

		<i>Sucrose % in 1912-13.</i>
Water	78.0	Germany 16.5
Sucrose	15.0	U.S. America 16.3
Organic non-sugars	1.5	Holland 15.9
Mineral matters	1.0	Austria-Hungary 15.2
Fibre and insoluble matters	4.5	Belgium 15.2
	<hr style="width: 100%;"/>	France 14.6
	<u>100.0</u>	Russia 13.4
	<hr style="width: 100%;"/>	Italy 12.7
		<hr style="width: 100%;"/>
		Mean = <u>15.0</u>

The variations in sucrose percentage, in different countries, are also shown. In addition to sucrose, the root contains from 0.04 to 0.50% of reducing sugars (glucose and fructose); also from 0.01 to 0.02% of raffinose.

The diffusion juice is a water-extract of the more diffusible constituents (crystalloids) of the natural, or true juice; and forms an opaque, grey, or yellowish liquid, of specific gravity 1.048 to 1.063 (12° to 15° Brix), which rapidly darkens on exposure to the atmosphere. Its percentage composition falls within the following limits:—

Water	85 to 88	} dissolved solid matters or "Brix" = 12.0 to 15.0.
Sucrose	10 ,, 14	
Organic non-sugars	0.4 ,, 1.7	
Mineral matters	0.3 ,, 0.6	

The properties of the sugars were described in Chapter XII, and the non-sugars are classified in Table IV.

TABLE IV.—NON-SUGARS IN BEET JUICE

Acids.	Nitrogen Compounds.	Colouring Matters.	Other Organic Non-sugars.	Mineral Matters.
<p><i>Organic Acids.</i> aconitic citric glycolic malic oxalic succinic tartaric</p>	<p><i>Organic Compounds.</i> albuminoids acid amides amino-acids peptones xanthene-compounds</p>	<p>condensation products of amino-acids and reducing sugars</p> <p>Ferric compounds of catechol</p>	<p>catechol cholesterol glucosides pectins pentosans lecithin</p>	<p>alumina iron oxide lime magnesia potash soda chlorine</p>
<p><i>Inorganic Acids.</i> phosphoric sulphuric silicic</p>	<p><i>Inorganic Compounds.</i> of ammonia and nitric acid</p>		<p><i>Insoluble.</i> pectose</p>	

ACIDS

The juice has an acidity equal to about 2 c.c. of normal acid per 100 c.c., mainly due to oxalic acid. The numerous acids shown in the table are mainly combined with the mineral bases (column 5), forming neutral or acid salts. After the juice has been limed, the lime-salts of oxalic and phosphoric acids separate in the form of "scale" on the metal heating-tubes of the multiple-effect evaporator, as described in the previous chapter (p. 129). In addition to the acids mentioned above, lactic, glucinic, and others may be formed by the action of lime and heat on the reducing sugars (see p. 117).

NITROGEN COMPOUNDS

The root contains about 0.2% of total nitrogen, occurring in the following forms, according to Urbain's analyses:—

	<i>Per cent. of Beet.</i>	<i>Per cent. of total Nitrogen.</i>
Albuminoid nitrogen	0·063	= 31·82
Amide and ammonium compounds	0·069	= 34·85
Nitrogen as nitrates	0·050	= 25·25
„ „ insoluble proteids	0·012	= 6·06
Other forms of nitrogen	0·004	= 2·02
Total Nitrogen =	0·198	= 100·0

During dialysis, or diffusion, the non-diffusible albuminoids remain in the cells of the beet slices, after the sucrose has been extracted. But, as a great many cells are cut open during the slicing operation (see p. 93), the total contents of these cells pass into the juice without any dialysis, thus lowering its purity. The subsequent chemical treatment of the juice coagulates this albumin, so that it is separated along with the precipitated non-sugars, by filtration.

When the juice is rendered alkaline with lime, and boiled, it evolves ammonia, owing to the decomposition of ammonium compounds, and hydration of amides. The other nitrogen compounds (especially nitrates), remain unchanged; and, as they retard the subsequent crystallisation of the sucrose, are termed "objectionable nitrogen." This increases during factory operations, as shown in the following analyses by Duschley:—

	Diffusion Juice.	After First Carbonation.	After Third Carbonation.	Syrup.
Albuminoid nitrogen	23·8	4·6	1·7	1·6
Amide and ammonium compounds	10·7	12·4	7·3	1·1
Objectionable nitrogen.	65·5	83·0	91·0	97·3
	100·0	100·0	100·0	100·0

The amino-acids give rise to colouring matters, as explained under the following heading.

COLOURING MATTERS

The sugar-beet differs from the garden-beet in having a colourless sap or juice, but this darkens rapidly on exposure to the atmosphere, becoming almost black in a very short

time. The cause of this darkening has been studied by numerous chemists, with the results given below.

Nitrogen Compounds.—Maillard and Lafar have shown that the amino-acids (glutamic and aspartic), also asparagin, combine with reducing-sugars, forming dark-coloured condensation-products, which they term "melanoïdins"; and which account for 50% of the colour of beet syrup. Further investigations by Oudemans proved that these dark compounds are formed in neutral as well as in acid juices and syrups. The colouring matter is insoluble in alcohol, and is precipitated by basic lead acetate. In duplicate experiments, but omitting the amino-acid, very little colour was produced, and this was free from nitrogen, and soluble in alcohol. The intensity of the nitrogenous colouring matter relative to the non-nitrogenous colouring matter (in the "blank experiments") was as follows:—Aspartic acid = 4 times; asparagin = $2\frac{1}{2}$ times; and glutamic acid = one-third. He therefore attributes the nitrogenous colouring matter to condensation-products of reducing-sugars with asparagin and aspartic acid.

Catechol.—This polyphenol has been detected in beet juice by Gonnermann and Grafe, who attribute the darkening of the juice, on exposure to the atmosphere, to oxidation of ferrous salts (also present in the juice) with the formation of black ferric-compounds of catechol, the latter substance being formed by the action of enzymes on tyrosin. The harmful effect of ferric salts in the manufacture of white sugar was explained under the heading "tannins" in cane juice (p. 131). As this type of colouring matter is almost entirely eliminated in the beet-sugar factory during "carbonation" of the juice, it does not account for the dark colour of syrup derived from the "carbonated juice."

Decomposition Products.—Although the juice extracted from normal beets contains only traces of glucose and fructose, these sugars may be formed by inversion of sucrose (p. 110), and yield dark-coloured products (glucinic acid, etc.) by the action of lime and heat, as in the case of cane juice (p. 133).

Overheating of the syrup during concentration to massecuite may cause darkening, by the formation of caramel.

OTHER ORGANIC NON-SUGARS

Pectose is present in beets, turnips, and similar roots; also in most unripe fruits. It is insoluble in water, and closely allied to cellulose. On heating with dilute acids or alkalis, pectose is converted into pectin, pectic acid, metapectic acid, and pectosic acid, which are soluble compounds, of a gelatinous nature. The properties of pectin were described in the previous chapter (p. 133). As pectins possess the properties of colloids, they are only partially extracted from the beet during diffusion, and are almost completely separated from the juice during the subsequent purification by "carbonation."

Two wax-like compounds—*cholesterol* and *lecithin* (the latter containing nitrogen and phosphorus)—are found in the juice, but are of no special interest in the manufacture of sugar.

MINERAL MATTERS

The mineral non-sugars of beet juice (Table IV) are the same as those of cane juice (Table III, p. 128). The gradual improvement of the sugar-beet is evident from the fact that, in 1874, the complete plant removed from the soil 14 parts of mineral matters per 100 parts of sucrose formed in the root; whereas, to-day, the plant removes only 8 parts of mineral matters per 100 parts of sucrose formed. The modern beet is therefore not only richer in sucrose, but the juice contains less saline impurities, so that a larger percentage of the contained sucrose can be extracted in the form of crystals.

The mineral matters predominate in the leaves and in the upper portion, or "crown" of the root. The "topped" roots, sent to the factory, contain only 0.8% of mineral matters; potash being the chief constituent. These mineral bases are combined with the various organic and inorganic acids of the juice, forming soluble salts. Chlorides and sulphates of the alkalis are termed "objectionable saline impurities," because they prevent crystallisation of part of the sucrose, thereby increasing the yield of molasses.

EXTRACTION OF NON-SUGARS DURING DIFFUSION

The foregoing constituents of the sugar-beet are only partially extracted, along with the sucrose, during diffusion ; the following figures are given by Andrlík :—

		Percentages of each Constituent extracted during Diffusion.
Sucrose		96 to 98%
Total mineral matters		66 ,, 71%
including {	Potash	76 ,, 83%
{	Soda	78 ,, 81%
{	Sulphuric acid	61 ,, 77%
{	Chlorine	84 ,, 92%
Albuminoids		15 ,, 23%
“Objectionable” nitrogen compounds		87 ,, 95%
Non-albuminoids		92%

He remarks that diffusion juice is purer than the true juice of the beet, because the sucrose diffuses more completely than the saline impurities and the “ objectionable ” nitrogen compounds, as shown above.

CHAPTER XV

INFORMATION OBTAINED BY ANALYSIS

IN order to extract the maximum quantity of sugar from the cane and beet, it is necessary to analyse these raw materials entering the factory, the commercial sugars produced, and the various by-products obtained ; thus indicating the losses of sucrose at different stages of manufacture.

Such "chemical control" of the factory is an essential feature of modern practice, but the subject lies beyond the scope of this work.¹ It will be sufficient to explain the principles which underlie the methods of analysis, the methods of stating the results, and the practical information they yield.

SUCROSE % IN THE BEET

The root is reduced to a fine pulp by means of a rasping-machine, and a weighed quantity of pulp is treated with cold water, hot water, or alcohol. The resulting extract is clarified, the optical rotation (or "*polarisation*") measured in the polariscope, and the sucrose, thus found, is calculated to 100 parts of the beet pulp. As a factory treats hundreds of tons of roots per day, the average sucrose % is found by analysing hourly samples of sliced beet (as it enters the diffusion battery), and adopting the mean result of the separate analyses.

SUCROSE % IN CANE

It being impossible to obtain an average sample of uncrushed cane sufficiently small for direct analysis, it is necessary to calculate the sucrose % from the percentages

¹ A list of books dealing with chemical-control is given on p. 329.

found in the two mill-products—juice and bagasse; both of which can be accurately sampled.

$$\text{Sucrose \% in cane} = \frac{\left\{ \frac{\text{Sucrose \% in juice} \times \text{juice per 100 cane}}{100} + \frac{\text{Sucrose \% in bagasse} \times \text{bagasse per 100 cane}}{100} \right\}}{100}$$

ANALYSIS OF THE JUICE.

The following values are determined:—specific gravity; total dissolved solid matters; and the individual percentages of sucrose, reducing sugars, and mineral matters (or ash).

(1) *Specific Gravity* is usually measured by the Brix Saccharometer (p. 106); and the specific gravity, corresponding to the observed degrees-Brix, is ascertained from published Tables.

(2) *Total dissolved Solid Matters*.—A known weight of juice is mixed with a known weight of sand or crushed pumice-stone, and heated until the water is completely evaporated, the dry solid residue is weighed, and the weight of added sand or pumice-stone deducted. As this test occupies three or four hours, the following more rapid methods are employed.

By assuming that equal weights of dissolved sucrose and non-sugars produce equal effects on the density (Brix), and also on the refractive index of the juice, either of these values would indicate *sucrose plus non-sugars*, or total dissolved solids. As the assumption made is not quite true, the degrees-Brix are termed *apparent dry solids%*, or *density-solids%*, or *Brix-solids%*. When adopting the refractive-index, instead of the Brix, the corresponding sucrose% (from published Tables) is also termed *apparent dry solids%*, or *refraction-solids*, or *optical-solids*.

(3) *Sucrose%*.—This constituent of the *total dry solids* is determined by the optical rotation of the juice, as measured in the polariscope, or saccharimeter. But cane and beet juices contain substances other than sucrose, which act on polarised light; for example, glucose and fructose. The optical rotation, or *direct polarisation* of the juice is, therefore, not an exact measure of the sucrose, and is termed the

apparent sucrose %. On heating the juice with an acid, the sucrose becomes completely inverted (see p. 110), and the change in optical rotation, before and after this inversion, enables the *true sucrose* % to be calculated.

When the other optically active substances are present in very small proportions (relative to sucrose), the *direct polarisation* closely corresponds to the *true sucrose* %, calculated as above; and agrees exactly, when sucrose is the only optically active substance in the juice.

(4) *Reducing Sugars*.—A measured volume of Barreswil's (Fehling's) Solution (see p. 119) is diluted with water and boiled. The juice is then gradually added until the whole of the copper is precipitated as cuprous oxide. From the volume of juice thus added, the reducing sugars per 100 of juice can be calculated. Although both glucose and fructose may be present, the total percentage is so small that it is customary to record this total percentage as *glucose* in the cane-sugar factory. Beet juice contains only traces of glucose and fructose, together with other reducing substances, such as asparagin, aspartic, and glutamic acids, and their salts. Hence, in the beet-sugar factory, it is more correct to speak of *reducing substances*, than *reducing sugars*.

(5) *Mineral Matters, or "Ash."*—A weighed portion of juice is evaporated to dryness, and the residue ignited, first gently, and finally at a red-heat, until all carbonaceous matter is burnt. The residual ash can then be weighed.

(6) *Organic Non-sugars*.—These cannot be directly determined, but are estimated indirectly, by deducting the percentages of sucrose, reducing sugars, and mineral matters, from the percentage of *total dissolved solids*.

The application of the chemist's analyses to the large-scale operations in the factory, is illustrated in the following scheme.

METHODS USED IN CONTROLLING THE MILL WORK

Factory Data—

- | | | |
|---|-----------------------|---|
| A | Tons of cane crushed. | By weighing in trucks or carts |
| B | „ saturation water. | By automatic weighers, or calculated from volume in measuring tanks |
| C | „ juice extracted. | By automatic Juice-weighers, or calculated from volume and density in measuring tanks |

Analytical Data—

- D Sucrose % in mixed extracted juice from all mill-units
- E " " undiluted juice extracted by Crusher and first unit
- F " " bagasse leaving last unit
- G Fibre % in " " "

Calculated Results—

H	Tons of bagasse leaving last unit	= A + B -
I	" fibre crushed	= $\frac{H \times G}{100}$
J	" sucrose extracted	= $\frac{C \times D}{100}$
K	" sucrose lost in bagasse	= $\frac{H \times F}{100}$
L	" sucrose in canes entering mill	= J + K
M	" juice " " "	= A - I
N	Sucrose % " " "	= $\frac{L \times 100}{A}$
O	Fibre % " " "	= $\frac{I \times 100}{A}$
P	Sucrose lost in bagasse per 100 of cane	= $\frac{K \times 100}{A}$
Q	" Loss Quotient	= $\frac{P \times 100}{N}$
R	" extracted per cent. sucrose in cane (Extraction) =	$\frac{J \times 100}{L}$
S	Unextracted juice per 100 fibre leaving mill } Lely's Formula (see p. 58) }	= $\frac{F \times 100}{E} \times 100$
T	Unextracted sucrose per 100 fibre leaving mill	= $\frac{F \times 100}{G}$
U	Saturation water per cent. on cane crushed	= $\frac{B \times 100}{A}$
V	" " " " fibre "	= $\frac{B \times 100}{I}$
W	" "Mill Performance"—Lely's Formula (see p. 60)	= $\frac{Q \times V}{125} \div 6$

From the analysis of the extracted juice, additional information is obtained by calculating the following ratios:—

(a) *Purity*, or *Quotient of Purity*, or *Sucrose Quotient*

$$= \frac{\text{Sucrose \%} \times 100}{\text{dry solids \%}}$$

Thus, a solution containing 10% of sucrose, and no other dissolved solids, has a sucrose % of 10.0, and a purity of 100. Cane and beet juices rarely exceed 90% purity, since they contain about 10 parts of non-sugars in 100 parts of total dry solids. It is obvious that this *Purity* is not modified by

the addition of water to the juice, as in wet-crushing, and diffusion, nor by the abstraction of water by evaporation. Consequently, any change in this ratio during chemical treatment of the juice, and concentration to syrup, indicates either destruction of sucrose (= fall in purity), or precipitation of non-sugars (= rise in purity).

For certain purposes, it is sufficient to measure the *apparent purity* of juices, syrup, etc., as indicated in (2) and (3) below :—

- | | | |
|---|--|-------------------|
| (1) True Purity | $= \frac{\text{True Sucrose \%} \times 100}{\text{dry solids \%}}$ | = standard method |
| (2) Apparent Purity
or <i>Optical Purity</i> | $= \frac{\text{Direct Polarisation} \times 100}{\text{Solids \% by refractive index}}$ | } rapid methods. |
| (3) Apparent Purity
or <i>Density Purity</i> | $= \frac{\text{Direct Polarisation} \times 100}{\text{Solids \% by Brix hydrometer}}$ | |

The accuracy of the three methods is in the order given.

The purity of syrup and molasses is determined in the same manner as for juice, after diluting with water to about the same density as the juice.

The purity of sugar crystals is calculated as follows. Dry solids % = 100 — moisture %; and purity = $\frac{\text{sucrose \%} \times 100}{\text{dry solids \%}}$

RATIOS USED IN THE CANE-SUGAR FACTORY

The percentage composition of the dry solids of juices, syrups, etc., is expressed by the following three terms:—

(a) *Sucrose Quotient* (see above); (b) *Glucose Quotient*; and (c) *Impurity Quotient*.

(b) *Glucose Quotient*

$$= \frac{\text{glucose \%} \times 100}{\text{dry solids \%}}, \text{ or, more usually}$$

$$= \frac{\text{glucose \%} \times 100}{\text{solids \% by Brix hydrometer}}.$$

(c) *Impurity Quotient*

$$= 100 - (\text{Sucrose Quotient} + \text{Glucose Quotient}).$$

These three Quotients are illustrated in the following example. A sample of cane juice gave the following analytical results:—17.0% dry solids, 14.45% sucrose, and 1.53% glucose (total reducing sugars).

$$\text{Then Sucrose Quotient} = \frac{14.45 \times 100}{17} = 85.0$$

$$\text{Glucose Quotient} = \frac{1.53 \times 100}{17} = 9.0$$

$$\text{Impurity Quotient} = 100 - (85 + 9) = 6.0$$

$$\text{Total dry solids} = 100.0$$

Let the symbols B, S, and P, represent Brix (dry solids), Sucrose, and Purity, respectively; then the following relations are found, and are illustrated by the same example:—

$$B = \frac{100 S}{P} \quad \text{or} \quad \frac{100 \times 14.42}{85} = 17.0$$

$$S = \frac{B \times P}{100} \quad \text{or} \quad \frac{17 \times 85}{100} = 14.45$$

$$P = \frac{100 S}{B} \quad \text{or} \quad \frac{100 \times 14.45}{17} = 85.0.$$

The Quotients are of especial interest in the following analyses of the juices extracted by the separate units of an eleven-roller mill. No saturation water was added whilst the samples were collected, thus avoiding any dilution of the juices.

TABLE V.—COMPOSITION OF CANE JUICE EXTRACTED BY “DRY CRUSHING”

	Analytical Data, or percentages on Juice.			Calculated Quotients, or percentages on total Dry Solids in Juice.		
	Brix	Sucrose	Glucose	Sucrose	Glucose	Impurity
Crusher . .	19.85	16.86	2.36	84.94	11.89	3.17
First unit .	19.55	16.40	2.09	83.89	10.70	5.41
Second unit .	19.43	16.01	2.09	82.38	10.75	6.87
Third unit .	19.24	15.81	1.91	82.15	9.91	7.94

The *Sucrose Quotient*, or Purity, decreases from 84.94 in Crusher-juice, to 82.15 in juice from third mill-unit, or 2.79 units. The *Impurity Quotient* rises from 3.17 in Crusher-juice, to 7.94 in juice from third mill-unit, or 4.77 units.

The slight differences found by direct analysis are thus magnified in the calculated Quotients.

(d) *Glucose Ratio to Sucrose, or Glucose Coefficient*

$$= \frac{\text{Glucose \%} \times 100}{\text{Sucrose \%}}$$

This ratio serves for detecting inversion of sucrose during the subsequent operations; since any decomposition of sucrose is attended by an increase in reducing-sugars (measured as glucose). The ratio can only prove inversion if there has been no decomposition of reducing-sugars also, as indicated by the following ratio:—

(e) *Glucose Ratio to Ash* = $\frac{\text{Glucose \%}}{\text{Ash \%}}$.

(f) *Dilution of Extracted Juice.*—Part of the saturation water, added between the mill-units, passes into the extracted juice, the balance remaining in the bagasse leaving the last mill-unit. If hot water be used, an unknown quantity is lost by evaporation during milling. That portion of the added water which passes into the juice, reduces its density to that of the total extracted juice, and must be evaporated from this total juice in order to leave 100 parts of normal, or true juice.

Let B_1 = Brix of undiluted juice (extracted by first mill-unit)
 ,, B_2 = ,, ,, diluted juice (extracted by all the units together)
 Then $\frac{100(B_1 - B_2)}{B_2}$ = dilution % on normal, or true juice.

Ratios (d) and (e) are illustrated in the following Table, taken from Geerligs' *Cane Sugar and its Manufacture* (p. 121).

In this case, the decrease in *Sucrose Quotient*, or *Purity*, from first mill to third mill, is $84.18 - 77.39 = 6.79$ units; and the increase in *Impurity Quotient* is $14.19 - 5.79 = 8.40$ units. The analytical figures show that the heavier pressures in the second and third units extract increasing proportions of mineral matters, albuminoids, and gums from the harder portions of the cane. The *Glucose ratio to Sucrose* is fairly uniform in the three mill juices, but the *Glucose ratio to Ash* rapidly decreases from 4.16 to 1.60. On comparing the

TABLE VI.—ORGANIC AND MINERAL NON-SUGARS EXTRACTED BY SEPARATE UNITS OF A MULTIPLE MILL

	Analytical Data, or percentages on Juice.		
	1st Mill.	2nd Mill.	3rd Mill.
Brix	15·36	14·60	14·60
Sucrose	12·93	11·41	11·30
Reducing Sugars (Glucose)	1·54	1·29	1·23
Ash (Mineral Matters)	0·37	0·58	0·77
Albuminoids	0·18	0·50	0·58
Free Acid	0·10	0·11	0·14
Combined Acid	0·14	0·15	0·12
Gums	0·10	0·56	0·51
	Calculated Data		
Sucrose Quotient	84·18	78·15	77·39
Glucose Quotient	10·03	8·84	8·42
Impurity Quotient	5·79	13·01	14·19
Glucose ratio to Sucrose	11·91	11·30	10·88
„ „ „ Ash	4·16	2·22	1·60

Brix and sucrose % in Tables V and VI, it will be seen how greatly the composition of the juice varies.

(g) *Indicated Sucrose in the Juice.*—By weighing or measuring the whole of the extracted juice obtained in each shift of 12 hours, and by analysing an average sample, a simple calculation gives the tons of sucrose extracted by the mill (or by the diffusion battery), during these periods (see “J” on p. 147). The result is termed tons of *Indicated Sucrose in Juice*.

Only a certain percentage of this can be converted into crystals, the remainder being uncrystallisable, and left in the molasses. The crystallisable portion is termed *Available Sucrose*, and may be calculated as follows:—

(h) *Available Sucrose* (Deerr’s formula).—

Case (a).—In the White Sugar Factory

Let a unit weight of juice-solids contain S parts of sucrose of which C parts can be extracted in the form of crystals.

Then, “Available Sucrose” = $\frac{C}{S}$ per unit of sucrose in the juice
 or $\frac{100 C}{S}$ % „ „ „ „

There remains a residue of $1 - C$, representing the dry solids in the molasses separated from the crystals. Let this material contain M parts of uncrystallisable sucrose per unit weight.

$$\begin{aligned} \text{Then, } S &= C + (1 - C)M & \text{or } C &= \frac{S - M}{1 - M} \\ \text{and Available Sucrose} &= \frac{C}{S} = \frac{S - M}{S(1 - M)} & \text{per unit of sucrose in juice} \\ & & \text{or } \frac{100(S - M)}{S(1 - M)} \% & \text{ " " " " } \end{aligned}$$

Now, S and M are the purities of juice and molasses, respectively, expressed per unit; and the available sucrose is proportional to the difference between these two purities. Molasses is said to be "exhausted," or uncrystallisable, when no more crystals are obtained by evaporation of water, followed by cooling; and the quantity of dissolved sucrose (M) depends on the nature of the non-sugars also present, and therefore, on the composition of the juice from which the molasses was derived. In any given factory, the composition of the molasses is fairly constant from year to year; whereas, the purity of the juice fluctuates considerably, and is therefore the principal factor in fixing the percentage of *Available Sucrose* in the juice, or syrup.

Case (b).—In the Raw Sugar Factory

Here, the extracted sugar crystals are moist, and contain varying proportions of non-sugars; so that the previous argument requires to be modified as follows.

Let a unit weight of juice-solids contain S parts of sucrose, as before. During factory operations, C parts of sucrose, and N parts of non-sugars are extracted in the form of raw sugar crystals, containing R parts of sucrose per unit weight.

There remains a residue of $1 - (C + N)$, representing dry solid matters left in the molasses. Let this contain M parts of uncrystallisable sucrose per unit weight.

$$\text{Then, } S = (C + N)R + (1 - C - N)M \quad \text{or } C + N = \frac{S - M}{R - M}$$

$$\left. \begin{array}{l} \text{and the dry matter} \\ \text{extracted as crystals,} \\ \text{per unit sucrose in} \\ \text{juice} \end{array} \right\} = \frac{C + N}{S} = \frac{S - M}{S(R - M)}$$

On comparing this with the previous equation, it is seen that R (= purity of raw sugar crystals) is substituted for unity (= pure sucrose in white sugar).

As C + N represents dry matter in the raw sugar crystals, the equivalent yield of moist raw sugar will be :—

$$\left. \begin{array}{l} \text{Available moist raw sugar} \\ \text{per unit of sucrose in juice} \end{array} \right\} = \frac{S - M}{S(R - M)} \times \frac{100}{\text{Dry solids in sugar}}$$

Cases (a) and (b) are illustrated in the following examples :—

$$\begin{array}{l} \text{Purity of juice} = 85.0\% = 0.85 \text{ per unit} \\ \text{,, ,, molasses} = 42.0\% = 0.42 \text{ ,, ,,} \end{array}$$

Then, in case (a), where the extracted crystals are dry and almost pure :—

$$\begin{aligned} \text{Available Sucrose} &= \frac{0.85 - 0.42}{0.85(1.0 - 0.42)} = 0.872 \text{ per unit of sucrose in juice} \\ &= 87.2\% \text{ of sucrose in juice.} \end{aligned}$$

In case (b), let the raw sugar crystals have the following composition :—

Sucrose 96.8%, water 1.0%. Then, dry solids = 99.0%, and purity = $\frac{96.8 \times 100}{99} = 97.8\%$, or 0.978 per unit.

$$\begin{aligned} \text{Available moist raw sugar} &= \frac{0.85 - 0.42}{0.85(0.978 - 0.42)} \times \frac{100}{99} \\ &= 0.915 \text{ per unit of sucrose in juice} \\ &= 91.5\% \text{ of sucrose in juice.} \end{aligned}$$

The above difference in yields of white and raw sugars from the same juice may be confirmed by the following considerations. The dry solid matters of the molasses consist of 42 parts of uncrystallisable sucrose united to 58 parts of non-sugars; or 1.38 parts of non-sugars prevent 1 part of sucrose from crystallising. The moist raw sugar contains 99% dry solids, and 96.8% sucrose; which leaves 2.2% of non-sugars. The latter proportion can prevent the crystallisation of $\frac{2.2}{1.38} = 1.6$ parts of sucrose; therefore :—

$$\begin{array}{l} \text{Crystallisable sucrose present in 100 parts raw sugar} = 96.8 - 1.6 = 95.2 \\ \text{,, ,, ,, ,, 91.5 ,, ,, ,,} = \frac{91.5 \times 95.2}{100} = 87.2. \end{array}$$

The last result corresponds with the available white sugar in case (a).

The calculation of "available sucrose," or "available raw sugar," serves as a useful check on the actual yields obtained

in the factory. The application of this formula will be more fully discussed in Chapter XXVII (pp. 326-329).

RATIOS USED IN THE BEET-SUGAR FACTORY

Let A = Ash %. B = Brix (dry solids %). S = Sucrose %.
P = Purity %.

Then B - S = total non-sugars %; and B - S - A = organic non-sugars %

$$(a) \text{ Quotient Saline} = \frac{\text{Sucrose \%}}{\text{Ash \%}} = \frac{S}{A} = Q$$

$$(b) \text{ Ratio Organic} = \frac{\text{organic non-sugars \%}}{\text{Ash \%}} = \frac{B - S - A}{A} = R$$

$$\therefore R + 1 = \frac{B - S}{A} \text{ or ratio of ash to total non-sugars}$$

$$(c) \text{ Quotient Impurity} = \frac{\text{total non-sugars \%} \times 100}{\text{Sucrose \%}} = \frac{100(B - S)}{S}$$

$$(d) \text{ Quotient Inorganic} = \frac{\text{Ash \%} \times 100}{\text{Sucrose \%}} = \frac{100 A}{S}$$

$$(e) \text{ Quotient Organic} = \frac{\text{organic non-sugars \%} \times 100}{\text{Sucrose \%}} = \frac{100(B - S - A)}{S}$$

The above three quotients, being based on 100 parts of Sucrose, differ from the *Impurity* and *Glucose Quotients* used in the cane-sugar factory, which are based on 100 parts of Brix (or dry solids).

Relation between Brix, Sucrose %, and Purity.—As for cane juice (see p. 149).

Relation between Sucrose %, Ash %, and Quotient Saline.—

$$\text{Sucrose \%} = S = QA$$

$$\text{Ash \%} = A = \frac{S}{Q}$$

$$\text{Quotient Saline} = Q = \frac{S}{A}$$

Relation between Purity, Quotient Saline, and Ratio Organic.—

$$\text{Purity} = P = \frac{100 Q}{Q + (R + 1)} = \frac{\frac{100 S}{A}}{\frac{S}{A} + \frac{(B - S)P}{A}} = \frac{100 S}{S + (B - S)P}$$

$$\text{Quotient Saline} = Q = \frac{(R + 1)P}{100 - P} = \frac{\frac{(B - S)P}{A}}{\frac{(B - S)100}{B}} = \frac{PB}{100 A} = \frac{S}{A}$$

$$\text{Ratio Organic} = R = \frac{Q(100 - P)}{P} - 1 = \frac{\frac{S}{A} \times \frac{(B - S)100}{B}}{P} - 1 = \frac{\frac{B - S}{A} \times P}{P} - 1 = \frac{B - S - A}{A}$$

Relation between Quotient Impurity, Quotient Inorganic, and Quotient Organic:—

$$\begin{aligned} \text{Quotient Impurity} &= \text{Quotient Inorganic} + \text{Quotient Organic} \\ \text{or } \frac{100(B - S)}{S} &= \frac{100A}{S} + \frac{100(B - S - A)}{S} \end{aligned}$$

Relation between Quotient Impurity and Purity:—

$$\text{Quotient Impurity} = \frac{100(100 - P)}{P} = \frac{100 \left(\frac{(B - S)100}{B} \right)}{\frac{100S}{B}} = \frac{100(B - S)}{S}$$

Relation between Quotient Inorganic and Quotient Saline:—

$$\text{Quotient Inorganic} = \frac{100}{Q} = \frac{100}{\frac{S}{A}} = \frac{100A}{S}$$

Numerous applications of the foregoing formulæ to problems in the beet-sugar factory will be found in *Vade-Mecum de Sucrierie*—Pellet et Métillon; published by “La Sucrierie Indigène et Coloniale,” 143 Boulevard Magenta, Paris.



PART V

TREATMENT OF CANE AND BEET JUICES

- CHAPTER 16. CHEMICAL AGENTS USED, AND METHODS OF HEATING THE JUICE
- „ 17. CHEMICAL TREATMENT OF CANE JUICE
- „ 18. SEPARATION OF THE PRECIPITATE
- „ 19. CHEMICAL TREATMENT OF BEET JUICE



CHAPTER XVI

CHEMICAL AGENTS USED, AND METHODS OF HEATING THE JUICE

HISTORICAL

THE earliest records of sugar manufacture relate to the sugar-cane, and the primitive methods of purifying the juice do not differ essentially from the practice of to-day. The juice, extracted from the cane in crude mills, was heated in an iron vessel over a wood-fire. The ashes from the fire were added to the hot juice, from time to time, causing a dark-coloured scum to rise to the surface, and which was removed by skimming. The juice, thus purified, was heated to boiling point, concentrated to a thick syrup at a high temperature, and allowed to cool slowly. The final result was a crystallised mass, consisting of sucrose crystals mixed with various non-sugars, not previously separated by skimming. This process is still employed in China and India, the Indian product being termed jaggery, or ghur.

The treatment with wood-ashes was supplemented by the addition of certain plant-extracts; yet, at this early period, chemical science was unknown, and practical experience was the only guide. The mysterious "art of sugar-boiling" was acquired with great difficulty, and the secret handed down from father to son, for many generations. The "sugar expert," in those days, was generally a negro slave.

The chemical action of wood-ashes is now easily explained by the alkaline constituent—potassium carbonate—which precipitates certain non-sugars in the juice, producing the dark-coloured scum mentioned above. The chemical action of the plant-extracts would, no doubt, be as easily explained, if the names of these plants had been recorded.

When sugar manufacture developed on a larger scale, more economical methods of heating the juice were adopted. A series of vessels, or "taches," were built into the top of a long flue, having a wood-fire at one extremity, and a chimney at the other. This arrangement, called a "copper-wall," is still used in certain countries. The "taches" are made of copper, or of iron, and heated by the hot gases passing through the flue. The juice enters the copper farthest from the furnace; and, as evaporation proceeds, is transferred from copper to copper, by means of ladles; finally reaching the copper nearest the furnace, and attaining its maximum temperature and density. The chemical treatment is effected during the preliminary evaporation in the first three coppers; formerly, by the addition of wood-ashes and plant-extracts, followed by skimming. Steam-heating was first employed in 1785.

Other alkalis soon came into use; namely, carbonate of soda, which is used in India at the present day; and the cheaper alkali—quicklime, first employed in addition to wood-ashes, about the year 1750, and finally substituted for the latter, when its advantages had been proved. Lime has remained in use to the present day, as the purifying agent for cane and beet juices.

In the modern factory, the object of chemical treatment is threefold, namely:—

(1) *Purification*, or the precipitation of dissolved non-sugars from the juice; thereby increasing its purity, and, consequently, increasing the percentage of *available*, or crystallisable sucrose (p. 151).

(2) *Clarification*, or the separation of insoluble solid matters suspended in the juice, which render it opaque, and dark in colour. These impurities cannot be separated by simple filtration of the raw juice, but are separated along with the non-sugars precipitated by lime and heat, leaving the juice transparent.

(3) *Bleaching*.—This treatment is only adopted in the manufacture of white and yellow sugars, intended for direct consumption.

PURIFYING AGENTS

(1) *Lime*

On heating limestone to a temperature of 1000°–1300° C., the following decomposition takes place:—

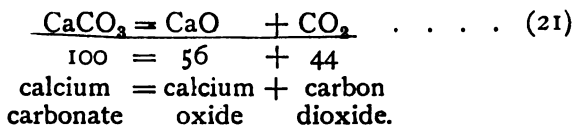

Limestone occurs in numerous forms, including lime-spar, marble, coral, etc. When the lime is required for purifying sugar juices, the limestone should contain at least 95% of the pure substance—calcium carbonate, and not more than 10% of any one of the following impurities:—magnesia, iron oxide, alumina, silica, sulphur trioxide, and matters insoluble in hydrochloric acid. The decomposition of the limestone by heat, commonly called “burning,” yields a solid product—“burnt” lime, also called quicklime, temper-lime, or lime. This should not contain more than 20% of any one of the above-mentioned impurities, and of carbon dioxide and moisture, and not more than 0.5% of sulphur trioxide.

Lime combines with water to form calcium hydroxide, or *slaked lime*, thus:—

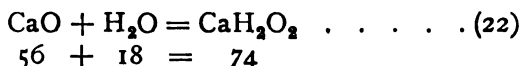

Much heat is evolved, and the lime swells and crumbles into a fine powder. The resulting hydroxide is very slightly soluble in water (1 part in 700 parts), forming a clear, alkaline solution, called lime-water, which is much too dilute for use in the sugar factory. Calcium hydroxide is much more soluble in sugar solutions, than in water, owing to the formation of soluble calcium saccharates (p. 113), which are strongly alkaline.

↓
 (1) In the manufacture of white sugar by the *carbonation process* (to be described later), the juice is first treated with a large quantity of lime; and subsequently with carbon dioxide gas to precipitate the excess of lime in the form of insoluble carbonate, which can be removed by filtration. In

this process, the limestone is "burnt" in a special form of kiln at the sugar factory, so that the two products (equation (21)) are obtained on the spot. The carbon dioxide gas is pumped from the top of the kiln through piping to the carbonating tanks, whilst the quicklime gravitates through the kiln and is discharged at bottom.

In the manufacture of raw sugar, yellow sugar, and white sugar (excluding the *carbonation process*), there is no necessity to burn the limestone on the spot, and the lime is generally imported, ready for use.

(1) *Dry Lime*.—In the *carbonation process* for cane- and beet-juices, the lime may be added in coarse lumps, and allowed to "slake" in contact with the juice. The resulting calcium hydroxide combines with the sucrose of the juice, forming calcium saccharate (p. 133), which renders the juice strongly alkaline. Further details will be found in Chapter XIX (pp. 229–231).

(2) *Lime-cream*.—When only a small quantity of lime is added per 1000 gallons of juice, as in the *defecation* and *sulphitation processes*, the above method is quite unsuitable, because the quantity of lime to be added must be carefully adjusted to produce the desired effect. In this case, it is added in the form of a fluid or cream, prepared as follows.

A large quantity of dry lime is moistened with water in an open vessel, and left for an hour or two to ensure complete slaking. The powdery hydroxide is then mixed with sufficient cold water to form a cream, of about 20° Beaumé density. This mixing may be done by manual labour, but a mechanical mixer is preferable; in which case, the slaking vessel is cylindrical, and the stirrers are attached to a central, rotating shaft. The cream is passed through two or more wire-gauze strainers, of different mesh, which separate particles of unburnt lime, unslaked lime, sand, etc.; leaving only the finely divided calcium hydroxide in the cream. The foregoing operations are preferably carried out in a shed, or outbuilding, and the strained lime-cream is pumped to a lime-storage-tank, adjacent to the tanks in which the juice is limed.

Here, it may be further diluted with water to a density of 15° Beaumé, and then contains 13.3% of calcium oxide

by weight, or 148 grams per litre (= 1.48 lbs. per gallon). This particular density is not essential, but a constant density should be adopted, so that equal volumes of the cream always contain equal weights of dry lime, and therefore neutralise equal volumes of the same juice, in separate tanks. The density test may be applied either directly to the cream, or to a mixture of equal volumes of cream and water, the latter method being more reliable. Thus, if the original cream has a density of 15° Beaumé, the diluted cream should indicate 8° Beaumé, or 14.0° Brix. The original cream is too viscid for accurate readings of the hydrometer.

As the calcium hydroxide rapidly deposits from the lime-cream on standing, the contents of the lime-storage-tank should be thoroughly agitated before drawing off the measured volumes to be added to the juice. Hand-stirring being unreliable, mechanical stirrers are frequently employed. A convenient arrangement is to connect the bottom of the storage-tank to the suction-pipe of a small pump, the delivery-pipe from this pump extending horizontally beside the juice tanks, and finally returning to the top of the storage-tank, completing the circuit. The lime-cream is thus kept in continuous circulation, and can be drawn off from several cocks on the exterior circulating-pipe, one cock being opposite each juice tank.

The volume of lime-cream added to the juice varies with the quality of the canes crushed, and the method of chemical treatment. Assuming that a normal charge is 2 gallons of lime-cream per 1000 gallons of juice, and that 500 gallons of juice are treated per tank, the normal charge per tank will be 1 gallon, but may have to be modified, from day to day, according to the quality of juice to be treated. A metal quart cup, with handle, serves as the measuring unit; four cupfuls making a normal charge. This may then be increased, or reduced, by one-sixteenth, by increasing or diminishing the charge by a quarter-cup.

The purifying effect of lime-cream is not great, because only a few of the various non-sugars in the juice are capable of forming insoluble compounds with lime; and some of

these are only precipitated by a large excess of lime, rendering the juice strongly alkaline. In this condition, the application of heat would cause decomposition of the dissolved reducing sugars, and rapid darkening of the juice (see p. 116). This is avoided by neutralising the excess of lime by the addition of an acid, to form an insoluble lime-salt, which can be separated by filtration, or by subsidence. The neutralising agents employed are—phosphoric acid, sulphur dioxide, and carbon dioxide.

(2) *Phosphoric Acid*

This was formerly employed for neutralising slightly alkaline juice, which has been accidentally over-limed, and requires only a small addition of acid. The commercial acid is a syrupy liquid, containing from 30 to 40% of the pure, or anhydrous acid. Patented compounds, such as Ehrmannite, Clarine, Clariphos, and Newlandite, are pastes or powders, containing phosphoric acid in the form of superphosphates. These are also used for neutralising an excess of lime, by the formation of insoluble tricalcium phosphate; but are more generally employed to assist subsidence of the non-sugars precipitated by lime. For the latter purpose, additional lime-cream is added to the juice, followed by sufficient superphosphate to form tricalcium phosphate. This denser precipitate, blending with the lighter precipitate of non-sugars, facilitates subsidence of the latter.

Phosphoric acid (or its compounds) is used in the manufacture of Demerara yellow crystals, as will be explained in the following chapter. But, for neutralising alkaline juice, the less costly agent—sulphur dioxide—has now been substituted for phosphoric acid.

(3) *Sulphur Dioxide*

This is employed for two purposes:—(a) to neutralise an excess of lime, and, (b) to bleach the juice, by acting on the colouring matters. In both cases, the treatment is termed "*sulphitation*."

Liquid Sulphur Dioxide.—This has been employed for some time in beet-sugar factories, with much success. It con-

tains 99·8% of SO_2 , and is sold in tanks, containing up to 10,000 kilos., fitted with valves for drawing off the gas, as required.

Sulphur Dioxide Gas.—In the cane-sugar factory, the gas is produced by burning roll-sulphur in a current of air, as shown in equation (23). The air entering the sulphur-furnace should be dried by passing through a chamber filled with quicklime. As a considerable excess of air is necessary to maintain combustion, the resulting gas contains from 14 to 16% of sulphur dioxide, about 5% of oxygen, and over 80% of nitrogen. The gas is generated continuously, and immediately applied to the juice; so that the weight of sulphur burnt per hour is proportional to the quantity of juice treated per hour.

Neutralisation of the Juice.—In this case, the juice has been previously rendered alkaline, and the object of sulphitation is to neutralise this alkalinity. From the following equations, it is evident that 1 part of CaO requires $\frac{4}{7}$ part of sulphur to produce the necessary quantity of gas.

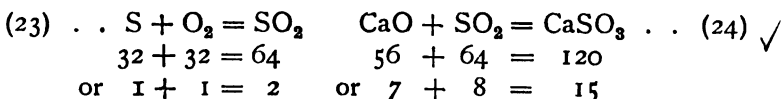

Assuming that 1000 gallons of juice contain 3 pounds of free CaO (equal to about 2 gallons of lime-cream), the weight of sulphur required is $\frac{3 \times 4}{7} = 1\cdot7$ pounds; and the weight of sulphur to be burnt per hour is determined by the gallons of juice to be treated per hour. As a small part of the sulphur volatilises without burning, and some SO_3 is formed, and as the SO_2 is not completely absorbed by the juice, the foregoing calculation only serves as a rough approximation; and the neutralisation of the juice must be controlled by chemical tests to be described later.

The correct proportion of SO_2 converts the excess of lime into the insoluble compound, calcium sulphite, which can be separated by filtration, or subsidence. If more gas be added, part of the calcium sulphite is converted into the soluble calcium bisulphite; the juice being rendered acid:—

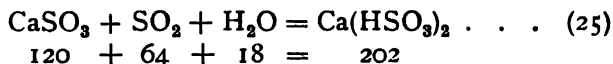

On boiling this juice in the multiple-effect evaporator, the bisulphite decomposes into its constituents,—sulphur dioxide gas, and insoluble calcium sulphite. The former rapidly corrodes the metal tubes of the evaporator, and the latter is deposited as “scale” on the surface of the tubes, thus interfering with the transmission of heat.

Apparatus used.—The sulphur dioxide gas is added to the juice by the methods described below.

(a) *Continuous Sulphitation.*—The juice flows continuously through the apparatus in which the gas is absorbed. The simplest arrangement is known as the *Sulphur Box*; consisting of a wooden chamber, or “tower,” from 12 to 18 feet in height, having numerous horizontal, or sloping perforated shelves, one above another. The juice is pumped to the top of the Box, and descends as a shower from shelf to shelf, escaping by an outlet at bottom. The gases from the sulphur-furnace enter at the bottom of the Box, and pass upwards through the descending shower of juice, being thus rapidly absorbed; any unabsorbed gas escaping through a chimney at the top of the Box. This apparatus therefore acts on the counter-current principle, and is satisfactory when a fairly constant volume of juice is treated per hour. The gas is forced through the Box by means of a steam-jet, acting as an aspirator, in the chimney, or, by means of a steam-injector at the gas-inlet at the bottom of the Box.

A more efficient apparatus is the *Quarez System* of continuous sulphitation. The juice is pumped through an injector, thereby drawing the gas from the sulphur-furnace into a vertical down-pipe, wherein the juice and gas come into intimate contact, and absorption takes place. The Quarez Apparatus comprises the following parts:—

- (1) Sulphur-furnace, with pipe-connection to juice-injector.
- (2) Juice tank, with vertical partition extending nearly to the bottom, and dividing it into two compartments:—the larger one, A, for sulphured juice, and a smaller one, B, for untreated juice; these two compartments being in communication at the bottom of the tank.

(3) A juice-pump, with suction-pipe drawing juice from compartment B of tank, and discharge-pipe forcing this juice through the nozzle of the injector.

(4) The injector, which stands about 6 feet above the juice tank, and is connected to the juice-pump, and also to the sulphur-furnace.

(5) A vertical down-pipe, which leads from the injector to the bottom of compartment A of juice tank, and is perforated at its lower extremity. This down-pipe acts as the absorption-chamber, the treated juice collecting in compartment A of the tank, and escaping through an overflow outlet near the top.

When the apparatus is in action, the untreated juice flows continuously into compartment B of the tank, is pumped through the injector, and descends through the down-pipe into compartment A of tank, whence it flows away. At the same time, sulphur dioxide gas is drawn into the down-pipe by the injected juice, any unabsorbed gas escaping through the perforations in the down-pipe and bubbling through the juice in compartment A of the tank. The operation is controlled by adjusting the speed of the pump, since the velocity of the juice through the injector determines the quantity of gas entering the down-pipe.

(b) *Intermittent Sulphitation.*—In this method, the gas is forced through perforated pipes submerged in juice in separate tanks, so that each tankful of juice is treated separately. An air-compressor supplies air to the sulphur-furnace, and forces the gas from the furnace into a gas-main with branch-pipes, each of which terminates in a perforated coil at the bottom of a tank. A cock on each branch-pipe regulates the quantity of gas entering each tank, and is closed as soon as the desired degree of acidity, or of alkalinity, is produced.

(4) *Carbon dioxide*

As previously stated, this gas is produced during the production of quicklime from limestone, the top of the lime-kiln being closed, and connected to a pump. The various types of kilns are illustrated and described in Ware's *Beet*

Sugar Manufacture and Refining, Vol. I, Part iii, chapter 1. Also, in Geerligs' *Practical White Sugar Manufacture*, pp. 129-139.

The necessary heat is produced by the combustion of coke in contact with the limestone, the proportions being 11 parts by weight of coke to 100 parts of limestone (or 1 volume of coke to 3 volumes of limestone). The coke is sometimes mixed with the crushed limestone, but, more generally, the two materials are added alternately at the top of the kiln, so as to form alternate layers. The "burnt" lime is removed from the bottom of the kiln, and fresh limestone and coke are added at the top, at intervals of three or four hours. The materials descend from the top to the bottom of the kiln in from 36 to 48 hours, and undergo the following changes, at different levels, in the kiln:—

(a) The upper layers are heated by the gases ascending from (b); this upper portion of the kiln being therefore termed the *heating zone*, although the maximum temperature is only reached in (b).

(b) The *decomposition zone*.—This occurs about midway up the kiln, and has a temperature of from 1200°-1300° C. The hot gases evolved from the decomposing limestone and burning coke pass upwards through the *heating zone* (a), heating the overlying layers of limestone and coke, and being thereby partially cooled before entering the pump from the top of the kiln.

(c) After descending through (b), the "burnt lime" is gradually cooled by the ascending current of air entering at the bottom of the kiln, this air-current being caused by the suction of the gas-pump at top of the kiln. Hence, this portion of the kiln (lying below (b)) is termed the *cooling zone* with reference to the "burnt lime," but is a *heating zone* with reference to the entering air. The heated air finally reaches the *decomposition zone*, and supplies oxygen to the burning coke.

Although the solid materials move slowly downwards through the kiln, the three zones (a), (b), and (c) remain stationary during continuous operation, by careful regulation of the gas-pump (which controls the supply of air for

combustion of the coke) and also by regulating the removal of "burnt lime" from the bottom of the kiln (which controls the rate at which the solid materials descend through the kiln).

The gases removed by the pump have the following approximate composition :—

Carbon dioxide	28.5%
Nitrogen	69.5%
Oxygen	1.5%
Carbon monoxide	0.5%
	100.0%

The proper working of the kiln is controlled by frequent analyses of the gases.

The size of the kiln is determined by the following considerations, as stated by Geerligs. The *cooling zone* should have a capacity equal to the volume of limestone burnt in 24 hours, so that the burnt lime descends through this zone in 24 hours. The *heating zone* and *decomposition zone* are each of half the above capacity, and the three zones have a combined capacity equal to twice the volume of limestone burnt in 24 hours. One cubic foot of crushed limestone weighs about 93 pounds, and yields $\frac{55 \times 93}{100} = 51$ pounds of burnt lime. This limestone is mixed with $\frac{1}{3}$ cubic foot of coke, making $1\frac{1}{3}$ cubic feet of material which gravitates through the kiln in 2 days (48 hours). Hence, the working capacity of the kiln must be in the proportion of $2\frac{2}{3}$ cubic feet per 51 pounds of burnt lime in 24 hours. As the working capacity is only about $\frac{3}{4}$ of the total height of the kiln (leaving a gas-space above), the total capacity is in the proportion of $2\frac{2}{3} \div \frac{3}{4} = 3\frac{1}{2}$ cubic feet, per 51 pounds of burnt lime; or 1 cubic foot, per 14.6 pounds of burnt lime. If a softer variety of limestone be used, the period of burning may be reduced from 2 days to 36 hours, thereby increasing the above output to $\frac{14.6 \times 2}{1\frac{1}{2}} = 19.4$ pounds of lime per cubic foot of total capacity.

Assuming that 40 tons of limestone are required per 1000 tons of cane in 24 hours (double carbonation process), the

yield of quicklime will be $\frac{40 \times 44}{100} = 17.6$ tons = 39424 pounds, and the total capacity of the kiln will be $\frac{39424}{14.6} = 2700$ cubic feet (if the limestone requires 2 days for burning). The carbon dioxide gas is derived, partly from the limestone, and partly from the burning coke. Allowing 2% impurities in the limestone, and 85% of carbon in the coke, we obtain:—

V
 100 parts of limestone yield about 43 parts CO_2 + 55 parts CaO + 2 parts of impurities
 11 parts of coke yield $11 \times \frac{85}{100} \times \frac{44}{12} = 34$ parts CO_2
 Total = 77 " "

Neutralisation of the Juice.—The two products—lime and carbon dioxide gas—which are separated from limestone in the kiln, are subsequently reunited in the juice, forming a granular precipitate of calcium carbonate, thus:—

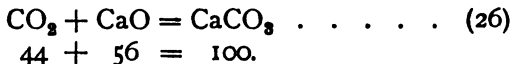

Consequently, the limestone supplies the exact proportions of alkali and acid to neutralise each other; the lime being added first to the juice, and subsequently precipitated by passing carbon dioxide gas through the alkaline juice. But, in this second operation (termed *carbonation*), much of the gas escapes unabsorbed, and, in extreme cases, only 60% is available for neutralising the previously added lime. This loss is made good by the additional carbon dioxide produced by combustion of the coke, as shown above. Thus, if only 60% of the gas be available, the total of 77 parts gives $\frac{77 \times 60}{100} = 46$ parts available to neutralise 55 parts of lime; or 3 parts of gas in excess of the theoretical quantity (43 parts). Under more favourable working conditions, the loss of gas during carbonation is much less, and the lime-kiln usually produces a considerable excess of gas (derived from coke) relative to the quantity of quicklime (derived solely from the limestone). The loss of gas has recently been eliminated in De Haan's method of carbonation (see pp. 197-198).

If more gas be added to the juice than is required to neutralise and precipitate the lime, the calcium carbonate (already formed) is gradually converted into the soluble bicarbonate, thus :—

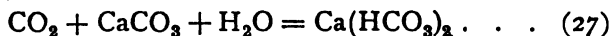

When this juice is boiled in the evaporator, the bicarbonate decomposes, carbon dioxide gas being set free, and insoluble calcium carbonate being deposited as "scale" on the heating-surface of the evaporator.

The similarity between carbonation and sulphitation will be evident on comparing equations (24) and (26), also equations (25) and (27).

Apparatus used.—The gas is pumped from the lime-kiln through a "washer," in which it is sprayed with water to remove suspended dust, and also to cool the gas. It then passes through a wide-bore pipe, having branch-pipes (with valves) to each carbonating tank. These are tall vessels, of from 700 to 2000 gallons capacity each, closed at top, and fitted with a chimney. The gas enters through a perforated pipe, or coil, at bottom of each tank, bubbles through a considerable depth of juice, and any unabsorbed gas escapes through the chimney at top. Each tank is usually fitted with a steam coil for heating the juice, also a door in the cover, from which samples of juice can be withdrawn for testing. Further details will be found in Chapter XIX (pp. 233–235).

BLEACHING AGENTS

In the manufacture of white and yellow sugars for direct consumption, the juice must be not only transparent, but also light in colour. As certain colouring matters are only partially precipitated by lime, additional chemical treatment is usually necessary, and the various decolourising processes may be classified as follows.

(1) Absorption of the colouring matters by bone-char, or other forms of carbon.

(2) Oxidation of the colouring matters, by such agents as ozone, peroxide of hydrogen, permanganates, chlorine, etc.

(3) Reduction of the colouring matters, or abstraction of oxygen, by such agents as sulphur dioxide and its com-

pounds, nascent hydrogen evolved from metallic powders and alloys, electrolytic action, etc.

Method (1)

Bone-char was first used in the beet-sugar industry in 1812, and also in the manufacture of white sugar from the cane; but its use is now restricted to the refining operations (described in Chapter XXXI) for the following reasons. Bone-char decreases in bleaching-power after absorbing organic non-sugars and colouring matters from the liquid; and, in order to restore its activity, it is ignited, or "revivified," in special furnaces, thus removing the previously absorbed organic matters. Owing to the large percentage of organic non-sugars in cane and beet juices, the bone-char requires frequent ignition, involving extra fuel and labour. On the other hand, the raw sugar entering the refinery has been separated from the greater part of the non-sugars in the original juice by centrifugal treatment. When these crystals are dissolved in water, they yield a fairly pure, although dark-coloured syrup, to which the bone-char treatment can be applied with much better effect than to the raw juice, or syrup, from which the crystals were extracted.

During recent years, special *decolourising carbons* have been put on the market, under the names of *Norit*, *Eponit*, etc.; and which possess 30 times the decolourising power of bone-char. Their suitability for sugar-refining has been proved by large-scale experiments, but their high cost has so far prevented their general application in cane- and beet-sugar factories.

Methods (2) and (3)

Whereas bone-char acts mechanically by absorbing the colouring matters from the juice, the following bleaching agents transform the colouring matters into colourless compounds, without separating them from the juice. This chemical change is effected, either by adding oxygen to the molecule of colouring matter (oxidation); or, by abstracting oxygen (reduction). In the case of oxidation, the bleaching effect is permanent, because the oxidised molecule usually breaks up into simpler compounds. In the case of reduction,

the chemical change is more superficial, the original colour being restored by oxidation, for example, by exposure to the atmosphere.

Although oxidation methods of bleaching sugar juices would be preferable, these have not yet been successfully developed, and it is necessary to employ reducing agents, such as sulphur dioxide and its compounds, the hydro-sulphites.

Sulphur Dioxide.—This bleaching agent was first suggested as a substitute for bone-char in 1810, and was employed in beet-sugar factories about 1849, and in cane-sugar factories about 1860. The methods of preparing this gas, and adding it to the juice, have been described above. Sulphur dioxide acts as a bleaching agent only in acid solutions (*i. e.* in the presence of other acids, or when sulphur dioxide is added in excess); and, on neutralising the bleached juice with an alkali, the original colour is restored. Any mineral acid reduces the colour of cane- and beet-juices; but the reduction in colour due to sulphur dioxide, is about double that produced by either sulphuric, or hydrochloric acids, indicating that the effect of sulphur dioxide is not solely due to acidification.

The danger of inverting sucrose when the juice is rendered acid by sulphur dioxide is very small, owing to the formation of neutral sulphites, with liberation of free organic acids, as follows:—

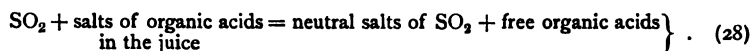

If the sulphur dioxide be added carefully, the acidity of the juice is due to the liberated organic acids, which possess very feeble inverting powers, even at high temperatures. Acidity due to free sulphurous acid can only occur after complete decomposition of these organic salts.

The bleaching treatment may precede, or immediately follow the treatment with lime, provided that the relative proportions of lime and gas are adjusted to yield a faintly acid juice. Sometimes a second sulphitation is applied after the juice has been concentrated to syrup, so as to obtain the maximum bleaching effect before the syrup is converted into

crystals by further concentration in the vacuum pan. As the thick syrup does not readily absorb the gas, a mechanical "mixer" is required to agitate the syrup whilst the gas is forced through it from a perforated coil at bottom of the vessel. A slight degree of acidity, due to free SO_2 , produces much less inversion of sucrose when treating syrup than when treating juice, so that sulphitation of syrup may be carried somewhat further than would be considered safe for juice.

Hydrosulphites.—Sodium and calcium hydrosulphites, known as *Blankit* and *Rédo*, respectively, are largely used in the manufacture of white cane- and beet-sugars. They possess a much higher bleaching-power than sulphurous acid; and, unlike the latter, they bleach equally well in the presence of acids and alkalis. Sodium hydrosulphite is prepared by combining zinc, sodium bisulphite, and sulphuric acid, with the formation of zinc hydrosulphite, the latter being then treated with sodium carbonate, as in the two following equations:—

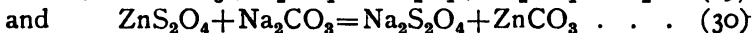
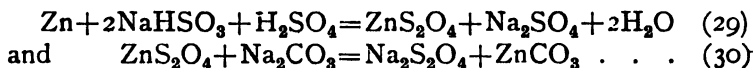

The zinc carbonate is separated by filtration, and the sodium hydrosulphite is crystallised from the filtrate. The commercial salt is a white hygroscopic powder, which must be stored in air-tight vessels. The bleaching action is due to the abstraction of oxygen from the colouring matter with the formation of sodium bisulphite, thus:—

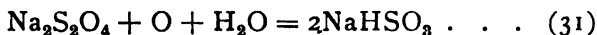

The sodium bisulphite can abstract a further quantity of oxygen, thus:—



As the oxygen thus abstracted from the colouring matter is gradually restored on exposure to the atmosphere, the bleaching action is only temporary, resembling that of sulphur dioxide, and in order to avoid such oxidation, the hydrosulphites are added to syrup, instead of to the juice. The patentees claim that from one to five pounds of Blankit will decolourise five tons of sugar in the form of syrup, but

practical experience proves that fully one pound per ton of sugar is necessary. The powder is dissolved in a little syrup, and drawn into the vacuum pan (through the "butter-cock"), half the required quantity being added just before crystals are formed and the remaining half, at intervals, during the subsequent growth of the crystals. Hydrosulphites are generally used in conjunction with sulphitation of the juice.

APPARATUS FOR HEATING THE JUICE

As the purifying action of lime is only complete at high temperatures, heat may be regarded as an essential factor in the chemical treatment, and certain effects are due to heat alone, namely:—

- (1) Destruction of living organisms which cause fermentation, acidity, etc. Heat is therefore an antiseptic agent.
- (2) Removal of emulsified air from the juice.
- (3) Heat lowers the density of the juice, relative to that of the suspended solid matters forming the lime-precipitate, thus favouring subsidence of the latter.

Apparatus for heating the juice (and syrup) may be classified as follows:—

(a) *Raising the Temperature of the Juice during Chemical Treatment*

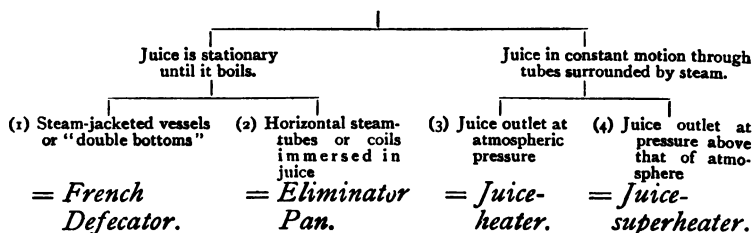

(b) *Maintaining the Juice or Syrup at Boiling Point during Evaporation of Water*

(These will be considered in Chapter XXI.)

(a) *Method (1): Steam-jacketed Vessels.*—The *French Defecator* was originally designed for treating beet juice, extracted by rasping and hydraulic pressure, but was abandoned when the diffusion method of extraction was adopted, because the

purier diffusion juice could not be defecated by lime alone, but required the more complicated treatment of liming followed by carbonation.

The *French Defecator* has been extensively used in the cane-sugar factory, and is still employed in the manufacture of white sugar, especially in Mauritius. High-pressure steam is the heating agent, and a very large amount of steam is consumed if the juice enters the defecators cold, as was the practice formerly. To-day, the juice is more economically heated to about 180° F., in tubular juice-heaters (method (3)) by means of exhaust steam, only the final stage of heating being effected in the *French Defecator* with live steam. The same principle is adopted in the modern *Hatton Defecator* (p. 201).

Method (2): Steam Tubes, or Coils, immersed in Juice.—This type of heater was formerly used (in place of the more costly *French Defecator*) for heating the cold juice to the boiling point during chemical treatment, but has long been abandoned in favour of the more economical method (3). The system is adopted in the *Eliminator Pan* for the following purpose. The juice is limed, heated to boiling point in the juice-heater (method (3)), and subsided in settling tanks. The hot, clear juice is decanted from the sediment, and briskly boiled in the *Eliminator Pan* (where it may be treated with phosphoric acid). Any suspended impurities (which have not subsided in the settling tanks) rise into the foam of the boiling juice, this foam being “brushed” over the top of the *Eliminator Pan* into a gutter surrounding it. This operation is essential in the manufacture of Demerara yellow sugar.

Method (3): Juice flowing through Tubes heated externally by Steam.—This is the modern system of heating the juice, either before or after chemical treatment. The juice flows through numerous parallel brass tubes, the opposite extremities of which are “expanded” into tube-plates at opposite ends of the heater. The space enclosed between the two tube-plates and the cylindrical body of the heater forms the steam-chamber, having a steam-inlet valve, and a condensed-steam outlet leading to a steam-trap. Each tube-plate is adjacent to an exterior cover, or door (which can be opened for the

purpose of cleaning the interior of the tubes), and the shallow space between each tube-plate and the adjacent door forms a juice-chamber, communicating with the interior of all the tubes. The cold-juice-inlet is between the tube-plate and door at one end of the heater, and the outlet for the heated juice is in the opposite juice-chamber.

In the simplest type, or "single flow," the juice passes through all the tubes simultaneously, thus reaching the opposite juice-chamber and the outlet. A "triple flow" is effected as follows. Each of the two juice-chambers is divided by baffle-plates into two unequal compartments, namely, A and C, at one end of the tubes, and B and D at the opposite end. The cold juice enters the small compartment A, and flows through a certain number of tubes into compartment B. It now returns through a second group of tubes (included in compartment B) and enters compartment C. Here, it again returns through a third group of tubes, thus reaching a smaller compartment D, and the outlet.

Usually, two *Juice-heaters* are connected "in series," and both are heated by exhaust-steam from the factory engines. The cold juice is heated to a fairly high temperature in the first heater, then passes into the second, where the temperature is further raised to boiling point. Baffle-plates may also be inserted in the steam-chamber in such positions that the steam and juice travel in opposite directions, thus securing maximum efficiency.

As the juice escapes freely from the outlet of the heater, its temperature cannot exceed the normal boiling point (at atmospheric pressure). It may be slightly superheated by extending the outlet pipe vertically upwards so as to produce hydrostatic pressure at the outlet of the heater. In this case, the heaters would be situated on the ground-floor, and the heated juice delivered to the subsiding-tanks on the top-floor.

Method (4): Superheating.—It is generally claimed that chemical treatment is rendered more effective by superheating to a temperature of about 240° F., the precipitate being more flocculent, and therefore subsiding more rapidly. The cold juice is heated nearly to boiling point by means of exhaust-steam in the first of two heaters, and is then superheated by

means of high-pressure steam in the second heater, which is fitted with a spring-valve on the juice-outlet. The juice is thus subjected to any desired pressure within the heater, and is forced through the two heaters by means of a pump. After passing through the spring-valve, the superheated juice enters a third vessel, called a *steam-separator*, wherein the juice is brought under atmospheric pressure. Here, a large quantity of steam escapes from the juice, and the temperature falls to the normal boiling point. The liberated juice-steam collects in the "separator," and may be employed as a heating agent in other departments of the factory, whilst the juice flows from the separator to the settling tanks.

Superheaters are usually so designed that the juice flows through numerous groups of small tubes at a high velocity. For this purpose, the two juice-chambers (at opposite ends) are subdivided into numerous compartments by means of baffles, as described under method (3) above.

The principles involved in the transmission of heat from the steam to the juice will be considered in Chapter XX, which deals with the evaporation of water from the juice.

CHAPTER XVII

CHEMICAL TREATMENT OF CANE JUICE

THE nature of this treatment is determined by two considerations, namely:—(a) the quality of the sugar to be manufactured; and (b) the quality of the juice to be treated.

The qualities of sugar made include:—(1) raw sugar, which receives further purification in the refinery; (2) moist yellow sugar, for direct consumption; and (3) white sugar, for direct consumption.

In the manufacture of raw sugar, the juice may be purified by two methods:—(a) *defecation*, and (b) *neutral-sulphitation*; according to the nature of the non-sugars it contains. Similarly, in the manufacture of white sugar, the juice may be purified by:—(a) *acid-sulphitation*, and (b) *carbonation*. The manufacture of refined white sugar from raw sugar will be considered in Chapters XXXI and XXXII.

The present chapter deals with the chemical precipitation of non-sugars from the juice. The separation of the resulting precipitate from the treated juice is a mechanical operation which will be fully considered in the following chapter.

(1) MANUFACTURE OF RAW SUGAR

The production of raw cane sugar greatly exceeds that of white and yellow sugars, and the extreme simplicity of the *defecation process* will serve as an introduction to the more complicated processes, *sulphitation* and *carbonation*, employed in the manufacture of white sugar.

(a) *The Defecation Process for Raw Sugar*

Lime-cream is added to the juice in just sufficient quantity to render the juice neutral, or very faintly alkaline. After

being heated to boiling point, the limed juice is discharged into settling-tanks, where the precipitated non-sugars are allowed to subside. The effect of this treatment is as follows:—

(1) The free organic acids of the juice are neutralised, forming neutral lime-salts, which, being soluble, are not precipitated.

(2) The following non-sugars are precipitated:—albumin (both the soluble and insoluble forms); acid calcium phosphate is precipitated in the form of insoluble tri-calcium-phosphate; of the total nitrogen compounds, about 80% are precipitated; of the soluble colouring matter—anthocyan, only a small percentage is precipitated; similarly, only a small percentage of the soluble pectin, and none of the cane gum (xylan).

(3) The precipitation of the above non-sugars causes an increase in the Quotient of Purity of the juice (p. 147) of about one unit; for example, from 85 to 86. As the raw juice, of 85 Purity, contains about 9 parts of total non-sugars per 100 parts of total dry solids, the purifying effect of lime + heat, removes only about one part of non-sugars out of nine, or 11.0%.

(4) After the precipitated non-sugars have subsided, the juice becomes transparent, because the flocculent lime-precipitate envelopes the fine solid particles previously suspended in the raw juice (rendering it opaque), but which are now carried down by the heavy precipitate resulting from chemical treatment.

(5) The golden-yellow colour of the neutral clarified juice is due to the colouring matter of the juice, and increases if sufficient lime be added to render the juice slightly alkaline. Decided alkalinity must be avoided, because any excess of lime decomposes the reducing sugars, with the formation of dark-coloured products (see p. 116).

The lime may be added to the juice either before, or after the latter has been heated, the final result being the same provided that the temperature be not less than 190° F., although a higher temperature is preferable.

Liming Cold.—The juice is pumped from the mill to a

series of liming tanks (also used as measuring tanks), where about 2 gallons of lime-cream are added per 1000 gallons of juice, and carefully mixed with the juice. A second pump forces the limed juice through two or more juice-heaters (pp. 175, 176), and the hot juice passes through a "juice-main" pipe, with branch-pipes to numerous settling tanks, or "*subsiders*." The latter are filled in turn, and left undisturbed for one hour, after which the clear juice is drawn off, leaving the sediment behind. The sediments from several subsiders pass to another vessel (*re-subsider*), are heated to boiling point by steam, re-subsided for an hour, and then yield about 50% clear juice, and 50% sediment. The latter is boiled, and pumped through filter presses (p. 213), yielding clear filtered juice, and a semi-dry "cake" of separated impurities.

To ensure rapid subsidence, the hot juice, leaving the juice-heaters, is sometimes boiled for a few moments in tanks fitted with steam coils, before passing to the settling tanks. Or, the juice may be superheated by one of the methods described on p. 177.

Liming cold is theoretically correct because the subsequent heating cannot cause inversion of sucrose, but has the serious disadvantage that the non-sugars are precipitated in the heater, and deposit on the tubes, forming a "scale" which retards the transmission of heat. This objection is eliminated in the following method:—

Liming Hot.—The juice is pumped from the mill through two or more juice-heaters, and thence through a "juice-main" pipe to the settling-tanks. Lime-cream is then added, and thoroughly mixed with the hot juice by the time each tank is filled. The precipitated impurities are then separated from the juice by subsidence, re-subsidence, and filtration, as explained above. The mixing of the juice and added lime-cream can be effected automatically by extending the juice-inlet-pipe to the bottom of each tank, causing the steam (generated in the juice-heater) to blow through the mass of juice in the tank until the latter is filled, and the juice-inlet cock closed.

As only a few minutes elapse between heating and liming, the loss of sucrose by inversion is negligible, owing to

the low inverting power of the organic acids present. But, when diseased or stale canes are being milled, the acidity of the juice (due to acetic acid) may be sufficient to cause serious loss of sucrose by inversion. Liming hot is applicable under normal working conditions, and is the only remedy when the juice is infected with the *Leuconostoc mesenteroides* (see p. 134).

Control Tests.—In either method of liming, the quantity of lime-cream added per 1000 gallons of juice obviously depends on the acidity of the juice extracted by the mills from day to day, and is ascertained by the following tests:—

1. *Litmus Test-papers.*—These should be of the best quality. The neutral (violet) paper is preferred, being more sensitive than the red and blue papers. After the chemical treatment described above, the juice should be neutral, or very faintly alkaline.

2. *Settling Test.*—A glass test-tube (about $\frac{3}{4}$ inch diam.), attached to the end of a wooden handle, is plunged into the limed and heated juice, withdrawn, and the contents observed in a good light. The precipitate should be flocculent, and subside well, leaving the juice transparent, and of a pale yellow colour (for raw sugar). As this test can only be applied *after* the juice has been heated, it is more applicable when the juice is limed hot, because the effect of varying the quantity of lime can then be seen immediately. When liming cold, the test must be applied to the hot juice as it flows into the settling tanks; but, as these may be far distant from the cold-liming tanks, the man in charge of the latter cannot apply the test himself, but must be informed if the result is not satisfactory.

3. *Sucrate of Lime Test.*—About 20 parts of white sugar are dissolved in 80 parts of clean water, and shaken for a few minutes with a small quantity of lime-cream. The mixture is filtered, and the clear filtrate stored in a “dropping bottle.” The sample of juice, in Test No. 2, is filtered and two or three drops of the above solution added to the filtered portion. A slight cloudiness is generally produced; yet, if the juice be faintly alkaline to litmus-paper before applying the test solution, it has been sufficiently limed. If no

turbidity is observed, the juice has probably been overlimed, and the proportion of lime-cream added to the following tanks of juice can be slightly reduced until a slight cloudiness is produced on applying the test.

When the quality of the juice fluctuates from hour to hour, the control of the liming becomes very difficult. Certain tanks of juice may be overlimed, and others underlimed, but such errors tend to compensate each other. When liming cold, the contents of two or more liming tanks are united in a single settling tank, usually of large capacity. When liming hot, a tank of underlimed juice can, at once, receive additional lime-cream, before subsidence begins; whilst a tank of overlimed juice eventually mixes with the entire bulk of subsided clear juice, entering the multiple-effect evaporator.

(b) Neutral-sulphitation Process for Raw Sugar

Certain non-sugars are only partially precipitated in the Defecation Process just described, but are more completely precipitated by a larger addition of lime-cream, such as renders the juice strongly alkaline to litmus-paper. In this alkaline condition, the juice would become very dark in colour when heated, and must therefore be first carefully neutralised by sulphur dioxide, as follows:—



The product, calcium sulphite, is almost insoluble, and forms a heavy precipitate which can be separated by subsidence.

The excess of lime is usually added first, and the following non-sugars—pectin, anthocyan, and gum are more completely precipitated than in the Defecation Process. After sulphitation, the juice should be neutral, or very faintly alkaline; in which case, the sulphur dioxide has no bleaching effect (this not being desired in the production of raw sugar). It is claimed that sulphitation reduces the viscosity of the syrup and molasses derived from the juice, thus facilitating crystallisation in the vacuum pan, and the subsequent separation of molasses from the crystals in the centrifugal machines. The increase in Quotient of Purity of the juice, after liming and

sulphitation, is about the same as in the Defecation Process ; namely, one unit, for example, from 85 to 86. It is true that more non-sugars are precipitated in the Sulphitation Process, but the quantity is too small to appreciably influence the Quotient of Purity.

Liming followed by Sulphitation

This is the usual practice in Java. The juice is pumped from the mill to the cold-liming tanks, where from 4 to 6 gallons of lime-cream are added per 1000 gallons of juice (about twice the quantity added in the Defecation Process). The cold alkaline juice is pumped to the sulphitation tanks, in which the gas is caused to bubble through the juice. The completion of the sulphitation is determined by the *control tests* described below, after which the neutralised juice is pumped through two juice-heaters, and enters the settling tanks, or *subsiders*.

Sulphitation followed by Liming

This mode of working is generally adopted in Louisiana and Brazil, and practical experience indicates that the final result is the same as when liming precedes sulphitation. In the latter case, the juice is first rendered strongly alkaline, and the non-sugars appear to be precipitated by the free alkali. But, when liming follows sulphitation, the juice is first rendered strongly acid, and does not become strongly alkaline at all ; yet the non-sugars appear to be precipitated as readily as in the other method. A satisfactory explanation has not yet been given, but Geerligs suggests that the precipitated calcium sulphite (common to both methods) attracts and "fixes" the colloidal non-sugars (see remarks under *Acid-sulphitation for White Sugar* on pp. 190, 191).

The juice is pumped from the mill to the *Sulphur Box* (p. 166), then enters the cold-liming tanks where lime-cream is added until the juice becomes neutral, when it is pumped through juice-heaters to the *subsiders*.

Whether liming before, or after sulphitation, the quantity of lime-cream added per 1000 gallons of juice (and, consequently, the quantity of sulphur dioxide also added) is

mainly determined by the rate of subsidence in the settling tanks (see *Settling Test* below) and the firmness of the filter-press cakes. On the other hand, the relative proportions of lime and sulphur dioxide to yield a neutral or faintly alkaline juice, must be ascertained by the following tests.

Control Tests.—When the excess of added lime is exactly neutralised by sulphitation, the neutral calcium sulphite is precipitated, although a small quantity remains in solution in the treated juice (due to its slight solubility). Van der Linden gives the following figures:—

	<i>In Water.</i>	<i>In Juice.</i>
Solubility of $\text{CaSO}_3 \cdot 2\text{H}_2\text{O}$ at 30° C.	0·064%	0·104%
at 60° C.	0·061%	0·071%
at 100° C.	0·011%	0·030%

The same neutral salt is obtained when sulphur dioxide gas is applied first, and the acid juice afterwards exactly neutralised by lime-cream. But, in the former method, the free lime decomposes the potassium salts present in the juice, and the free potash combines with sulphur dioxide, forming neutral potassium sulphite, which is completely soluble in water and in juice.

These soluble sulphites of calcium and potassium, although neutral from a chemical point of view, give a slight alkaline reaction on red-litmus-paper, and a slight acid reaction towards phenolphthalein indicator. The following tests are based on these considerations.

Liming and sulphitation are applied to the cold juice, and usually on the ground-floor of the factory. The effect of such treatment cannot be accurately judged until the juice has been heated to boiling point, and flows into the settling tanks or *subsiders*, these being generally on the upper-floor of the factory. Every hour, two samples of hot juice are brought down to the workman in charge of the liming and sulphitation:—

Sample 1 is muddy juice, flowing from the juice-heaters into the *subsiders*, and which has just previously been limed

and sulphited. This sample is used for the *Settling Test* described under "*Defecation Process*," on p. 182.

Sample 2 is clear juice, flowing from the *subsiders* to the multiple-effect evaporator, and which was limed and sulphited about one hour previously.

Both samples should show a faint blue colour on red-litmus-paper, and no pink colour on white-phenolphthalein-paper (the latter test-paper may be dispensed with, but is sometimes used). The factory chemist supervises these tests, and occasionally confirms them by further quantitative tests (*i. e.* titration of juice against $\frac{N}{10}$ alkali) in the laboratory (see under "*Laboratory Tests*" on pp. 189 and 192). For the workman's guidance, the chemist selects a sample of clear treated juice (from one of the numerous *subsiders*) which proves satisfactory by the laboratory test, and the workman is required to adjust the liming and sulphitation to yield subsided juice of equal depth of colour, and giving the same blue tint to red-litmus-paper. The colours of the standard and hourly samples are compared, side by side, in test-tubes of $\frac{3}{4}$ inch diam.

As the test-papers are rendered useless on exposure to air containing sulphur dioxide, the foregoing tests should be made at a sufficient distance from the sulphitation apparatus, and preferably close to a window in order to obtain a good light. A shelf may be fixed in front of this window, at a height of 4 or 5 feet from the floor, and equipped with a dozen test-tubes in a stand, corked bottles containing the test-papers, and bottle of standard juice, mentioned above.

(2) MANUFACTURE OF "DEMERARA YELLOW SUGAR"

The slightly acid raw juice is pumped from the mill to the *Sulphur Box* (p. 166), where it absorbs sulphur dioxide, becomes bleached, and leaves the apparatus with a moderate degree of acidity. From $1\frac{1}{2}$ to 2 pounds of sulphur are burnt per 1000 gallons of juice treated. A second pump passes it through one or more juice-heaters into the *subsiders* or settling tanks, its temperature now being raised to about 100° C. Sufficient lime-cream is added to the hot juice

to nearly neutralise the previous acidity, leaving the juice faintly acid to blue-litmus-paper, the added lime-cream being thoroughly mixed with the juice before applying the test. The precipitate is allowed to subside during 1 to 1½ hours, and the clear juice should have a pale straw colour, due to the bleaching action of the sulphur dioxide in the presence of acids (see p. 173).

This clear juice is run off into *Eliminator Pans* (p. 176), treated with phosphoric acid, and briskly boiled. This treatment causes the juice to assume a golden-yellow colour, and decomposes soluble lime salts with formation of insoluble tricalcic phosphate. This precipitate (also traces of the original precipitate which failed to subside) rise into the foam on the boiling juice, and are separated by "brushing" (p. 176). This completes the chemical treatment of the juice.

Further chemical treatment is applied to the syrup in the vacuum pan, for the following purpose. The juice darkens in colour during concentration to syrup, due to oxidation of organic lime-salts. Formerly these salts were decomposed by adding a little sulphuric acid to the syrup during crystallisation in the vacuum pan, thus restoring the bright yellow colour before crystals are formed. Sulphuric acid has long been abandoned in favour of stannous chloride (chloride of tin), a powerful reducing agent, a solution of which is drawn into the vacuum pan shortly before the massecuite is discharged. The dark-coloured mother-liquor (syrup) then assumes an intense yellow colour, no artificial colouring matter being added at any stage of the manufacture. When the massecuite is "cured" in the centrifugals, the crystals remain coated with a film of this yellow mother-liquor and are not purged with water or steam.

This genuine Demerara Sugar has been imitated by adding aniline dyes to white sugar crystals, made from cane or beet; but, although the dyed sugar may be equally attractive in colour, it lacks the pleasant flavour of the genuine article. The term Demerara Sugar has been legally defined as—"a moist yellow sugar manufactured from the sugar-cane," without reference to the method of manufacture, or to the particular country in which it is produced. By this legal

definition, dyed cane sugar may be sold as "Demerara Sugar" without liability to prosecution under the "Sale of Foods and Drugs" Act, and this decision is, naturally, resented by the producers of the genuine article.

As stated above, the raw juice (slightly acid) is rendered still more acid by sulphitation, and heated to boiling point, before addition of lime-cream. Under these conditions, some loss of sucrose by inversion is unavoidable, but is compensated by the high market-value of this grade of sugar (relative to raw sugar). Inversion could be avoided by liming first, and sulphiting to slight acidity before heating; but this order does not give the same satisfactory yellow sugar. By liming first, the juice becomes distinctly alkaline, and this alkalinity has some influence on the colouring matters which cannot be rectified by the subsequent sulphitation and acidity.

Control Tests.—Demerara sugar was successfully produced long before the chemist made his appearance in the factory, and the operations are still generally controlled by the following simple tests:—

Sulphitation of the raw juice is regulated by the combustion of from $1\frac{1}{2}$ to 2 pounds of sulphur per 1000 gallons of juice treated.

The addition of lime-cream to the sulphited and heated juice is called *tempering the juice*, the special aim being to produce a precipitate which settles rapidly, leaving the juice as transparent as possible, and of a light colour. Hence, the importance of the *Settling Test*, previously described on p. 182.

Test-papers.—To obtain the desired transparency, it may be sometimes necessary to lime the juice until faintly alkaline to litmus-paper (= *tempering high*), the colour of the juice becoming much deeper than is desirable, but this can be corrected by the addition of phosphoric acid in the *Eliminator Pans* (p. 176). Generally the desired transparency can be obtained when the juice is neutral to litmus-paper, and of a pale greenish-yellow colour; or the juice may remain faintly acid, and still lighter in colour (= *tempering low*). Consequently, the colour of the treated juice, and its reaction to litmus-paper, vary with different varieties of cane treated,

and is ascertained by experience in different factories. The colour of the clear, subsided juice is finally adjusted in the *Eliminator Pans*, just sufficient phosphoric acid being added to yield a golden-yellow juice, which is distinctly acid to litmus-paper.

Laboratory Tests.—In recent years, chemists have aimed at a more accurate control by measuring the acidity of the juice at each stage of the chemical treatment. This acidity is defined as the number of cubic centimetres of decinormal sodium hydroxide solution required to neutralise 100 c.c. of juice, using phenolphthalein as indicator. (It should be remarked that neutral calcium and potassium sulphites appear faintly acid to this indicator, as explained on p. 185.)

After the initial sulphitation, the total acidity (*i. e.* natural + that due to SO_2) should not exceed 20, in order to minimise the loss by inversion when heating in the juice-heaters. After tempering, the acidity should be reduced to about 5, according to the quality of the juice treated, and the quantity of lime required to produce transparency, after subsidence of the precipitate. The addition of phosphoric acid in the *Eliminator Pans* increases the acidity to from 12 to 20. In Louisiana, the acidity is expressed on 10 c.c. of juice, and is therefore only one-tenth of the above values.

(3) MANUFACTURE OF WHITE SUGAR

This involves a more thorough purification of the juice and syrup than is necessary in the manufacture of raw sugar, and the treatment differs somewhat from that required in the production of yellow sugar. The two standard processes for white sugar are:—*Acid-sulphitation* and *Carbonation*, each of which has various modifications. In the former process the colouring matter of the juice is bleached (as in the treatment for yellow sugar), and the bleaching treatment is generally repeated after concentrating the juice to syrup. In the second process, or *carbonation*, no bleaching agents are used, but a light-coloured juice and syrup are obtained by avoiding those conditions which render the juice dark in colour; namely, the decomposition of reducing sugars by free alkali.

Transparency of the juice and syrup is even more essential than absence of colour; because the sucrose, crystallising from the syrup, deposits upon the particles of suspended solid matter, and completely envelopes them during the subsequent growth of the crystals. The dark particles are thus embedded in the fully-grown crystals, imparting their colour to them. On the other hand, a coloured syrup is outside the crystal, and can be removed from its surface by washing in the centrifugal, as described on p. 303.

The complete separation of suspended impurities by subsidence, is rarely possible, for the subsided juice is never as transparent as filtered juice. Moreover, during concentration of the juice to syrup, certain mineral matters become insoluble, rendering the syrup cloudy and even opaque. Filtration of the whole of the juice, and a second filtration of the syrup is practicable in the *Carbonation Process*, but not in the *Acid-sulphitation Process*, for reasons to be considered in the following chapter.

(a) *Acid-sulphitation Process for White Sugar.*

In the manufacture of white sugar, sulphur dioxide is mainly used as a bleaching agent, and, for this purpose, the juice must remain sufficiently acid instead of being neutralised (as in the *Neutral-sulphitation Process* for raw sugar). The process is only successful when treating light-coloured canes, because dark canes contain much anthocyan (p. 131), and this substance is only partially bleached by sulphur dioxide.

In Java the juice is first limed to strong alkalinity, then rendered faintly acid by sulphitation. In Louisiana and certain other countries, the above order is reversed, but either method yields the same result provided that the juice has the same final acidity (see remarks under *Neutral-sulphitation for Raw Sugar* on p. 184). As regards bleaching effect (which is here essential), the order of chemical treatment appears to be immaterial in the case of cane juice. Aulard's investigations on beet juice indicate a greater bleaching effect when sulphitation precedes liming; and he concludes that when lime is added first, the liberated potash-

alkalinity "fixes," or combines with the colouring matters, causing the subsequent bleaching action of sulphur dioxide to be less effective than when applied before liming.

Sulphitation before liming is adopted for cane juice in Louisiana with a view to keeping the juice acid thus avoiding any possible decomposition of reducing sugars (with darkening of the juice) by the action of free lime. But as such decomposition is not likely to occur before the juice is strongly heated, this practice does not appear to be very well founded, and possesses certain disadvantages.

The chief difference between sulphitation before and after liming may now be mentioned. In the former method the gas merely dissolves in the juice up to the limit of its solubility, and the resulting acidity limits the quantity of lime-cream required to neutralise it. But when lime is added first, any desired quantity of lime-cream may be added, and afterwards be neutralised by the gas; for, in this case, the gas combines with the free lime, instead of merely being dissolved in the juice. The practice of liming first therefore permits a larger precipitate of calcium sulphite per unit volume of juice, and this facilitates subsidence of the precipitated non-sugars, and the filtration of the sediments. The solubility of sulphur dioxide in juice is usually sufficient for effective chemical treatment, but the reverse order may be necessary when treating impure juices from inferior canes.

The following diagram shows four alternative methods of operating:—

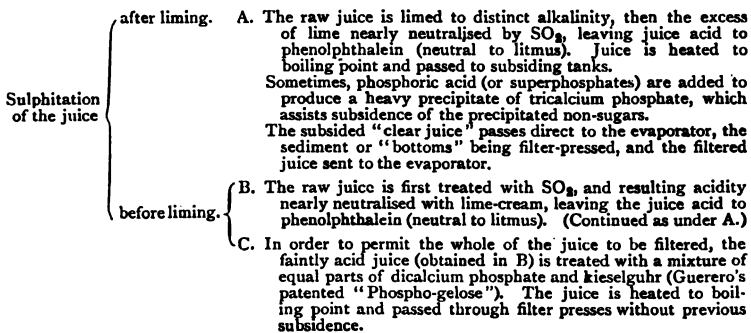

Sulphitation of syrup instead of juice.

D. *Back's Process.* The raw juice is clarified by lime alone (as in the "defecation process" for raw sugar) and then concentrated to syrup.

100 volumes of syrup are treated with from 2 to 2.5 volumes of lime-cream of 15° Beaumé, and finally with SO₂ gas until only faintly acid to phenolphthalein. Syrup is then passed through filter-presses and rendered transparent. Cakes left in presses are washed, first with clarified hot juice, and finally with water until they contain only from 2 to 3% sugar.

Further treatment of syrups obtained in methods A, B and C.

The cloudy syrups from juices treated by methods A and B cannot be filtered through cloth, but are heated strongly in open pans and run into subsiding tanks.

As the juice treated by method C has been filtered through cloth, the resulting syrup can also be filtered through cloth.

The clear syrups may be decolourised by one of the following methods:—

E. Filtration through bone-char. Or addition of decolourising carbons (Norit, Eponit, etc.) followed by filter-pressing.

F. Addition of hydrosulphites (Blankit, Rédo, etc.) in vacuum pan, at graining-point.

G. Treated with SO₂ gas at 70° C. until acidity of syrup = 1 to 1.5 grams SO₂ per litre.

Method A.—*Sulphitation after liming* has the advantage that a fixed volume of lime-cream is added per tank of juice, the final degree of acidity being controlled by the subsequent sulphitation. As apparatus for *continuous sulphitation* (p. 166) do not give sufficient control, it is better to adopt *intermittent sulphitation* (p. 167). The limed juice should be heated to 60° C., before sulphitation to ensure rapid absorption of the gas, and a granular (crystalline) precipitate of calcium sulphite, which favours rapid filtration of the sediments after subsidence. If the sulphitation be carried out cold, a part of the calcium sulphite is precipitated in the juice-heaters, forming a "scale" on the heating-surfaces, and may even choke up the tubes.

The quantity of lime-cream added per 1000 gallons of juice is mainly determined by the rate of subsidence (after sulphitation and heating), and by the firmness of the filter-press cakes (obtained on filter-pressing the sediments). In Java, the quantity of lime-cream added is about twice as much as in the *Defecation Process* (p. 179). Heavy liming is desirable in order to precipitate pectins, nitrogen compounds, anthocyan (if present), and as much of the gums as possible. After sulphitation, the acidity to phenolphthalein should be from 8.0 to 10.0 (see definition of acidity, p. 189). An experienced workman can regulate the sulphitation by the colour of the

juice when examined in a narrow test-tube. This final acidity is not due to free sulphur dioxide, but to organic acids (of much lower inverting power), which are liberated as shown below :—

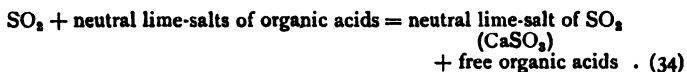

The faintly acid juice can therefore be heated to boiling point without fear of inverting sucrose.

Method B.—*Sulphitation before liming* has the advantage that *continuous sulphitation* can be employed ; namely, the *Sulphur Box*, or *Quarez System* (p. 166). Any variation in acidity (due to irregular absorption of the gas) can be subsequently corrected in the liming tanks. In this method, it is necessary to apply the gas to the *cold juice* since the acidity will rise to about 80, this being the maximum quantity of sulphur dioxide which the juice can absorb, and would cause loss of sucrose by inversion on heating even to 60° C. This acidity is reduced to from 8 to 10 by the addition of lime-cream, giving the same final acidity as in method A. If the lime used contains more than 1·0% of magnesia, the *titration is made at boiling point*; but, if the lime is almost free from magnesia, the acidity may be measured by *cold-titration*.

In both methods A and B, the lime-cream must be strained through fine wire-gauze to remove any small particles of unslaked lime, which would remain insoluble in the juice at the low temperature required for sulphitation and liming, but would pass into solution during the subsequent heating in the juice-heater ; thereby rendering the treated juice alkaline and dark in colour.

Heating the Juice.—As the Sulphitation Process is generally attended by the formation of “scale” in the juice-heater, the following methods are designed to minimise this difficulty, and to allow the juice to be sufficiently heated to ensure rapid subsidence of the precipitate :—

(1) The juice is first heated to 80° C. in juice-heaters (very little “scale” being formed at this temperature), and then brought to boiling point in open vessels, fitted with steam-

coils, or tubes. After boiling, the muddy juice is run off into subsiding tanks.

(2) Or, the final heating (above 80° C.) may be effected in steam-jacketed vessels (French Defecators), and heating stopped just at boiling point. The escaping air then causes the precipitate to rise to the surface as a "scum," which can be removed by skimming-ladles. Excellent white sugar is produced in Mauritius by this system of heating.

(3) Or, the juice-heaters may be designed on the principle of the superheater (p. 177); the juice flowing through the tubes at a high velocity, and passing backwards and forwards through different groups of tubes. This rapid motion reduces the deposition of "scale," but one "spare" heater is provided in order that each heater, in turn, may be put out of action, and cleaned.

Method C: "Phospho-gelose."—This is a new process which requires to be further tested on a factory scale. The use of Kieselguhr for producing a porous filter-press cake is not new (p. 205), but the cost of this material has hitherto retarded its application in the sugar factory.

Method D.—"Bach's Process" is another new process, which offers the following advantages over the present methods of sulphitation.

(1) The granular precipitate of calcium sulphite renders it possible to filter the treated syrup in filter-presses, thus obtaining perfect transparency before graining in the vacuum pan.

(2) Darkening of the juice during concentration to syrup is of no consequence since the bleaching agent is applied only to the syrup.

(3) Scale formation in juice-heaters and evaporators is minimised.

(4) The treatment of the juice being exactly the same as for raw sugar, the Bach Process is admirably adapted for factories producing either raw or white sugar, at different periods.

Methods E, F, and G are sometimes applied to the syrup after the juice has been treated by methods A, B, and C; and have been described in Chapter XVI (pp. 172–175).

Control Tests in the Acid-sulphitation Processes.—In the tests previously described for the *Neutral-sulphitation Process*

(p. 185), the neutralised juice gave a slight alkaline reaction on red-litmus-paper (due to soluble *neutral* sulphites). In the manufacture of white sugar by *acid-sulphitation*, the limed and sulphited juice should appear quite neutral to litmus-paper, in which case, it is really acid; the acidity being due to organic acids (see equation (34)). Whether liming precedes, or follows sulphitation, the relative proportions of alkali and acid are therefore adjusted so that the juice does not modify the violet colour of neutral-litmus-paper. This test is supplemented by the pale yellow colour of the transparent subsided juice (see *Settling Test* on p. 182). The factory chemist occasionally applies the more delicate *titration test*, in which 10 c.c. of juice are exactly neutralised with decinormal potassium hydroxide, using phenolphthalein as indicator. The volume of alkali required should be about 0·8 to 1·0, and the *acidity* (per 100 c.c. juice) is therefore from 8 to 10.

The Vivien Tube is a simple apparatus which enables the workman to measure the acidity of the juice himself, in less than one minute. It is a graduated glass tube, closed at one end, the other being closed by the thumb in order to quickly mix the contents by shaking. A pink solution ($\frac{N}{100}$ potassium hydroxide, coloured with phenolphthalein, and prepared by the factory chemist) is first poured into the tube exactly up to the zero mark of the graduated scale, then small quantities of the juice are added, with repeated shakings, until the pink colour of the mixture disappears. The volume of added juice is then read off, and is called the *Vivien degrees of acidity*; no calculation being required. The chemist orders the workman to keep the juice at, say, 9·5 *Vivien degrees*. Then, if a test shows 8·0°, this means that 8 volumes of juice contain as much acid as 9·5 volumes should contain, and the workman proceeds to reduce the sulphitation to give the required acidity.

(b) Carbonation Process for White Sugar

This method was designed and perfected in the beet-sugar industry, and is described in Chapter XIX. Chapters XVIII and XIX should be read before the following remarks, which

relate to certain modifications of the process, when treating cane juice.

Temperature.—Whereas beet juice is almost free from reducing sugars, cane juice may contain up to 20%, and therefore cannot be strongly heated in contact with free lime without darkening in colour. At temperatures below 55° C., the decomposition of the reducing sugars yields light-coloured products, chiefly lactic and saccharic acids, forming colourless, soluble lime-salts. At temperatures above 55° C., these salts decompose, yielding dark-coloured products, which are insoluble in alkaline juice, but freely soluble in neutral, or in acid juice. Hence, they can be separated from alkaline juice by filtration.

In order to prevent the formation of these dark-coloured compounds, the liming and carbonating are conducted at a maximum temperature of 55° C., when the juice contains about 10% reducing sugars; or at 45° C., when the juice contains about 20%.

The diagram on opposite page shows six alternative methods of carbonation. Detailed descriptions of these will be found in Geerligs' *Practical White Sugar Manufacture*.

Here, we shall only refer to a defect in most carbonation methods, and show how this has been overcome in De Haan's Process (method F).

The large quantity of lime-cream hitherto required (about 10 volumes per 100 volumes of juice) is not necessary to precipitate non-sugars by direct chemical action, but to form a copious granular precipitate of calcium carbonate, which mixes with the non-granular precipitate of non-sugars, forming a sufficiently porous mixture to permit of rapid filtration (p. 204). The effectiveness of the added lime is therefore proportional to the size of the particles of carbonate produced during carbonation.

When the gas is added to strongly alkaline juice (the ordinary method) a gelatinous precipitate of hydro-sucro-carbonate of lime is first formed, rendering the juice so viscid, that it froths excessively, and the gas is very imperfectly absorbed. This precipitate gradually decomposes with formation of calcium carbonate in a very finely divided

- Carbonation follows heavy liming
9-12 volumes of lime-cream per 100 volumes of juice.
- Temperature raised to boiling point causing complete decomposition of glucose.
- Temperature not exceeding 55° C.
(glucose not decomposed).
- Single Carbonation.
- Double Carbonation.
- Lime and CO₂ added together.
- A. Harloff's Process.** CaO neutralised by CO₂ in one operation, juice becoming faintly alkaline to phenolphthalein-paper. Precipitate separated by filtration. Slight alkalinity of filtrate (due to carbonates of potash and soda) is neutralised by SO₂, juice becoming neutral to litmus, but acid to phenolphthalein.
Advantage = less costly than "double carbonation" (method B).
- B. Original Process** designed for beet juice and modified for cane juice. CaO partially neutralised by CO₂, leaving juice with alkalinity of 0.4 gram CaO per litre. Precipitate separated by filtration. CaO in filtrate is neutralised by CO₂, leaving juice faintly alkaline to phenolphthalein. Precipitate removed by a second filtration. Final alkalinity in filtrate (due to carbonates of potash and soda) is neutralised by SO₂ (as in method A).
- C. Carbonation combined with sulphitation.** CaO partially neutralised by CO₂ + SO₂ added simultaneously, leaving juice with alkalinity of 0.4 gram CaO per litre.
(Continued as in method B.)
Advantage over method B = more granular precipitate, hence less lime required to ensure rapid filtration.
- D. Harloff's Process.** First carbonation and filtration as in method B. Remaining CaO neutralised by SO₂ (instead of CO₂) leaving juice neutral to litmus, but acid to phenolphthalein. Precipitate removed by filtration.
Advantages = fewer carbonation tanks and filter presses required than in methods B and C, also lighter-coloured juice and syrup. Smaller consumption of limestone and coke.
- E. Batellé's Process.** Juice is rendered strongly alkaline by addition of calcium saccharate (see below). Followed by double carbonation (as in method B) and sulphitation after concentration to syrup. Owing to complete destruction of glucose before carbonation begins there would be an increased loss of sugar in final molasses, but the sucrose is extracted from the molasses by Steffen's "Saccharate Process" and the extracted saccharate substituted for lime in the treatment of the juice.
Advantages = more thorough purification of juice, and higher yield of white sugar than in any other process.
- F. De Haan's Process.** Lime-cream and CO₂ gas are added to juice simultaneously, so that the alkalinity does not exceed 0.2 gram CaO per litre at any stage of the treatment. When sufficient lime has been added, the addition of CO₂ is continued until the whole of the free lime is neutralised.
(Continued as in method A.)
Advantages (see text).

Treatment of the Syrup. In all the above methods, the clear filtered juice becomes more or less cloudy after concentration to syrup. Hence, the syrup is filtered through cloth filters before entering the vacuum pan. The filtered syrup may be decolourised by methods E, F, and G referred to under "Sulphitation of juice."

condition, so that a larger bulk of this precipitate is required to produce a porous filter-press cake than if the carbonate were more granular in texture.

Method F: De Haan's Process.—The raw juice, previously

heated to 40°–50° C. in a juice-heater, enters the carbonation tank, where lime-cream and carbon dioxide gas are added *gradually and simultaneously*, in such proportions that the alkalinity of the juice is maintained between the limits of 0.25 and 0.30 grams CaO per litre. After the necessary quantity of lime-cream has been added, carbonation is continued until the alkalinity of the juice is fully neutralised, and the juice is then ready for filtration. In this mode of working, no hydro-sucro-carbonate of lime is formed; consequently, the juice does not froth, and the operation is completed in much less time, and with no loss of unabsorbed gas. The precipitated carbonate is granular, producing a porous cake. After filtration, the residual alkalinity (due to carbonates of potash and soda) is neutralised by sulphur dioxide gas until the juice becomes neutral to litmus, when it passes to the evaporator, without requiring a second carbonation, and second filtration (as in methods B to E).

The following advantages are claimed:—

(1) The reduction in limestone and coke consumed per 1000 tons of cane, is indicated in the following figures:—

	Double Carbonation (usual method)		De Haan's Process.	
	Limestone.	Coke.	Limestone.	Coke.
Factory A	46.00	4.67	23.15	1.80
„ B	42.24	3.65	23.82	2.43
„ C	46.04	3.96	22.56	2.12

(2) The total working cost is only slightly higher than that of the sulphitation process, but a superior quality of white sugar is obtained.

(3) As the juice cannot become strongly alkaline, decomposition of reducing sugars is avoided, the treated juice and resulting syrup being lighter in colour than when carbonation follows heavy liming.

(4) As frothing of the juice is avoided, the total capacity of the carbonation tanks is reduced by nearly 50%; the duration of the carbonation, and cost of filter-pressing being also reduced.

Sulphitation versus Carbonation

Working Cost.—The following costs per 1000 tons of cane, are taken from Geerligs' *Practical White Sugar Manufacture*, Part I, chapter 6.

Sulphitation	{	Materials used = lime, sulphur, filter-cloth	= £5 12 11
		Wages	= 1 16 10
			Total = £7 9 9
Double Carbonation	{	Materials used = limestone, coke, sulphur, filter-cloth =	£31 2 8
		Preparation of above for use	= 14 4
		Wages	= 6 3 5
			Total = £38 0 5

Single Carbonation by De Haan's Process, is about half the above.

In each case, *wages* only refer to those operations which differ in the two processes.

Loss of Sucrose per 100 Sucrose in Juice.—The following average losses in numerous Java factories, were calculated by Van der Want:—

	<i>Sulphitation.</i>	<i>Single Carbonation (De Haan's Process).</i>
During clarification of the juice	1'414	1'350
„ evaporation of water	0'675	0'810
„ clarification of syrup	0'064	0'014
Left in final molasses	8'710	8'030
	10'863	10'204

Advantages of Carbonation over Sulphitation.—

(1) Transparency of juice and syrup, resulting from filtration through cloth.

(2) Superior appearance of sugar (resulting from (1)) and permanency of appearance during storage and transport.

(3) Increased yield of sugar on 100 parts of sucrose in juice owing to lower viscosity of syrup and rich-molasses, resulting from the more thorough purification of the juice. This increased yield, and superior quality, almost compensate for the higher working-cost (relative to Sulphitation).

Advantages of Sulphitation over Carbonation.—

(1) More general applicability, because independent of a cheap supply of limestone. Lime, of suitable quality, being imported.

(2) Small initial cost of plant, and much lower working-costs.

(3) Requires much less manual labour, and less experienced workmen.

(4) Is much better adapted for factories which produce either raw, or white sugar, at different periods.

In conclusion, when a factory is intended to produce white sugar continuously, and suitable limestone is obtainable locally, the more efficient Carbonation Process (preferably De Haan's Process) may be adopted. But, when either raw sugar, or white sugar, is to be produced, some form of acid-sulphitation is adopted for white sugar, and the new Bach Process offers many advantages over the usual Sulphitation Process.

The foregoing account of the special treatment of cane juice in the manufacture of white sugar may be supplemented by reference to the following works:—

Geerligs' Practical White Sugar Manufacture.

Harloff and Schmidt's Plantation White Sugar Manufacture.

Maxwell's Sulphitation in White Sugar Manufacture.

CHAPTER XVIII

SEPARATION OF THE PRECIPITATE

THE chemical treatment of the juice is complete as soon as the chemical agents, and heat, have acted upon the non-sugars. The separation of the resulting precipitate is effected by one or more of the following mechanical means:—skimming, subsidence, filtration, and centrifugal separation.

METHOD (1): SKIMMING

When the juice is limed cold, or at a low temperature, and gradually heated just to boiling point, the contained (emulsified) air escapes in the form of minute bubbles, which adhere to the particles of the precipitate, carrying them to the surface, as a scum. This system is adopted in the *French Defecator* (p. 175), the scum being removed by means of skimming-ladles, leaving the underlying juice clear. Each Defecator in turn is filled with raw juice, limed, heated, skimmed, and discharged, thus operating intermittently. The principle of scum-formation is also adopted in the modern *Hatton Defecator*, but this apparatus operates continuously, the muddy juice entering at one point, and clear juice escaping at another point. A sectional diagram of this apparatus will be found in Scard and Jones's *Manufacture of Cane Sugar*, p. 149; and an exterior view on p. 151.

METHOD (2): SUBSIDENCE

On boiling the juice, immediately before, or after liming, all emulsified air is expelled; and the precipitated non-sugars, being somewhat denser than the juice, form a sediment at the bottom of the vessel, leaving the overlying juice clear. The latter can then be drawn off through a cock, placed above the

surface of the deposited sediment ; and the sediment can be afterwards drawn off through a second cock at the bottom of the vessel. The tanks employed for this purpose are termed *clarifiers*, or *subsiders*, and the time required for subsidence (in each tank) varies from 45 minutes to 2 hours, according to the quality of the juice, and the nature of the chemical treatment applied.

Each tank is filled, subsided, and emptied, in turn, and therefore operates intermittently. If the juice requires one hour for subsidence, the total capacity of the subsiders must be equal to the volume of juice extracted by the mill in one hour. But, since one subsider is always filling, and another discharging, two additional subsiders are required, and two " spare subsiders " may be added, so that the time allowed for subsidence may be extended beyond the normal period when treating inferior juice. The subsiders are usually rectangular, and arranged close together, in line. They are filled with juice from a horizontal juice-main, having branch-pipes and valves to each subsider. After subsidence, the clear juice from all the subsiders flows into a gutter extending along the line, and the sediments flow into a second gutter at a lower level.

Although the rate of subsidence mainly depends on the difference in density between the precipitate and the juice, it is greatly influenced by the following factors :—

(1) As the downward motion of the precipitate is retarded by friction with the liquid, a coarse (or flocculent) precipitate subsides more rapidly than a finely-divided precipitate, of equal composition and density.

(2) As the density and viscosity of the juice decrease with rise of temperature, a high temperature favours subsidence.

(3) Subsidence is retarded by convection currents, due to local cooling of the juice at its surface, and at the sides of the subsider. Surface-cooling is avoided in the *closed type* of subsider, and lateral-cooling may be minimised by lagging the exterior walls of the subsiders.

(4) When the density of the precipitate is only slightly higher than that of the liquid (juice), the rate of subsidence is influenced by the hydrostatic pressure of the liquid, at

increasing depths, because the liquid particles have less freedom of motion near the bottom of the subsider than near the surface of the juice. Consequently, the subsider should not be very deep when subsidence is very slow.

Instead of subsiding the juice for a fixed period in separate tanks, various forms of *continuous subsiders* are used, one of which will be described here.

The *Deming Continuous Subsider* is a large, cylindrical, vertical tank, with conical bottom terminating in a cock. Within the cylindrical portion is suspended a second cylinder, the diameter of which increases from top to bottom, and which is open at bottom. Both cylinders are closed at top by a single dome-shaped cover, having several inlets for muddy juice round the circumference, also an outlet for clear juice at the centre.

When starting the apparatus, it is completely filled with muddy juice, the inlets closed, and the contents left undisturbed until the inner cylinder (or cone) contains clear juice. From this stage onwards, a continuous feed of muddy juice enters between the interior and exterior cylinders, passing downwards at increasing velocity (caused by the diminishing space between the two cylinders) until it reaches the open bottom of the interior cylinder. Here the liquid moves very slowly upwards towards the outlet at top, but the inertia of the solid matters (precipitate) causes them to descend into the conical bottom of the outer cylinder. Any particles carried upwards by the juice adhere to the sloping surface of the interior cylinder, whence they gravitate back to the sediment below. The latter is drawn off from time to time through the cock at the bottom of the apparatus, and sent to the filter-presses.

It is usual to pass the juice through two of these subsiders, *arranged in series*. Or, the semi-transparent juice leaving the first subsider, may pass through two similar subsiders, *arranged in parallel*, the rate of flow in these being only half of that in the first. This apparatus is illustrated in Deerr's *Cane Sugar*, p. 258.

METHOD (3): FILTRATION

General Principles

The filtering agent (usually cloth) contains minute apertures, or pores, which are smaller than the solid particles to be separated, but allow a free passage for the liquid. The solid particles therefore collect on one side of the filter-cloth, forming a layer which gradually increases in thickness; and clear liquid escapes from the opposite surface of the cloth. The rate of filtration *per unit area of filtering-surface* depends on the following four factors:—(1) porosity of the filtering medium (cloth, sand, etc.); (2) porosity of the solid matters, separated from the liquid; (3) viscosity of the liquid treated; and (4) pressure applied to the liquid during filtration. Each of these factors is modified by secondary factors, as follows:—

(1) *Porosity of the Filtering Medium.*—In the case of cloth, this is determined by its texture and thickness. When the filtering agent is sand, or similar loose material, the porosity depends on the size and shape of the individual grains, since this determines the sizes of the small spaces, or channels, between the grains.

(2) *Porosity of the Solid Matter separated from the Liquid.*—If this solid matter be crystalline, or granular, it is composed of rigid particles, having definite forms, and which can only come into contact at certain points, leaving minute spaces at other points. The deposit on the filter-cloth is therefore porous, and its porosity increases with the size of the individual particles composing it. The organic non-sugars, precipitated from cane- and beet-juices by the action of lime, are composed of soft, gelatinous particles, which readily cohere; forming a non-porous layer or deposit, which retards filtration, and may even arrest it.

(3) *Viscosity of the Liquid.*—This depends on the nature of the dissolved solid matters; and increases with the concentration, or density of the liquid, and decreases with rise of temperature.

(4) *Pressure applied to the Liquid.*—When the solid particles to be separated are crystalline, or granular, the rate of filtration is directly proportional to the square of the pressure

applied, and is inversely proportional to the thickness of the layer of solid matter thus separated. It is here assumed that the pressure acts on the liquid, without modifying the texture of the deposited solids, through which the liquid is forced. But, when the solid particles are soft and easily compressed, the pressure acts simultaneously on the deposited solids and on the liquid, reducing the porosity of the former, and thus counteracting the advantage due to pressure acting on the liquid. If the pressure be excessive, the soft particles may be forced into the pores of the filter-cloth, making matters worse ; or, may even be forced through the cloth, causing the filtered liquid to be cloudy.

Aids to Filtration

The filtration of a liquid containing soft particles in suspension (cane- and beet-juices) may be greatly facilitated by the addition of an insoluble, granular substance, such as kieselguhr ; or, crystalline substances, such as sulphate, sulphite, and carbonate of lime. The soft particles are thus blended with a sufficient quantity of the added hard particles to produce a semi-porous mixture, when deposited upon the filter-cloth. This method is adopted in the *Carbonation Process* of purifying beet juice, to be described in the following chapter, wherein calcium carbonate is the agent employed to assist filtration.

Kieselguhr has been recently employed to facilitate the filtration of cane juice, after the non-sugars have been precipitated by lime. It consists of silicious skeletons of minute organisms—*diatoms*—which abound in fresh-water lakes. The dead diatoms sink and form large deposits, which eventually decompose, leaving skeletons of similar form, but containing from 90 to 95% pure silica in the dried state. To the naked eye, kieselguhr is a fine powder, having a grey or reddish tint. Viewed with the microscope, the individual grains are of different forms—circular, oval, needle-shaped, etc. ; and also vary greatly in size, according to the variety of diatom. The porosity of the substance is indicated by the fact that one cubic foot weighs only 12 pounds ; the same volume of fine sand weighing about 100 pounds. It is

used as an absorbent for nitro-glycerin in the manufacture of dynamite ; also, as a non-conducting lagging for boilers, and steam-pipes. Deposits of kieselguhr are found in many countries, the needle-shaped variety being the most suitable for assisting filtration.

The quantity added to cane juice should be sufficient to produce a firm "cake" in the filter-press. Factory experiments, made by Fribourg, indicate the proportion of 2.5 kilos. of kieselguhr per 1000 litres of juice (25 pounds per 1000 gallons). The dry powder is first stirred with clean water to a thick cream, strained through a sieve (30 mesh per inch), and the lumps retained on sieve broken up by hand until all passes through. The strained material is stored in a tank, from which measured portions are drawn off and added to the juice, as required. The stock must be thoroughly mixed (preferably by mechanical stirring-gear) in order to keep the kieselguhr in suspension. A second "mixer" is required when adding the material to the juice, immediately before filtration.

Fibre.—In certain industries, sawdust has been employed for facilitating filtration of soft precipitates, and also as a filtering-medium. Finely-divided cane fibre (*cush-cush*) acts in the same manner, modifying the texture of the deposited solid matters, and rendering them more porous.

Raw cane juice always contains fibre in suspension, hence the precipitated organic non-sugars are blended with harder particles of fibre. The rate of filtration is sometimes increased by allowing more fibre to pass into the juice (and finally into the filters) by employing a coarser juice-strainer at the mill. But, even then, filtration is too slow to permit the whole of the juice to be filtered, without employing an excessive number of filters. The less costly method of subsidence is generally adopted in the cane-sugar factory ; from three-quarters to four-fifths of the total juice being thus clarified, leaving only one-quarter, or one-fifth, as *sediment* to be filtered.

As beet juice contains very little fibre in suspension, the precipitated organic non-sugars would form a non-porous layer in the filter, unless blended with some granular material, such as calcium carbonate.

Stages of Filtration in the Sugar Factory

Filtration is employed at one or more of the following stages :—

(1) *Semi-transparent Cane Juice*, after the precipitate has been allowed to subside. As subsided-juice is never quite free from solid matters in suspension, filtration is sometimes adopted in the manufacture of white sugar, but not in the case of raw sugar.

(2) *Sediments, Scums, or Bottoms, from Cane Juice*.—As these contain a large proportion of juice mixed with the precipitate, the sediments from all the *subsiders* are collected in a second set of tanks, where they are boiled, re-subsided for an hour, and then yield about half their volume of clear juice. The second sediments are filtered in order to extract the residual juice.

(3) *Total Juice, without Subsidence*.—This is the standard method for beet juice in the Carbonation Process (see following chapter). It is also applicable to cane juice when treated by the same process, or by the addition of kieselguhr, without *carbonation*.

(4) *After Concentration of the Juice to Syrup*.—During evaporation of water from cane- and beet-juices, certain mineral constituents become insoluble, and are partly deposited as "scale" on the metal heating-surface of the evaporator, the remainder being suspended in the syrup. Consequently, a perfectly transparent juice generally yields a turbid syrup.

In the foregoing stages, the quantity of solid matter to be removed by filtration, per hundred parts of liquid, varies very greatly; being exceedingly small in stages (1) and (4), and relatively large in stages (2) and (3). Hence, different types of filters are used at different stages, as outlined below.

Types of Filters Employed

(1) Filters for removing very small quantities of solid matters from semi-transparent juice are termed *Juice Filters*, or *Mechanical Filters*, and operate for a considerable time without requiring to be cleaned. This class includes :—(a) wire-gauze filters, (b) cloth filters, (c) sand filters (including

gravel, and similar materials), and (a) fibre filters (including bagasse, palm-fibre, etc.).

(2) and (3) Filters for removing large quantities of solid matters from juice-sediments are termed *Scum-filters*, (although the filtered liquid is juice) and operate for short periods, because the solid matters accumulate in the form of "cake," and require to be discharged from time to time. This type of filter is adapted for the following operations:—filtration of juice, with formation of a "cake" of solid matters; washing this "cake" with water to remove the juice, and avoid loss of sugar; and discharging the "cake," with as little manual labour as possible.

Two types of scum-filter are employed, namely:—(a) the Filter-press, and (b) the Leaf-filter.

(4) Syrup Filters, which include (a) Cloth Leaf-filters, and (b) Sand-filters.

(5) To make this list complete, we may include the Sugar Centrifugal (described in Chapter XXV). This apparatus is a wire-gauze filter, for separating sugar crystals from syrup, or from molasses.

(1) *Filters for Semi-transparent Juice* (*Juice Filters*)

(a) *Wire-gauze*.—The ordinary "*cush-cush strainer*," for raw mill juice, cannot be termed a filter because the strained juice contains a large amount of solid matters in suspension, and is quite opaque. A wire-gauze filter of much finer mesh is used for separating any flocculent particles which may be present in the subsided juice, owing to incomplete subsidence, or to carelessness in decanting the subsided juice from the underlying sediment. This gauze cannot remove the finest particles in suspension, but acts as a "corrective" after subsidence and decantation.

The filter is constructed of bronze-wire gauze, having 2000 mesh per square centimetre (as used for "bolting" flour). The gauze is fastened to a rectangular wooden frame, forming a sieve; a coarser strainer of stout wire being added as a support for the gauze. The semi-transparent juice (flowing from the subsiders) passes through the gauze-filter into the

juice-supply-tank of the multiple-effect evaporator. The solid particles, retained on the gauze, are removed periodically. Geerligs gives the following analysis of this material, after being dried:—

Organic matter (including fibre)	95·6%
Mineral matter (ash)	4·4%
	100·0%

(b) *Cloth Filters*.—Semi-transparent juice is more efficiently filtered by means of cloth, in *Bag-filters* and *Leaf-filters*.

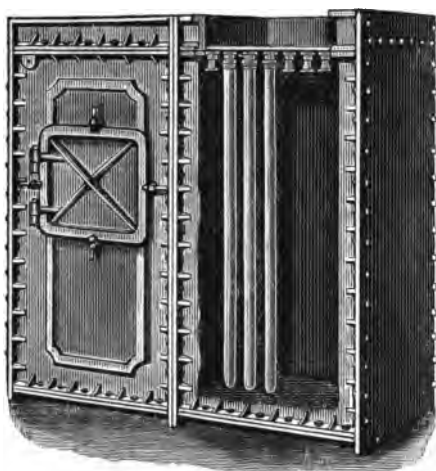

FIG. 18.—TAYLOR BAG-FILTER

From Thorpe's *Dictionary of Applied Chemistry* (Longmans & Co.)

In the former, filtration proceeds from inside to the exterior of the cloth bags; whilst, in the latter, filtration proceeds from the exterior to the interior of perforated metal chambers, covered with cloth.

The *Bag-filter*, or *Taylor Filter* (Fig. 18), consists of a rectangular cast-iron chamber, divided into two compartments by a horizontal perforated plate. The upper compartment is about 18 inches high, and the lower one about 7 feet. Each perforation of the plate is fitted with a gun-metal socket, with internal screw-thread, to receive detachable

gun-metal cones, or nipples. To every cone is fastened the open mouth of a cylindrical bag, or "*stocking*," of twilled cotton, about 6 feet in length, and 4 inches in diameter. The cones are then screwed into the sockets on the perforated plate, the bags hanging vertically from the lower surface of the plate, with their closed ends a few inches above the floor of the chamber; one chamber containing from 25 to 100 bags. Man-hole doors are provided in the front of the chamber, for attaching and removing the bags.

The juice to be filtered enters the upper compartment, flowing thence into the numerous bags and filling them completely. Filtration proceeds under moderate pressure due to the head of liquid above the bags; the clear juice flowing down the exterior surface of each bag, and falling to the floor of the chamber, whence it escapes through an outlet pipe. Filtration is assisted by filling the lower chamber with steam. The separated solid matters collect in the interior of the bags, forming a sludge, which gradually retards filtration, and must therefore be removed periodically. Clean bags, attached to cones, are kept in readiness, and screwed into position as soon as the soiled bags are removed. Bags of 3 feet circumference, folded lengthwise, and inserted in cotton-sheaths of 4 inches diameter, are frequently used in order to increase the filtering-area per bag.

The *Leaf-filter* differs from the *Bag-filter* in two respects, namely, the form of the filter bags, and the direction in which filtration proceeds. One of the best designs is the *Philippe Filter*, consisting of a number of filtering-chambers, or "leaves," arranged vertically within a cast-iron casing. Each chamber consists of a flat, rectangular wire frame, over which is stretched a bag of filter-cloth, the frame serving as a support to the cloth, when subjected to moderate external pressure. The unfiltered juice fills the interior of the cast-iron casing, and consequently surrounds the numerous filtering chambers. Filtration proceeds through the cloths into the shallow spaces occupied by the wire frames, moderate pressure being applied, either by means of a feed-pump, or by gravitation from an overhead supply-tank. The filtered juice overflows from the chambers through suitable outlets

at top, and is caught in a gutter. The solid matters remain outside the chambers, in direct contact with the mass of unfiltered juice, and gravitate to the bottom of the cast-iron casing, whence they are drawn off from time to time and separated from the juice in *Scum-filters*.

One Philippe Filter contains from 20 to 30 filtering chambers, or *leaves*, each of which has about $10\frac{1}{2}$ sq. ft. of filtering-surface. When working under a head of 6 feet, the rate of filtration is about 10 gallons per square foot of cloth, per hour.

(c) *Sand-filters*.—In this case, the filtering-surface is proportional, not only to the surface-area, but also to the depth, or thickness, of the layer of sand. The muddy juice penetrates the uppermost layers before it becomes transparent; and the lowermost layers may remain perfectly clean, after the surface layers have become fouled with the deposited solid matters. Sand-filters can therefore operate for long periods without requiring attention, and the sand can be washed clean by a strong current of water (generally in the filter itself) so as to be used repeatedly. The sand must have a suitable texture, and as there is a certain wastage during washing, the cost of sand becomes appreciable.

Geerligs gives the following analysis of the dry solid matters separated from the subsided juice in a sand filter:—

Cane Fibre	69.1%
Albuminoids	6.9%
Wax	7.7%
Ash	16.3%
	<hr/>
	100.0%

The ash consists of:—

Calcium silicate	5.0
,, phosphate	8.8
,, carbonate	2.2
Undetermined	0.3
	<hr/>
	16.3

The numerous designs of sand-filters differ mainly in the arrangement of the sand-bed, the direction in which the juice flows through the bed, and in the method of cleaning the sand, after it has become fouled.

Horizontal Sand-bed (open type).—This is a cylindrical tank, having a horizontal perforated shelf near the bottom. The upper surface of the shelf is covered with a sheet of bronze-wire gauze, which supports the sand-bed. Filtration proceeds downwards, under moderate pressure due to the head of juice above the sand, the tank being kept full of juice by means of an overflow device. When the sand becomes fouled, it is washed by an upward current of water passing through the sand-bed, whilst the sand is kept in motion by a number of vertical stirring-rods attached to a rotating shaft. The muddy wash-water escapes through an outlet just above the sand-bed.

The same arrangement is adopted in the *closed type* of filter, which has the advantage that a single pump forces the muddy juice into the filter, and elevates the filtered juice to a higher level, if desired.

Breitfeld and Danek Sand-filter.—This is similar to the above, but the sand is washed by means of water-injectors.

Abraham's Sand-filter is a vertical, cylindrical vessel, about 6 feet in height, and 2 feet in diameter, having a central cylinder of perforated metal, about 8 inches in diameter, and covered with fine wire gauze. The interior cylinder carries a large number of conical rings (2 feet diameter, and 3 inches deep) arranged one above another. The larger diameter of each ring is uppermost, and nearly touches the outer cylinder; the lowermost ring rests upon a supporting flange, near the base of the outer cylinder. The space between the rings and the central cylinder is completely filled with sand. Unfiltered juice enters near the bottom of the outer cylinder, fills the shallow space surrounding the rings, passes horizontally through the sand, thence through the wire-gauze into the central cylinder, finally escaping through an outlet below. When the sand becomes fouled, it is discharged through a door at bottom, and washed in a separate vessel. Two filters (of above dimensions) can treat 1000 gallons of subsided semi-transparent juice per hour, and only require cleaning at long intervals.

(d) *Bagasse Filters.*—Well-crushed bagasse is an excellent filtering medium, and costs nothing. The bagasse-bed is

usually supported on a perforated plate, covered by a sheet of filter-cloth (to hold back any fine particles of bagasse). Upward filtration is preferable, in order to prevent the bagasse from "packing" too closely, and also to ensure that the bagasse is completely submerged in juice, and free from air-pockets. When the bagasse becomes charged with the deposited solid matters, it is recrushed in the cane mill in order to extract the absorbed juice, thereby dispensing with the wash-water required for sand filters. The transport of the bagasse from the mill to the filters, and from the latter back to the mill, necessitates mechanical *transporters*, and increases the initial cost of the filtering plant.

The *Gartley Bagasse-Filter* has proved very successful for treating subsided juice before it enters the multiple-effect evaporator.

Illustrations of the various filters described above will be found in the following works:—

Ware's *Beet Sugar Manufacture and Refining*, 1905,
Part III, chapter 6.

Deerr's *Cane Sugar*, chapter 15.

Bühler's *Filters and Filter Presses*. Translated and enlarged
by Eastick, 1914, pp. 123-145.

(2) and (3) *Filters for Muddy Juice*
(*Scum-filters*)

(a) *The Filter-press*

The name of this apparatus is misleading, for the "Press" is a mechanical device for holding the separate parts of the filter together, and has no action on the juice, or other liquid, being treated.

The apparatus consists of a large number of shallow filtering chambers, arranged in line, like books on a shelf. A single chamber consists of a rectangular metal frame (about 1 inch thick), the opposite flat surfaces of which are in close contact with two filter cloths, of same dimensions as the frame itself. The open area enclosed by the frame \times thickness of frame = capacity of filtering chamber, which is filled with

the muddy juice, as explained below. Filtered juice escapes from the enclosed chamber by flowing (in opposite directions) through the two cloths, and is received on two grooved plates (exterior to each cloth), whence it gravitates to an outlet-cock at the bottom of each grooved plate.

A "unit" of the filter-press therefore comprises—1 frame 2 cloths, and 2 grooved plates. But, as each plate is grooved on opposite sides, it receives filtered juice from chambers on either side of it, so that any number of similar "units" are formed by adding alternate frames and plates, separated by cloths. One filter press may contain 50 frames (49 plates); but large presses, containing 160 frames (159 plates), have been employed in beet-sugar factories.

An exterior view is shown in Fig. 19. Two rigid vertical supports are connected by two horizontal beams, or stay-bars, upon which the numerous frames and plates are suspended, and supported, by means of projecting lugs. These lugs slide horizontally along the stay-bars, thus permitting the plates and frames to be separated (for discharging the cakes and renewing the cloths), or to be brought into close contact when the filter is ready to operate. At one extremity (on the right in Fig. 19) is a rigid and massive *head-plate*, grooved on one side only. At the opposite extremity is a massive *tail-plate*, resembling the *head-plate*, but moving towards the latter, under the action of the screw (on left) when the press is closed for action. This *tail-plate*, one frame, and one grooved plate are shown slightly separated; the remaining frames and plates being in close contact. The outlet-cocks, through which the filtered juice escapes from the side-edge of each grooved plate, are shown in line above the filtered-juice-gutter. When the press is closed, and ready to operate, the edges of all the filter-cloths are gripped between the flat edges of the plates and frames, forming water-tight connections.

Inlet for Muddy Juice.—A pump is connected by piping to an inlet-valve on the *head-plate*, and every plate and frame carries a projecting *ear* or *flap* with a large hole, in line with this inlet-valve (such holes being visible in Fig. 19). When the press is closed by the screw, the separate holes in frames

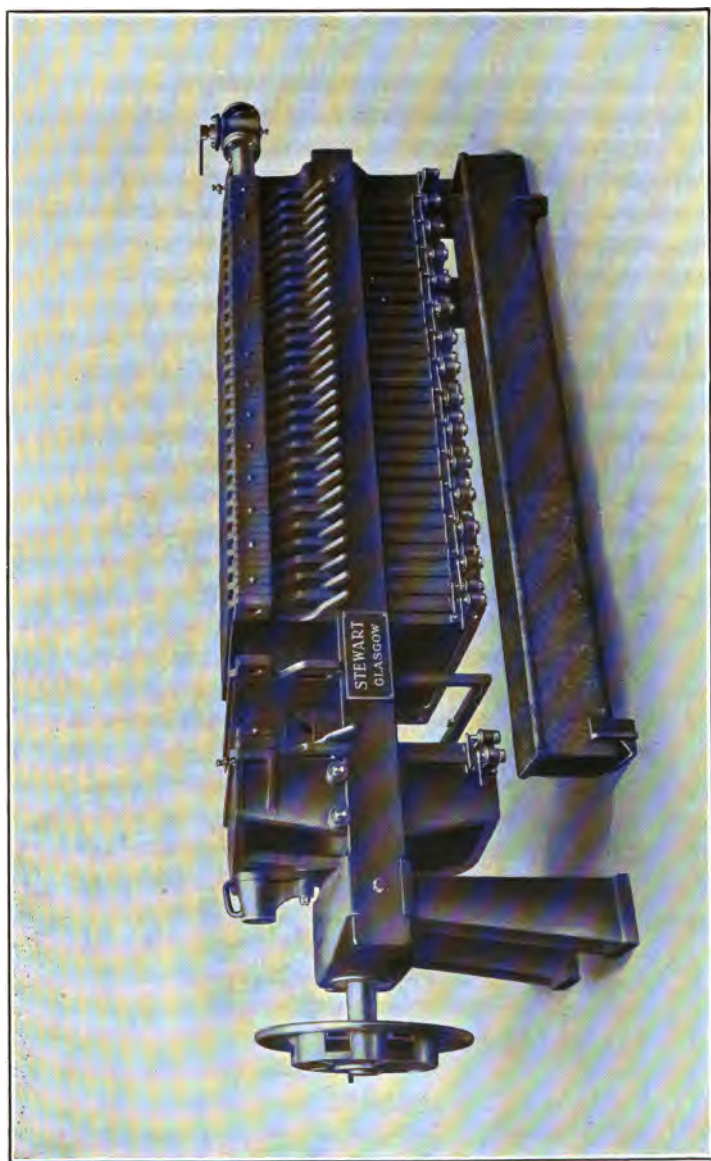

FIG. 19. FILTER-PRESS (partly opened).



and plates unite to form a continuous channel, extending horizontally from the *head-plate* to the last frame. The muddy juice flows along this channel and enters every filtering-

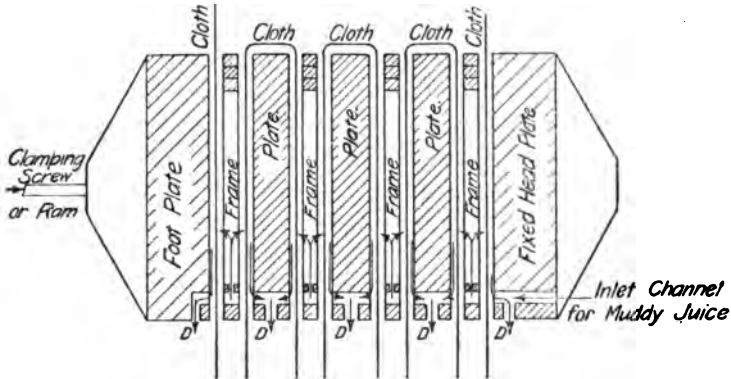

FIG. 20.—FLOW OF JUICE DURING FILTRATION

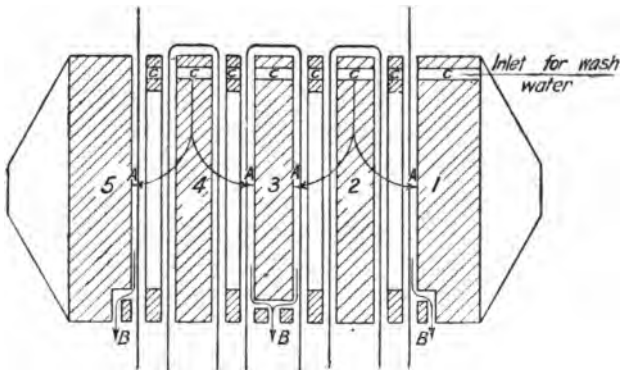

FIG. 21.—FLOW OF WATER DURING WASHING.
DETAILS OF FILTER-PRESS

chamber through slots cut in each frame (at right angles to the main channel), thus filling every chamber simultaneously.

Fig. 20 represents a vertical section through 4 frames and 3 plates (slightly separated for clearness). The muddy-juice-inlet is here shown in one of the lower corners, the continuous channel passing through the frames and plates, but is here shown in the *frames* only. A second channel, with outlets

D, D, is cut *in the opposite corner of each plate*. The passage of the juice from the inlet-channel into each frame is indicated by the upward arrows.

Outlet for Filtered Juice.—Each filter-cloth has one surface in contact with the muddy juice (enclosed in the filtering chamber), and the opposite surface in contact with the projecting ridges on the following grooved plate. The hollows between these ridges allow the filtered juice to gravitate (see downward arrows) to the second channel on the opposite side of plate to the inlet-channel; the filtered juice escaping at D, through outlet-cocks shown in Fig. 19.

Formation of Cakes.—The solid matters separated from the juice accumulate in the numerous filtering chambers, eventually filling these completely. Hence, the cakes exactly fill the rectangular openings in the frames, being of the same thickness as the metal forming the frame. The firmness of the cake depends on its porosity, and the pressure applied by the juice-pump, or *mont-jus*, during filtration.

Washing the Cakes.—When the chambers become filled with cake the juice-inlet-cock is closed, and another inlet-cock for water, is opened. In Fig. 21, this water-inlet is shown in an upper corner of frames and plates, forming a continuous channel C, C, C. From this channel the water enters every *alternate plate*, namely, 2 and 4. From opposite surfaces of plate 2, it flows in opposite directions, through 4 cloths, 2 cakes, and reaches the grooved plates 1 and 3, whence it escapes through the attached outlet-cocks. Similarly, from opposite surfaces of plate 4, the wash-water flows (in opposite directions) through 4 cloths, 2 cakes, and reaches the grooved plates 3 and 5. The washing is continued until the density of the escaping washings is reduced to 1° or 2° Brix.

When the cakes are insufficiently porous to permit of washing, steam is forced through the juice-inlet channel (or through a separate steam-channel) in order to drive out the residual juice.

Discharging the Cakes.—The clamping-screw is reversed, causing the massive tail-plate to move backwards, so that the frames and plates can be separated horizontally (with-

out lifting them), and the cakes fall into a receptacle below.

Double Filtration.—A much more efficient method of washing consists in discharging the cakes into a mechanical mixer (placed below the filter-press), and stirring them with sufficient hot water until reduced to a thin cream, or sludge. The latter is then pumped into a second set of filter-presses, to remove the added wash-water, after which the cakes are discharged.

Feeding the Filter-press.—The best method of applying pressure to the juice during filtration is by means of a feed-tank raised about 20 feet above the filter-presses. A centrifugal pump, directly connected to the filter-presses, is equally satisfactory and sometimes more convenient than the overhead feed-tank. A reciprocating pump is objectionable when directly connected to the filters, because the pressure is intermittent, instead of continuous; but such pumps serve to raise the muddy juice to the overhead feed-tank. The "*mont-jus*," although still frequently used, is objectionable on account of the high temperature of the steam used, causing decomposition and darkening of the juice.

The Filter-press was first introduced into the sugar industry by Needham and Kite in 1856, and the frame-and-plate press was designed by Jacquier and Danek in 1864. The apparatus has since undergone numerous improvements, some of which may be briefly described.

Dehne's Filter-press.—The channels for muddy juice, water, and steam, are bored through metal *ears* or *flaps*, projecting beyond the edges of the frames and plates, and, therefore, outside the area covered by the filter-cloths. The latter do not require "channel-holes" cut in them, therefore they last longer, and can be placed in position more rapidly than cloths having channel-holes.

When the filter-press is closed for action all the projecting *flaps* come into line, and are connected by water-tight joints, thus forming continuous channels from end to end of the filter-press. These joints are formed in two ways, namely:—
(a) by small *cuffs* of filter-cloth, fitting over the *flap*, and having corresponding holes on each side of the *flap*; or,

(b) by means of rubber rings, held in counter-sunk sockets on the flaps.

Fohebur Filter-press.—In the older forms of filter-press, the cloths are frequently forced between the ridges, or ribs, on the plates, thereby obstructing the channels for the escaping filtered juice. This defect is usually remedied by interposing perforated metal screens between each filter-cloth and ribbed plate, as is done in the Fohebur Filter-press. A novel feature of this filter is that the filtered juice, on opposite sides of any one plate, drains into separate outlets, on opposite edges of the plate (hence, on opposite sides of the filter-press). Consequently, if a cloth on one side of the plate be defective, the cloudy juice can be shut off, without shutting off the juice filtering on to the same plate, from the opposite filter-cloth. This double outlet renders filtration and washing of the cakes so rapid that it becomes possible to produce very thick cakes, by employing frames of 4 inches depth (*i. e.* of metal 4 inches thick), which reduces the area of filter-cloth required per ton of "cake" formed.

The muddy juice enters by two independent channels, cut in the two upper corners of the frames and plates. One of these channels serves as an air-vent, when starting work, also, for admitting compressed air, or steam, for "drying" the cakes before they are discharged.

The filtered juice does not pass from the plates into a gutter, but flows through two parallel channels, cut in the two lower corners of the plates and frames, to an outlet in the rigid head-plate of the filter. Before the filtered juice enters these channels, it flows through a cock and short glass tube projecting from (and returning back to) each plate. The glass tubes (or "sight-glasses") enable a leaking filter-cloth to be instantly detected, and the corresponding cock closed. The absence of the usual open gutter enables the workmen to stand close up to the press, when discharging and cleaning it, also prevents loss of heat by exposure to the air, and darkening of the juice by oxidation.

These two internal channels for filtered juice are each connected externally, to two branch-pipes; one leading to the receiver for filtered juice, and the other to the water

supply. When the filter-press is in action, both channels discharge the filtered juice into the receiving tank, but when the cakes are to be washed, either one, or both channels can be used as a water-inlet, the water then passing through the filter-cloths in a reverse direction to the juice during filtration.

In order to economise manual labour in handling the press, the frames and plates are of large size, and mounted on rollers, so as to move easily on the horizontal supporting-bars. The greater depth of the frames reduces the number of frames and plates to be handled per ton of cake formed.

The press is closed, or clamped, by a hydraulic ram, instead of a screw. When the required pressure is attained, the ram is mechanically locked in position, so that hydraulic pressure does not require to be maintained during filtration. One of these filter-presses has 800 sq. ft. of filtering surface, and discharges from 3 to $4\frac{1}{2}$ tons of cake. The quantity of filter-cloth required per ton of cake is only about 25% of that required by the older filter-presses, producing cakes of from 1 to $1\frac{1}{2}$ inches in thickness.

(b) *The Leaf-filter*

As much manual labour is required to operate a battery of filter-presses, attempts have been made to construct filters which can be opened and discharged automatically. Two successful American designs are known as the *Kelly* and *Sweetland* Filter-presses, but are more correctly described as *Leaf-filters*, being constructed on the principle of the Philippe Filter (see above). They differ from it in producing *cakes* of the separated solid matters, and means are provided for discharging these cakes.

The Kelly Filter.—The filtering chambers, or “leaves,” are enclosed in a strong, cylindrical, horizontal body, with detachable cover at one extremity. Each “leaf” consists of a rectangular frame of wire, or corrugated metal, enveloped in a closely-fitting bag of filter-cloth. Ten “leaves,” set 4 inches apart, are arranged within the cylindrical body, parallel to its axis; the leaves being all of equal length (horizontally), but varying in height, so as to conform to the circular cross-

section of the cylindrical container, or body. The ten "leaves" collectively represent 40 square metres (430 sq. ft.) of filtering-surface, the flat filtering-surfaces being arranged vertically, and parallel to each other.

The muddy juice is pumped into the cylindrical body, and surrounds the "leaves," or filtering chambers. Filtered juice penetrates the cloths, and thus reaches the interior of each "leaf," whence a small pipe conducts it to a cock fixed outside the detachable cover of the filter. The ten outlet-cocks (one for each "leaf") are arranged in line, and discharge the filtered juice into a gutter (also attached to the cover of the filter).

The solid matters separated from the juice, accumulate between the leaves, forming cakes. In order to discharge these cakes, the detachable cover of the cylinder, and the attached leaves, are mounted on a *carriage* running on wheels, and moving along the axis of the cylinder. As this axis slopes slightly from the horizontal, the carriage (when loaded with "cake") moves down the inclined rails by gravity, until the "leaves" emerge completely from the cylindrical body. The cakes can then be detached from between the leaves, and fall into a receptacle below. After the cakes are discharged, counterpoise-weights draw the empty *carriage* back into the cylinder, the cover thus returning to its normal position at the end of the cylinder. A water-tight connection is produced by moving a single lever, and the filter is again ready for action.

To assist in discharging the cakes, compressed air, or steam, can be admitted to the interior of the "leaves," to detach the cakes from the cloths. The cloth bags are not removed from the supporting frames until worn out, and as the cloths are subjected to very little wear and tear, one set has been used for an entire crop season.

Various methods are adopted for cleaning the cloths *in situ*. For example, the empty filter is closed, and hot water forced into the "leaves" under pressure, passing through the cloths (from inside to outside), thus clearing the pores of the cloth, and washing the exterior surfaces.

In a Californian beet-sugar factory, treating 900 tons of

beets per day, the whole of the *carbonated juice* is filtered twice in ten Kelly Filters, operated by only four men per shift, or eight men in twenty-four hours. After filtration is stopped, and the cakes have been washed, it requires only twelve minutes to open the filter, discharge the cakes, close the filter, and restart filtration.

When filtering *defecation* and *sulphitation* scums from cane juice, the cakes adhere so firmly to the "leaves" that difficulty may be experienced in discharging them. Even when treating the much heavier *carbonation scums*, one beet-sugar factory employs a powerful jet of water to detach the cakes. This is a very objectionable method, in view of the fact that the cakes (from both cane and beet) are utilised as fertilisers, and can only be applied in a semi-dry condition.

The Sweetland Filter.—This differs from the *Kelly Filter* in having circular "leaves," of uniform size, arranged at right angles to the axis of the enclosing cylindrical body. The latter is truly horizontal, and the flat filtering-surfaces of the leaves are vertical.

The muddy juice enters the cylindrical body by a pipe extending along the top, and having branch-pipes entering the cylindrical body at points mid-way between each pair of leaves. Filtration proceeds through the cloths to the interior of each leaf (as in the *Kelly Filter*), but the filtered juice escapes at the top of each leaf, by means of a short, vertical pipe, which also holds the leaf in position. A short glass tube connects this outlet to a larger metal pipe, extending horizontally above the top of the filter. The glass tubes show whether the filtered juice (from each leaf) is transparent; if not, a cock on the outlet of the defective leaf is closed. The metal pipe (to which all the outlet-cocks are connected) takes the place of the open gutter in the ordinary filter-press; and corresponds to the internal channel for filtered juice, in the *Fohebur Filter-press*. It prevents oxidation and cooling of the filtered juice.

During filtration, the circular areas between the leaves gradually fill with accumulated solid matters, forming circular cakes attached to the cloths. When adjacent cakes approach

within half-an-inch of each other, filtration is arrested by shutting off the supply of juice, and wash-water is then admitted through the same inlets.

The cylindrical body of the filter is composed of two semi-cylindrical steel castings. The upper one is rigid, and supported on uprights, the lower one is hinged, and can be swung open, but forms a water-tight connection with the upper casting, when the filter is closed. The motion of the lower portion is effected by levers, actuated by two hydraulic rams (one at either extremity of the filter), these two rams being operated by a single hand-lever. When the lower half of the vessel is swung open, the cakes fall vertically into a receptacle below. Compressed air can be admitted to the interior of the "leaves," to assist in detaching the cakes from the cloths. The hand-lever is then reversed, and the hydraulic rams bring the lower half of the cylinder back into its normal position, and simultaneously produce a water-tight connection with the upper half. So perfect is the operating mechanism that a giant Sweetland Filter, containing 30 tons of crushed ore-sludge, can be opened, discharged, and closed, in five minutes by a boy.

As in the *Kelly Filter*, the cloths are not removed from the leaves, but are washed by admitting hot water to the interior of the leaves.

In a Californian beet-sugar factory, treating from 850 to 900 tons of beet per day, the whole of the *carbonated juice* is filtered twice in three Sweetland Filters, each having 73 square metres (785 sq. ft.) of filtering-surface, and a cake-capacity of 600 kilos. (1320 pounds). After filtration is stopped, and the cakes have been washed, it requires only $4\frac{1}{2}$ minutes to open the filter, discharge the cakes, close the filter, and restart filtration. The three Sweetland Filters (for *carbonated juice*), also other filters for syrup, are operated by only two men per shift, or four men in 24 hours. Truly, a record in economising labour! Most of the cloths remain in constant use for 60 days, or more.

The difficulty in discharging the cakes, due to the latter adhering too firmly to the leaves, was referred to in the case of the *Kelly Filter*, and may also possibly apply to the

Sweetland Filter. It is obvious that the composition and density of the cake, and the subsequent method of using it, must be carefully considered when selecting a filter for a particular industry.

(4) *Syrup Filters*

(a) *Cloth Filters*.—These are usually *leaf-filters*, such as the Philippe Filter (previously described). In this filter, one square metre of filtering-surface is required per 20 hectolitres of syrup, per 24 hours. One Philippe Filter has 20 square metres of filtering-surface.

(b) *Sand-filters*.—These have been already described, under the heading "*juice-filters*."

METHOD (4): CENTRIFUGAL SEPARATION

This is a modification of the *Subsidence Method* (described above). But, instead of relying on the force of gravity to separate the heavier solid matters (or precipitate) from the juice, a much greater force is applied by causing the "*subsider*" itself, and the contained juice, to rotate on a central axis at a sufficiently high speed. The relation between centrifugal force and speed of rotation will be fully discussed in Chapter XXV, and pp. 293 to 295 should be read in conjunction with the following.

One form of *centrifugal-subsider* is shown in section in Fig. 22. It comprises a cylindrical steel drum, with non-perforated walls (AA), mounted on a vertical spindle (BB). This spindle is rotated by suitable driving-gear at its upper extremity (not shown), causing the drum to rotate horizontally. Hence, centrifugal force acts on the contents of the drum at right angles to the face of gravity.

The muddy juice to be treated enters the rotating drum at the point (C), through the rigid feed-pipe (DD), and spreads over the vertical walls of the drum, where it accumulates until it reaches the level (EE), and overflow (F). On turning the diagram round so that the level (EE) becomes horizontal, any section through the drum will represent a horizontal tank, with inlet (C), at one extremity, and overflow (F), at the opposite extremity. The solid matters, being

heavier than the juice, accumulate next to the walls (AA) of the drum (or bottom of tank), leaving a zone of clear juice towards the overflow-level (EE). This zone of clear juice is isolated from the entering muddy juice by the baffle (KK)

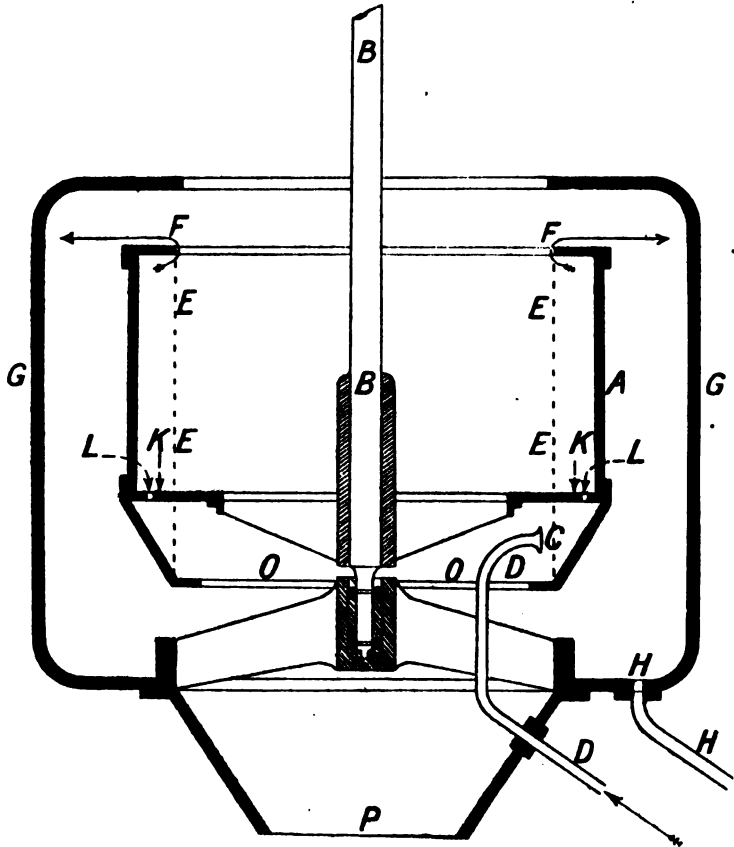

FIG. 22.—CENTRIFUGAL SUBSIDER

with perforations (LL); consequently, the entering muddy juice displaces an equal volume of clear juice, which overflows continuously at (F) into the stationary casing (GG), and escapes by the outlet-pipe (H).

When the deposited solid matters approach to within a certain distance from the level (EE), the entering feed is shut

off, and the machine brought to rest by applying a brake. The deposit is then detached from the walls (AA) of the drum, and falls vertically through the central discharges (OO) of drum, and (P) of the outer casing. The empty machine is once more set in motion, and fed with muddy juice as before.

Subsidence by gravity occupies from 1 to 2 hours, and yields a *fluid sediment* mainly consisting of juice, and therefore requiring further treatment in order to separate this juice, and avoid loss of sugar. Centrifugal-subsidence occupies only 2 or 3 minutes, and yields a semi-solid deposit closely resembling filter-press cake ; and which can be washed with hot water introduced through the feed-pipe (DD), whilst the drum is rotating at full speed. The washings escape at (F) and (H), in the same manner as the clarified juice.

Hence, centrifugal-subsidence may be substituted for the two tedious operations of gravity-subsidence, and filter-pressing of the resulting fluid-sediments. The centrifugal then operates as a *continuous subsider* ; the juice flowing continuously through the machine, and only being shut off at intervals to allow the deposited solids to be discharged.

A less costly method of working consists in clarifying the bulk of the juice by gravity-subsidence (either in separate tanks, or in a *continuous subsider*, such as the Deming, p. 203), leaving only the fluid-sediments to be treated in the centrifugal. The latter then replaces the filter-press, or leaf-filter, and offers the following advantages:—

(1) The absence of cloth, or other filtering media, reduces the working cost.

(2) The rate of centrifugal-subsidence is independent of the porosity of the solids to be separated, being mainly dependent on the speed of the machine, and difference in density between the solids and the juice. Certain gelatinous matters, present in raw cane- and beet-juices, can be separated by centrifugal-subsidence, but not by filtration, owing to the pores of the cloth being blocked by the deposit.

(3) Centrifugal-subsidence can be applied with equal success to acid and alkaline juices ; to cold and hot juices ; to syrup, and even to molasses. It is therefore of wider applicability than the method of filtration.

(4) Centrifugal machines occupy less space and require less handling than filter-presses treating the same quantity of sediment per day.

The first patent for a centrifugal-subsider for sugar juices was that of Possoz in 1859, for removing the *carbonation scums*. Then followed the patents of Weston in 1870; and those of Laidlaw, Hignette, and Heriot, all in 1897; of Kopke in 1913, followed by numerous others. All are based on the principle illustrated above, although the machines differ in detail.

Centrifugal-subsidence as a substitute for filtration has been tested in several factories with some degree of success, but has not yet come into general use. Although theoretically sound, the following difficulty arises when treating juices. The coarse, flocculent precipitate (produced by previous *defecation*, or *sulphitation*) is broken up, or "pulverised" by friction, when the entering feed comes into contact with the rapidly rotating liquid in the drum. In some designs the entering feed is forced through a nozzle, under pressure, thus entering the drum with the same linear velocity as the rotating drum and contents. In this case friction occurs in the nozzle, instead of in the drum, with exactly the same result. The "pulverised" precipitate is very difficult to separate on account of its large surface-area (hence increased friction with the liquid during subsidence), and the treated juice is therefore cloudy.

Two remedies have been proposed: (a) The centrifugal drum may combine the two operations of *subsidence and filtration*, by causing the cloudy *subsided-juice* to pass through a layer of filter cloth before escaping from the rotating drum. Or, (b) The cloudy juice, discharged from the centrifugal, may enter a separate apparatus for filtration, such as the Philippe Cloth-filter, or the Gartley Bagasse-filter. In either method, about 99% of the total solid matters are separated by centrifugal-subsidence, thus dispensing with scum-filters, or filter-presses.

CHAPTER XIX

CHEMICAL TREATMENT OF BEET JUICE

HISTORICAL

THE earliest methods of manufacturing beet sugar were, naturally, suggested by the methods then employed in the cane-sugar factory. Thus, beet juice was first extracted by pressure (after rasping), and hydraulic presses were subsequently replaced by *continuous presses*, closely resembling the cane mill. The juice thus extracted was "clarified" in the same manner as cane juice, by heating it after the addition of a little lime; but this simple treatment failed when applied to diffusion-juice, owing to the relatively small quantities of pectin and albuminoid impurities present in such juice.

From 1825 to 1849, the diffusion-juice was treated with a large excess of lime to precipitate the non-sugars, and then neutralised with sulphuric acid; thus precipitating the lime as insoluble calcium sulphate, which was separated by filtration. In 1840, Kuhlmann suggested carbon dioxide gas as a substitute for sulphuric acid, thus eliminating the danger of inversion of sucrose, and having the additional advantage that calcium carbonate is less soluble than calcium sulphate in solutions of sugar. His suggestion was developed by Rousseau in 1849, but the separation of the calcium carbonate from the juice was unsatisfactory with the type of filter then employed. Ten years later (1859) Périer and Possoz introduced the *Double Carbonation Process*, the success of which was very largely due to the invention of the filter-press, by Danek in 1864.

Hence the *diffusion process*, proposed by Dombasle in 1830, could not be successfully applied until thirty years later. Similarly, Kuhlmann's idea of *carbonation* had to lie dormant for twenty-four years until Danek solved the

mechanical problem of filtration. These examples should serve as a warning to those who claim that "an ounce of practice is worth a ton of theory." What is theoretically sound to-day may be impracticable for want of certain appliances, but becomes "practical" and up-to-date as soon as suitable appliances are invented, or old ones improved.

Powdered bone-charcoal was first used as a bleaching agent for beet juice in 1812. The manufacture of *granulated* bone-char was a great step in advance because this material could be ignited in special furnaces, in order to destroy the organic matters, previously absorbed from the juice, thereby restoring the original bleaching-power of the bone-char, which could be used repeatedly. The char is thus "revivified," from time to time.

Granulated bone-char was formerly used in the manufacture of white sugar from cane- and beet-juices, but the success of the *carbonation process* led manufacturers to abandon bone-char, with the result that it is now only employed in the sugar refinery.

In 1810, sulphur dioxide was suggested as a cheap substitute for bone-char, and was employed in the beet-sugar industry about the year 1849. It has since been extensively used for bleaching cane- and beet-juices.

THE CARBONATION PROCESS

(French = "CARBONATATION")

This process is designed, not merely to precipitate non-sugars from the juice, but also to produce a granular precipitate of calcium carbonate, which permits the entire volume of treated juice to be rapidly filtered (as explained in the last chapter). The carbonate is not added directly to the juice, but is formed within it, by adding first lime, and then carbon dioxide gas:—

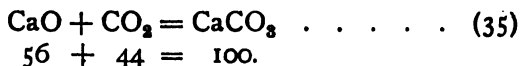

Lime is the purifying agent, precipitating the non-sugars from the juice. Carbon dioxide is the neutralising agent, precipitating the excess of lime; and the resulting calcium

carbonate is the agent which facilitates filtration. The treatment of the limed juice with carbon dioxide gas is termed "*carbonation*."

Heating the Juice.—Beet juice is limed, and carbonated, at a temperature of from 70° to 80° C. Above this temperature, the juice froths excessively, and, at lower temperatures, the carbonated juice filters too slowly. When leaving the diffusion battery, the juice has a temperature of about 30° C., and is passed through one or more tubular juice-heaters (termed "*re-heaters*"), which raise its temperature to about 80° C., before it enters the liming tanks.

Although cold-liming has been generally abandoned, Aulard's modification has recently found favour; the juice, at a temperature of 20° C., being kept in contact with lime for one hour, then gradually heated to 70° C. before the addition of carbon dioxide gas.

Liming the Juice.—The quantity of lime added is determined by the quantity of calcium carbonate required to ensure rapid filtration, and far exceeds the quantity required to precipitate the non-sugars. In the manufacture of raw beet-sugar from 1·5 to 2·0 kilos. of lime are added per 100 litres of juice; and, in the manufacture of white sugar, from 2·0 to 3·0 kilos. of lime per 100 litres of juice.

The lime is added in any of the following forms: (1) lime-cream (as used in the cane-sugar factory); (2) powdered slaked-lime; (3) quicklime in coarse lumps, or in powdered form; and (4) saccharate of lime. Lime-cream is generally used in Belgium and France, but involves careful preparation (see p. 162). Powdered slaked-lime is sometimes added just before *second carbonation* (described below). Quicklime, in coarse lumps, is the general practice in Germany, and is claimed to act more energetically than an equal quantity of lime in the form of lime-cream. It has the further advantage that no water is added to the juice, thus economising steam and fuel when the juice is concentrated to syrup. Saccharate of lime is only adopted in factories which employ the *Saccharate Process* for extracting sugar from the final, or exhausted molasses (see p. 337-341). In this case, the same quantity of lime can be used twice over; first, for extracting

uncrystallisable sugar from molasses, and again, in the form of saccharate, for adding lime to the juice.

In some factories lime-cream is added immediately before the addition of carbon dioxide gas, which then effects the mixing ; but this practice does not allow sufficient time for the free lime to act upon the non-sugars of the juice. It is better to employ a separate liming-vessel fitted with mechanical stirrers, and capable of treating a large volume of juice. The limed juice may remain in this "mixer" for about 15 minutes before passing into the carbonating tanks. Aulard recommends a period of 2 hours, to obtain the best results.

When adding quicklime in coarse lumps, special mixing-vessels are employed, the solid lime being placed in a perforated iron basket immersed in the juice. The basket is kept in constant motion, either rotating on a vertical axis, swinging on a central pivot, or, having an alternating, horizontal motion, until the lime is completely slaked, and mixed with the juice.

Effect of Liming.—Considering the variety of organic and inorganic non-sugars present in beet juice (see p. 139), the chemical effects of lime and heat are complex and difficult to trace. Certain non-sugars form insoluble compounds with lime, being precipitated and subsequently removed by filtration. Others are decomposed, yielding new compounds ; and many form soluble compounds with lime, and remain in solution. Claassen states that only one-fourth to one-third of the total non-sugars are precipitated by lime. Yet no satisfactory substitute has been found, although some 300 purifying agents have been suggested from time to time, and many of these have been submitted to practical tests.

Free acids, and acid salts, are neutralised, with formation of lime-salts. Phosphoric and oxalic acids form insoluble lime-salts, and are precipitated. Those acids which form soluble lime-salts, preferably combine with the stronger bases of potash and soda, only the remainder combining with lime. Ammonia and organic bases (originally combined with the precipitated acids), are set free. Albumin, pectins, and silicates (the latter derived from the added lime), are precipitated. About 20% of the total albumin is precipitated

by the action of lime alone; and about 60% of the total is precipitated after carbonating. Certain nitrogen compounds are decomposed, yielding free ammonia, or organic bases. If rotten beets are being worked, the juice may contain invert sugar, which is rapidly decomposed by lime and heat, forming soluble lime-salts of glucinic and saccharic acids, rendering the juice dark in colour.

The excess of added lime partly combines with sucrose, forming soluble saccharate of lime— $C_{12}H_{22}O_{11}CaO$; but, at a temperature of 80° C. (at which lime is added), a variable quantity of insoluble tri-calcium saccharate— $C_{12}H_{22}O_{11}3CaO$ is formed, leaving from 0.3 to 0.9% of soluble saccharate in solution.

(1) *Single Carbonation*

The simultaneous production of lime and carbon dioxide gas from limestone, the composition of the gas, and method of adding it to the juice, were described in Chapter XVI (pp. 167–171). We have here to consider the chemical changes which occur during *carbonation*.

The limed juice, being strongly alkaline, readily absorbs the gas, but without the immediate formation of granular calcium carbonate. An intermediate, gelatinous precipitate is formed, rendering the juice thick and viscid, and causing it to froth badly, so that a large proportion of the gas escapes through the chimney at the top of the carbonation tank. This loss of gas, and excessive frothing of the juice, have been eliminated in De Haan's modification (see pp. 197–198). The gelatinous precipitate is a compound of sucrose lime, and carbon dioxide, termed hydro-sucro-carbonate of lime, which gradually decomposes, yielding calcium carbonate and a smaller quantity of insoluble tri-calcium saccharate. The juice then becomes fluid, so that the gas is once more readily absorbed, and the frothing ceases. Carbonation is continued until the insoluble tri-calcium saccharate is entirely decomposed, as in the following equation:—

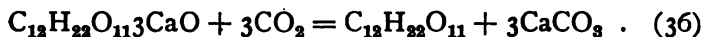

Any undecomposed saccharate would remain in the filter-

press cake causing a loss of sucrose, the chemically combined sucrose not being removed by washing the cakes with hot water.

Care must be taken not to continue the carbonation beyond this point, because an excess of gas combines with calcium carbonate, forming the soluble bicarbonate, as follows:—

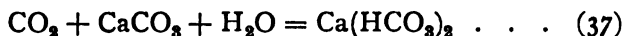

The bicarbonate decomposes when the filtered juice is boiled in the evaporator, yielding carbon dioxide gas, and depositing insoluble calcium carbonate, as a "scale," on the heating-surface of the evaporator.

After the supply of gas is stopped, steam is admitted to a coil in the bottom of the carbonation tank in order to heat the juice to about 95° C. It is then pumped through filter presses (p. 213) to separate the precipitate (calcium carbonate + non-sugars from the juice) in the form of cakes which are washed with hot water in the filter-presses to remove the residual juice, and then discharged into a suitable receiver. It is claimed that the calcium carbonate absorbs certain colouring matters from the juice, which were not precipitated by the previous action of lime before carbonation.

Control Tests.—The completion of the *carbonation* may be judged by the appearance of a sample of the juice in a test-tube (see *Settling Test* on p. 182). The precipitate should subside gradually, leaving the juice transparent and light in colour. If subsidence be very slow, the juice has not been sufficiently carbonated, but, if rapid, and the clear juice dark in colour, the juice has been over-carbonated.

The modern method of control consists in measuring the alkalinity of the treated juice by titration with standard acid (1 c.c. neutralising 1 milligram of CaO), with phenolphthalein as indicator. Thus, if 10 c.c. of juice are neutralised by 15.0 c.c. of standard acid, the alkalinity of the sample was $0.015 \times 10 = 0.15 \text{CaO}$ per 100 c.c. of juice. This titration may be effected in the *Vivien Tube*, previously described on p. 195, by the workman in charge of the carbonation tanks. The degree of alkalinity which ensures rapid filtration and a light-coloured juice, is determined by the factory chemist daily,

and the workman conducts the carbonation to the desired point.

(2) *Double-Carbonation*

Theory.—In the process described above, certain of the precipitated non-sugars and colouring matters re-dissolve during carbonation, as soon as the alkalinity of the juice falls below a certain limit. If carbonation be stopped before this limit is reached, the filtered juice remains excessively alkaline, and the subsequent crystallisation during boiling in the vacuum pan is rendered difficult.

Both objections are avoided by conducting the carbonation in two stages, hence the name "*double-carbonation*." The first stage precipitates the bulk of the lime, leaving the juice sufficiently alkaline (0·07 to 0·10% CaO), to prevent any of the precipitated non-sugars from re-dissolving, and this precipitate is at once removed by filtration. The clear, filtered juice is again carbonated, in order to neutralise the remaining alkalinity, causing a second precipitation of calcium carbonate which is removed by a second filtration, yielding transparent neutral juice of a light colour.

The various stages of double-carbonation may now be considered in detail.

(a) *Liming.*—This operation has already been described under "*single carbonation*."

(b) *First Carbonation.*—Two carbonation tanks are always in action, whilst a third is filling with juice, and a fourth emptying; each tank, in turn, being filled with the limed juice, carbonated, and discharged. If the cold juice be heated in the carbonation tank before carbonation begins, a fifth tank will be required for this operation. For every 1000 hectolitres of juice treated per 24 hours, the carbonation tanks must provide a working capacity of 63 hectolitres; and, as two tanks are in action at one time, each must have a working capacity of 32 hectolitres per 1000 hectolitres of juice.

As the juice froths considerably during carbonation, the actual capacity of each tank must include an empty space of 3 metres (about 10 feet) above the level of the juice. In Austria very large carbonating tanks are used, 8 metres

(26 feet) in height; the working capacity (juice-level) being only one-third of the total height, or 2·7 metres from the bottom. The excessive frothing of the juice, requiring free space in the carbonation tanks, is avoided in De Haan's modification (see pp. 197-198). The carbonation is stopped as soon as the alkalinity of the juice falls to about 0·07 to 0·10% CaO.

(c) *First Filtration.*—In modern German factories 1 square metre of filtering-surface is allowed for 2500 kilos. of beets per 24 hours, and the filter-press cakes vary in thickness from 15 to 30 mm. (0·6" to 1·2"). The cakes are washed with water until they contain only from 1·0 to 2·0% of sucrose (average 1·5%). If the previous carbonation has been satisfactory, the cakes have a pale, yellowish-grey colour, and are firm and brittle. A cross-section through a cake reveals successive layers of different tints, due to slight differences in the alkalinity of the juice treated in the different carbonation-tanks. The cakes are firmer and lighter in colour, in proportion to the quantity of lime added; but are soft, dark-coloured, and difficult to wash if too little lime has been used. The dry solid matter of the cake contains about 75% of calcium carbonate, about 10% of organic non-sugars (precipitated from the juice by the action of the lime), and from 1·0 to 2·0% of sucrose, due to juice which has not been completely removed during the washing operation.

When the rate of filtration is slow, it is customary to increase the amount of lime added to the juice (consequently, also, the amount of carbon dioxide gas), thus increasing the calcium carbonate in the dry solid matter of the cake, and rendering the latter more porous. But slow filtration is sometimes experienced when the beets are of inferior quality, also, when the diffusion is conducted at too high a temperature. Further, as the filter-cloths become hard and non-porous after frequent use, new cloths are required about once a week. After a filter-press is discharged, the cloths are cleaned, either in special washing-machines designed for the purpose, or by scrubbing with suitable brushes; and, occasionally, by dipping the cloths in dilute hydrochloric acid, which dissolves out the less soluble lime-salts.

(d) *Second Liming.*—The clear, filtered juice resulting

from the *first carbonation* is pumped through a juice-heater (raising its temperature to boiling point) and enters a second set of carbonation tanks, similar to those employed for the *first carbonation*. About 0.25% of lime (in the form of lime-cream) is usually added, but this second liming is frequently omitted.

(e) *Second Carbonation*.—As this operation occupies about half the time required for the *first carbonation*, fewer carbonation tanks are required; and, as there is only moderate frothing of the juice, less free space is necessary, and each tank can be filled with juice to rather more than half its actual capacity.

Carbonation is continued until the alkalinity of the juice falls within the limits of 0.03 to 0.06% CaO, the exact point depending on the quality of the beets treated. This final alkalinity, although expressed as lime, is due to carbonates of potash, soda, and ammonia, which cannot be neutralised by carbonation. Care must be taken to avoid any excess of carbon dioxide, as explained under *single-carbonation*. The juice is now said to be "*saturated*"; the second carbonation being termed the "*saturation*," and the first treatment with gas the "*carbonation*." The "*saturated juice*" is finally boiled to decompose any bicarbonate which may be present, and then passes to the filter-presses. ✓

(f) *Second Filtration*.—As the quantity of calcium carbonate to be separated is only about one-third of that resulting from the *first carbonation*, the filtering-surface at this stage may be only one-third of that required for the *first filtration*. A simpler type of filter-press is generally used, not provided with water-channels for washing the cakes, and permitting any filtering-chamber to be isolated from the others, in case this yields cloudy juice. A cloudy filtered juice is not of great consequence in the *first filtration*, since this juice has to be re-carbonated and re-filtered, but the *second filtration* should yield a perfectly transparent liquid, which passes to the evaporator and is concentrated to syrup. The residual juice adhering to the cakes, is displaced by blowing steam through the press. The discharged cakes contain from 4.0 to 7.0% of sucrose, and are much

whiter than the cakes obtained in the *first filtration*, because they contain very little non-sugar and colouring matters derived from the juice.

Under normal conditions, this *second filtration* presents no difficulty, but is sometimes retarded by the following defects:—

(a) When the second carbonation is carried too far part of the precipitated calcium carbonate re-dissolves, as soluble bicarbonate (equation (37)), and may be incompletely decomposed by boiling before filtration. Decomposition then continues during filtration, insoluble calcium carbonate being deposited in the pores of the filter-press cake, which thus become impervious to the juice.

(b) Magnesia is a common impurity of limestone, and is therefore a constituent of the quicklime added to the juice. During the *first carbonation*, such magnesia is partially converted into insoluble magnesium carbonate, the remainder being present as hydroxide. As the latter is insoluble in alkaline juice, it should be removed by the first filtration. But if the *first carbonation* be carried too far, this magnesium hydroxide passes into solution, and is re-precipitated during the *second carbonation*, but in a gelatinous form as hydrocarbonate of magnesia, rendering the filter-press cake less porous.

When the *double-carbonation process* is conducted with care, the loss of sucrose in the filter-press cakes is small. The following figures are given by Claassen:—

	Weight of Cake % of Beet.	Sucrose % in Cake.	Sucrose lost % on Beet.
First Carbonation .	8.0%	1.5%	0.12
Second Carbonation .	0.5%	4.0%	0.02
			Total loss = 0.14

The loss necessarily increases with the weight of cake formed, and is frequently double the above. It may be still further increased by defective carbonation, and presence of undecomposed tri-calcium saccharate.

Control Tests.—These are similar to the tests applied in *single carbonation* (p. 232).

(3) *Triple-carbonation*

The principle of double-carbonation has been further elaborated by Karlik. The *first carbonation* is stopped when the alkalinity of the juice is reduced to 0·08% lime, the juice being then filtered. To the filtered juice, from 0·4 to 1·0% of lime is added before the *second carbonation*, which is stopped when the alkalinity falls to from 0·05 to 0·06% lime, the juice being then filtered a second time. The clear juice is then carbonated a third time, until the alkalinity falls to 0·02 to 0·03% lime. Although *triple-carbonation* has been extensively employed, the advantages claimed for it do not compensate for the increased cost of plant and labour.

SULPHITATION

The purifying and bleaching properties of sulphur dioxide have been the subject of much controversy in the beet-sugar industry, and differences of opinion still exist as to the most effective method of using this agent.

It is generally admitted that sulphur dioxide precipitates only those non-sugars which are precipitated in the *carbonation process*; consequently, that it can exert little, if any, purifying action when applied after *carbonation*. When applied to the raw diffusion-juice, an abundant precipitate of non-sugars is obtained, but the gelatinous nature of this precipitate renders it exceedingly difficult to separate by filtration. Hence, sulphitation has been generally applied after the *first carbonation*, either to the dilute juice, to partially concentrated juice, or to the syrup leaving the evaporator. The following advantages are claimed :—

(a) The bleaching action renders the carbonated juice and resulting syrup lighter in colour.

(b) The syrup crystallises more readily in the vacuum pan and crystallisers, and the cured sugar has superior keeping qualities.

(c) Organic lime-salts are decomposed by sulphur dioxide

(not by carbon dioxide), the lime being precipitated as insoluble calcium sulphite, and the organic acids set free.

The following diagram indicates the various stages at which sulphitation may be employed :—

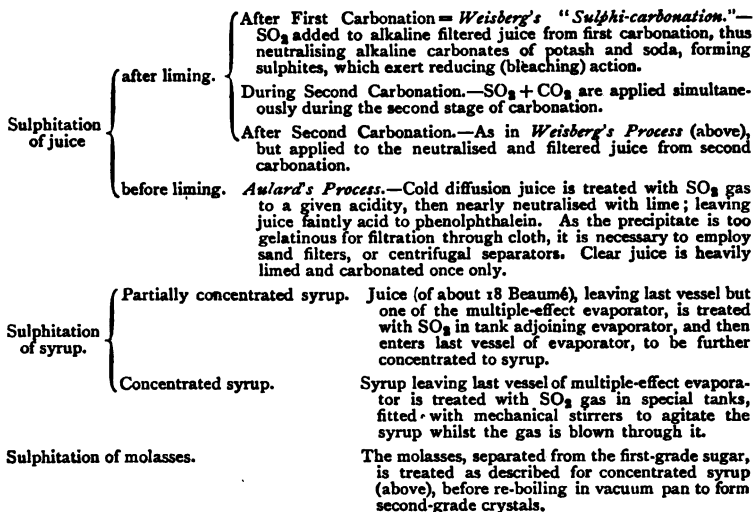

The advantage of *juice-sulphitation* lies in the fact that the alkaline carbonates of potash and soda are converted into neutral sulphites, which exert a reducing (and bleaching) action during the subsequent concentration of the juice to syrup. This reducing action has three important results, namely :—

(a) It prevents any darkening in colour during concentration to syrup. This is proved by diluting the syrup with distilled water to the density of the carbonated juice (entering the evaporator), and comparing the colours of the two liquids in test-tubes of equal diameter. When no sulphur dioxide is used, the colour of the diluted syrup may be twice, or three times as intense as that of the juice before evaporation.

(b) Amide compounds, which interfere with the subsequent crystallisation of the sucrose, are decomposed during concentration of the carbonated and sulphited juice in the evaporator.

(c) Ferric compounds are reduced to the ferrous state, the

latter being more completely precipitated during the *second carbonation*, so that iron salts are removed in the precipitate. This is of considerable importance in the manufacture of white sugar (see pp. 131-133).

Aulard's Process of Sulphitation before Liming has the advantage of requiring only from 0.8 to 1.0% lime on weight of beets treated; and also eliminates the *second carbonation* and *second filtration*. He claims that the bleaching effect of sulphur dioxide is 50% greater when applied before liming than when after liming, and explains this by the theory that free alkali "fixes," or even intensifies the colour of the juice, so that the after-effect of sulphur dioxide is diminished. Sulphitation, followed by neutralisation with barium hydroxide (instead of lime), produces a greater bleaching effect, and juice of higher purity, than when the same raw juice is treated by the usual double-carbonation process.

The methods of sulphitation of juice and syrup have already been dealt with in Chapter XVII, to which the student should refer.

Control Tests.—As the effect of sulphitation is to render the juice or syrup faintly acid to phenolphthalein, the operation is controlled by means of the tests described under "*Acid-sulphitation Process*" for cane-juice (p. 195).



PART VI

EVAPORATION OF WATER FROM THE JUICE

CHAPTER 20. DEFINITIONS—PRINCIPLES OF MULTIPLE-EFFECT
EVAPORATION

CHAPTER 21. TYPES OF EVAPORATORS USED, AND MODE OF
OPERATING—EFFICIENCY



CHAPTER XX

PRINCIPLES OF MULTIPLE-EFFECT EVAPORATION

DEFINITIONS

(1) *Evaporation*.—In many industries, liquids are concentrated by “surface-evaporation,” at temperatures below their boiling points. In the sugar industry, evaporation is effected at boiling point.

(2) *The Boiling Point* is that temperature at which vapour is evolved *within* the mass of liquid, due to the (internal) vapour pressure being equal to the external atmospheric pressure acting upon the surface of the liquid. The boiling points of liquids under atmospheric pressure are termed *normal boiling points*. By artificially increasing the external pressure, the boiling point of a liquid is raised; and by reducing this pressure below that of the atmosphere, the boiling point is lowered. The latter method, or *boiling in vacuo*, is adopted when treating liquids containing organic substances in solution, since decomposition may occur at the *normal boiling points*.

A solution of a solid in water has a higher boiling point than pure water, the increase being directly proportional to the concentration (at a given pressure), but constant at different pressures (for a given concentration), as shown below:—

At a pressure of 14·7 lbs. (atmospheric), water boils at 212° F.	} difference =	18·6° F.
and an 80% sugar solution at 230·6° F.		
At a pressure of 2·0 lbs. (partial vacuum), water boils at 126° F.	} difference =	18·6° F.
and an 80% sugar solution at 144·6° F.		

(3) *Vacua*.—An apparatus for *boiling in vacuo* is fitted with a gauge to measure the degree of vacuum within the vessel. Three systems of graduating this gauge are shown in the following Table; also the relations between the three

systems. The first horizontal line represents the mean atmospheric pressure, measured in millimetres, and in inches of mercury (in the barometer). The last horizontal line represents a *perfect vacuum*, or absence of pressure. The intermediate lines therefore represent partial atmospheric pressures, or various *degrees of vacuum*. Thus, 27" vacuum indicates a partial pressure of $30'' - 27'' = 3''$ of mercury, or one-tenth of one atmosphere, or 76 mm. mercury.

TABLE VII.—DEGREES OF VACUA

Unit and Tenths of one Atmosphere.		Millimetres of Mercury.		Inches of Mercury.	
Pressures.	Vacua.	Pressures.	Vacua.	Pressures.	Vacua.
1·0	nil	760	nil	30	nil
0·9	0·1	684	76	27	3
0·8	0·2	608	152	24	6
0·7	0·3	532	228	21	9
0·6	0·4	456	304	18	12
0·5	0·5	380	380	15	15
0·4	0·6	304	456	12	18
0·3	0·7	228	532	9	21
0·2	0·8	152	608	6	24
0·1	0·9	76	684	3	27
nil	complete	nil	complete	nil	complete

(4) *Heat Units*.—The *British Thermal Unit* (B.T.U.), is the quantity of heat required to raise the temperature of one pound of water 1° F. As this quantity varies slightly with the initial temperature, the rise is assumed to be from 60° to 61° F. The *Metric Thermal Unit* (Calorie), is the quantity of heat required to raise the temperature of one kilogram of water 1° C. The rise in temperature is assumed to be from 0° to 1° C., but is more generally taken from 15° to 16° C. The relation between the Calorie and the B.T.U. is as follows:—

Calorie = heat required to raise the temperature of 1 kilogram of water 1° C.
 or 2·2 pounds ,, ,, $1·8^{\circ}$ F.
 or 3·968 B.T.U.

(5) *Specific Heat* is the number of heat-units required to raise the temperature of a unit weight of any substance through one degree. The unit of weight, and unit of tempera-

ture, are both involved in the "heat-unit," defined above. As this heat-unit is expressed in terms of water, it follows that the specific heat of water is adopted as unity.

(6) *Total Heat of Steam at t_B :—*

British Units = $1082 + \cdot 305 t_B$

Thus, if $t_B = 212^\circ \text{ F.}$, total heat = 1146.66 B.T.U. per pound weight.

Metric Units = $606.5 + \cdot 305 t_B$

Thus, if $t_B = 100^\circ \text{ C.}$, total heat = 637 calories per kilogram weight.

(7) *Latent Heat of Steam at t_B , condensing to Water at t_W .—*

British Units = $(1082 + \cdot 305 t_B) - (t_W - 32)$

Thus, if t_B and $t_W = 212^\circ \text{ F.}$, latent heat = 966.6 B.T.U. per pound weight.

Metric Units = $(606.5 + \cdot 305 t_B) - t_W$

Thus, if t_B and $t_W = 100^\circ \text{ C.}$, latent heat = 537 calories per kilogram weight.

(8) *Self-evaporation.*—When a liquid, boiling under pressure P_A , at temperature t_A , passes into a second vessel, at a lower pressure P_B , the boiling point falls to t_B , and the excess of heat ($t_A - t_B$) is set free, causing a supplementary, or "self-evaporation," which is measured as follows :—

British Units $\frac{100(t_A - t_B)}{1114 - \cdot 695 t_B} = \left\{ \begin{array}{l} \text{pounds of water evaporated by self-evaporation,} \\ \text{per 100 pounds of boiling liquid.} \end{array} \right.$

Metric Units $\frac{100(t_A - t_B)}{606.5 - \cdot 695 t_B} = \left\{ \begin{array}{l} \text{kilos. of water evaporated by self-evaporation,} \\ \text{per 100 kilos. of boiling liquid.} \end{array} \right.$

Self-evaporation will be referred to under "*Heat entering Evaporator,*" in Chapter XXI, p. 260.

(9) *Transmission of Heat.*—The heating-agent (usually steam), and the liquid to be evaporated, are separated by a metal partition called the *heating-surface*, which may have the following forms :—

- (1) Straight tubes, or coils, enclosing the steam, and surrounded by the liquid.
- (2) Tubes through which the liquid circulates, with steam surrounding the tubes (reverse of (1)).
- (3) Steam-jacket, or double-bottom, enclosing the steam, the liquid being contained in the inner vessel.

In each case, the area of heated metal in contact with the liquid is termed the *heating-surface*, and the transmission of heat through the metal is directly proportional to the difference in temperature, or *temperature-fall*, between the steam side and the liquid side. One surface of the metal acts as a

cooling- (or *condensing-*) *surface* for the steam, and the opposite surface of the metal acts as a heating-surface for the liquid.

Let t_s = temperature of steam ; t_L = temperature of boiling liquid ; and t_w = temperature of condensed steam. The *temperature-fall* will be $t_s - t_L$, and t_w will lie between these two temperatures. When the *temperature-fall* is high, much steam is condensed per unit of time, and t_w approaches t_s . When the *temperature-fall* is small, less steam is condensed per unit of time, and t_w approaches t_L . The quantity of heat transmitted = (total heat of steam at t_s) - (sensible heat of condensed steam at t_w), as given by previous definitions.

The *evaporating-power* of the *heating-surface* increases with the *temperature-fall*, namely, on raising t_s , or on lowering t_L . As cane- and beet-juices darken in colour at high temperatures, an increase in t_s is undesirable, and the rational course is to lower t_L by *boiling in vacuo*.

The transmission of heat involves three steps, namely :—
(a) from steam to metal ; (b) through the metal (from the steam side to the liquid side) ; and (c) from the metal to the liquid.

Step (a). The condensing steam forms a film of water on the metal surface, thereby introducing a poor conductor of heat. The apparatus must, therefore, be designed to allow this water to drain away rapidly. When employing exhaust-steam as heating-agent, traces of lubricating oil may also be deposited on the metal heating-surface.

The accumulation of air, or other incondensable gases in the steam-space can generally be avoided by special outlet-cocks.

Step (b) presents no difficulty, since all metals are efficient heat-conductors. The heating-surface is usually brass, or copper, but steel may also be employed.

Step (c), or transmission of heat from the metal to the liquid, may be retarded by the following :—

- (1) The viscosity of the liquid, for which there is no practical remedy.
- (2) Imperfect circulation of the liquid over the heating-surface, due, either to defective design of the evaporator, or to excessive viscosity of the liquid

treated. In the latter case, mechanical stirrers are sometimes employed.

- (3) The formation of "scale" on the heating-surface, due to the deposition of mineral matters which are soluble in the original (dilute) liquid, but less soluble in the concentrated liquid. Frequent cleaning of the heating-surface is the only remedy.

Coefficient of Heat-transmission.—The combined result of the foregoing defects is expressed as follows:—

British Units.—The number of B.T.U. transmitted per square foot of metal surface per minute, when the difference in temperature on opposite sides is 1° F.

Metric Units.—The number of calories transmitted per square metre of metal surface per minute, when the difference in temperature on opposite sides is 1° C.

The relation between the two coefficients is as follows:—

$$\begin{aligned} \text{Metric Coefficient} &= \text{calories per sq. m. per } 1^{\circ} \text{ C.} \\ &= 3.968 \text{ B.T.U. per } 10.77 \text{ sq. ft. per } 1.8^{\circ} \text{ F.} \\ &= 0.2047 \text{ " " " " " " } 1^{\circ} \text{ F.} \\ &= 4.88 \text{ British coefficient.} \end{aligned}$$

EVAPORATION BY MULTIPLE EFFECT

Fig. 23 represents the simplest case of multiple-effect evaporation; two similar vessels, I and II, being connected by a pipe leading the vapour, evolved in I, to the heating-surface in II; vessel I being heated by steam at temperature t_g . Two methods of operating this double-effect will be considered.

Method 1. Under Atmospheric Pressure.—The vapour evolved in II passes into the atmosphere through the open vapour-pipe at top, and the liquid contained in II therefore boils under atmospheric pressure, at temperature t_2 . To maintain this temperature, there must be a sufficient *temperature-fall* ($t_1 - t_2$) in vessel II; consequently, the vapour passing from I into II must have the higher temperature t_1 .

Similarly, to maintain this higher temperature t_1 , in vessel I, there must be a sufficient *temperature-fall* ($t_g - t_1$) in vessel I;

consequently, the steam employed for heating I must have the higher temperature t_8 .

The *total temperature-fall* in the double effect is therefore $t_8 - t_2$. The lower temperature (t_2) is fixed by:—(a) the atmospheric pressure acting upon the surface of the liquid, and (b) the *normal boiling-point* of this liquid. The higher temperature (t_8) can be varied by employing steam at different

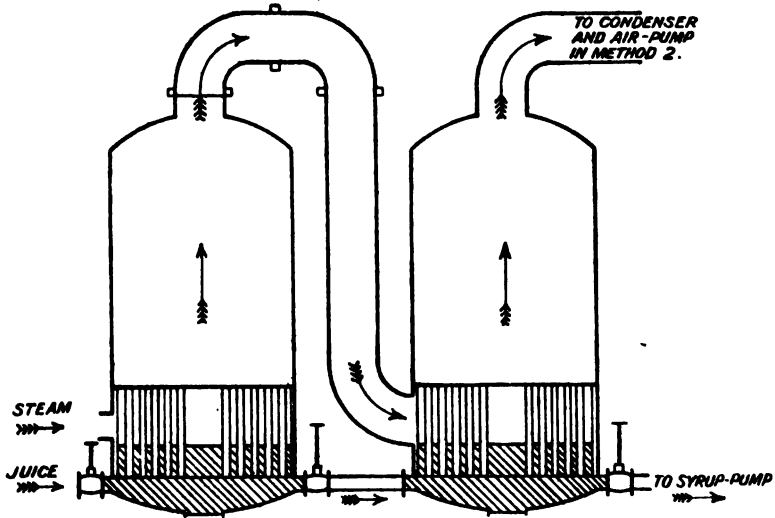

FIG. 23.—DOUBLE-EFFECT EVAPORATOR
(Vertical Section)

boiler-pressures. The boiling point (t_1), in vessel I, adjusts itself automatically between t_8 and t_2 .

Method 2. Under a Vacuum.—The vapour-pipe on vessel II is connected to a condenser and air-pump, thus producing a vacuum in II, and lowering the boiling point of the contained liquid from t_2 (in method I) to t_3 . It will be evident that the other temperatures, t_1 and t_8 (in method I) can also be reduced in the same ratio, without affecting the *temperature-falls* in each vessel, or the *total temperature-fall* in the combination of vessels.

The boiling point t_3 in vessel II is fixed by the reduced pressure in this vessel, but can be varied (within narrow limits)

by varying the *degree* of vacuum. The temperature of the steam entering vessel I can be varied considerably (as in method 1), causing the boiling point in vessel I to adjust itself between the two extremes, as before.

The difference between methods 1 and 2 lies in the fact that nearly equal temperature-falls are obtained at different initial temperatures; method 1 representing what may be termed "*high temperature evaporation*," whereas "*low temperature evaporation*" is the feature of method 2. A further difference may be noticed; namely, that steam (or other form of power) is required to drive the air-pump in method 2, in addition to the steam used as heating-agent in vessel I.

The addition of a third vessel converts the *double-effect* into a *triple-effect* (Fig. 24), and additional vessels produce the quadruple- and quintuple-effects. One pound of steam evaporates approximately 1 pound of water in a single-effect; 2 pounds in a double-effect; 3 pounds in a triple-effect, and so on. We therefore use the term "*steam economy*" to express the number of pounds of water evaporated per pound of boiler-steam used as heating-agent.

Multiple-effect evaporation *in vacuo* was invented by a French engineer—Degrand—in 1836, and perfected by another Frenchman—Rillieux—in 1845, about thirty years after Howard invented the Vacuum Pan (or single-effect evaporator). Being resident in America, Rillieux first applied his apparatus in the cane-sugar industry in Louisiana, where several evaporators were in operation in 1851, and in Cuba, Mexico, and Peru. The system was adopted in one factory in India, before 1870; in Egypt, in 1872; in Java, in 1873; and in Demerara, in 1880. It was first applied in the beet-sugar industry in France, in 1850–1852, before being generally adopted in the cane-sugar industry.

Rillieux also applied the multiple-effect principle for raising the temperature of the juice during certain factory operations, and this "*multiple-effect heating*" will be referred to below. He was also the first to employ exhaust-steam as heating-agent, such steam having hitherto been discharged into the atmosphere, and lost.

Heat-transmission in the Multiple-effect Evaporator

Referring to Fig. 23, the latent-heat of steam, at temperature t_s , is transferred to the vapour generated in I, the steam being completely condensed. Similarly, the latent-heat of the vapour generated in I is, in turn, transferred to the vapour generated by the juice boiling in II; the process being repeated in as many vessels as desired. The vapour generated in the last vessel passes, either into the atmosphere (method 1 above), or to a separate condensing apparatus (Rillieux' system, method 2).

The result may therefore be stated as follows :—For every pound of exhaust-steam used as heating-agent in vessel I, approximately one pound of vapour escapes from the last vessel in the series. At the same time about one pound of water is *distilled* from every vessel (except the last), these distillations causing transmission of heat from vessel to vessel. Thus, in a quadruple-effect, one pound of uncondensed vapour escapes from vessel IV, and additional pounds of water are distilled in vessels I, II, and III, making a total of 4 pounds of water separated from the four vessels, per pound of exhaust-steam entering vessel I. This great economy of steam necessitates a loss of evaporating-power *per unit of heating-surface*, as follows.

Single Effect versus Triple Effect.—Let the single-effect be a duplicate of any one vessel forming the triple-effect, and contain 500 sq. ft. of heating surface; the triple-effect therefore containing 1500 sq. ft. of heating-surface. Assume, further, that vessel I of the triple-effect is heated by the same steam as is used in the single-effect; that the same vacuum exists in the third vessel of the triple-effect as in the single-effect; and that the same liquid is evaporated in both.

The temperature-fall will be the same in the two cases, but in the single-effect it occurs in one vessel only, whereas, in the triple-effect it is divided between three separate vessels. The single-effect can evaporate about 18 pounds of water per square foot of heating surface, per hour; and, as the apparatus contains 500 sq. ft. of heating-surface, this amounts to 9000 pounds of water per hour.

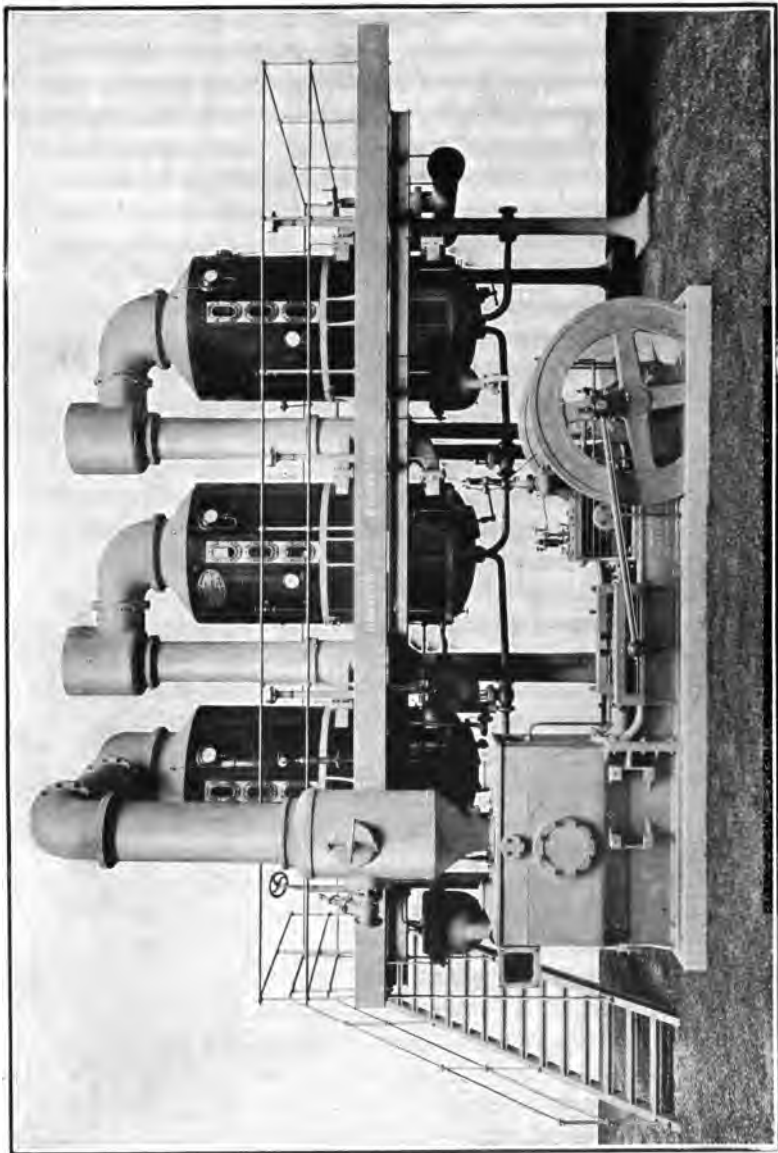

FIG. 24. TRIPLE-EFFECT EVAPORATOR, WITH CONDENSER AND PUMP.
(The Harvey Engineering Co., Ltd. Glasgow.)



As a single vessel of the triple-effect has only one-third of the temperature-fall in the single-effect, the evaporation per square foot of heating-surface, per hour, would be $\frac{1}{3}^3 = 6$ pounds of water; and the three vessels, together, would evaporate $6 \times 1500 = 9000$ pounds of water per hour; the same result as in the single-effect. But the latter consumes three times as much steam in order to evaporate the same total quantity of water.

Evaporating Power, or "*Capacity*," is defined thus:—pounds of water evaporated per hour, per square foot of heating-surface. This affords a common basis for comparing the work performed by evaporators of various dimensions. The value obtained, multiplied by the total heating-surface (in all the vessels), gives the "*Output*," or *actual evaporation* per hour.

Coefficient of Heat-transmission, or *efficiency of heating-surface* is found by dividing the *Evaporating Power* by the average temperature-fall in a single vessel.

We then find the following general relations between a single-effect and any multiple-effect, when operating under similar conditions.

TABLE VIII.—COMPARISON OF SINGLE- AND MULTIPLE-EFFECT EVAPORATORS

	Single Effect.	Multiple Effect.
Number of vessels	I	N
Total heating-surface (sq. ft.)	S	NS
Pounds water evaporated per hour, per vessel	W	$\frac{W}{N}$
Pounds water evaporated per hour, by N vessels	—	$\frac{W}{N} \times N = W$
Temperature-fall per vessel	T	$\frac{T}{N}$
Steam Economy = lbs. water evaporated per lb. steam	I	N
Evaporating Power = lbs. water evaporated per sq. ft. heating-surface per hour	$\frac{W}{S}$	$\frac{W}{N} \div S = \frac{W}{SN}$
Coefficient of heat-transmission = lbs. water evaporated per sq. ft. heating-surface per hour per degree of temperature-fall	$\frac{W}{S} \div T = \frac{W}{ST}$	$\frac{W}{SN} \div \frac{T}{N} = \frac{W}{ST}$

The number of vessels which can be combined in a multiple-effect evaporator is limited by the temperature-fall

in the individual vessels. If this be too small, it may be insufficient to overcome the factors which retard heat-transmission, referred to on pp. 246-247.

If x = number of vessels, and y = average temperature-fall per vessel, the total temperature-fall (xy) can only be increased in the two directions, previously stated. As very little advantage is gained by increasing the vacuum in the last vessel above 26", the only alternative is to increase the temperature of the steam entering the first vessel; consequently, increasing the boiling point in this first vessel. Whether this higher temperature can be used depends entirely on the nature of the liquid to be evaporated.

In most cane-sugar factories, the multiple-effect evaporator is heated by exhaust-steam from the mill engine (which would otherwise be wasted), and the pressure and temperature of this steam necessarily limits the temperature-fall available for evaporating the juice; so that quadruple-effects represent the limit in this particular case. Multiple-effect evaporators with ten vessels have been recently used for certain liquids.

Evaporation Formulae

The quantities of water evaporated, and of syrup produced, can be calculated from the relative densities (Brix degrees) of juice and syrup, by the following formulæ:—

	<i>Examples.</i>
Let B_j = Brix of juice	17·2
D_j = Specific gravity of juice	1·071
B_s = Brix of syrup	53·3
D_s = Specific gravity of syrup	1·251

Per cent. by Weight on Juice:—

$$\begin{aligned} \text{Water evaporated} &= \frac{100(B_s - B_j)}{B_s} = \frac{100(53\cdot3 - 17\cdot2)}{53\cdot3} = 67\cdot73\% \\ \text{Syrup obtained} &= 100 - 67\cdot73 = 32\cdot27\% \end{aligned}$$

Per cent. by Volume on Juice:—

$$\begin{aligned} \text{Water evaporated} &= \frac{100D_j(B_s - B_j)}{B_s} = \frac{107\cdot1(53\cdot3 - 17\cdot2)}{53\cdot3} = 72\cdot54\% \\ \text{Syrup obtained} &= 100 - 72\cdot54 = 27\cdot46\% \end{aligned}$$

HEATING BY MULTIPLE EFFECT

The steam evolved from boiling juice (which may be termed "juice-steam") can be substituted for *boiler-steam*, not only for

evaporating water, but also for heating cold juice to various temperatures, resulting in further economy of fuel. The following general methods of *multiple-effect heating* are employed.

Low Temperature Heating.—If the first vessel of the multiple-effect evaporator be made larger than the following vessels, it generates more *juice-steam* than is required for heating the second vessel. The surplus is drawn off and employed for heating the cold juice *by double-effect*. Similarly, if *juice-steam* be drawn from the *second vessel* of the evaporator, it can be employed elsewhere for heating juice *by triple-effect*; and so on. In the latter case, the heat units in the original, or *boiler-steam*, are utilised twice for evaporation, and again for heating the juice during diffusion, or during carbonation, where relatively low temperatures are required. The temperature of the *juice-steam* obviously depends on which vessel of the multiple-effect it is drawn from. The method is only applicable when juice has to be heated to moderate temperatures.

High Temperature Heating.—The *Pre-evaporator* is an apparatus for boiling juice under pressure, in order to produce *juice-steam* of high temperature; the heating-agent being *boiler-steam* at about 30 pounds pressure. Decomposition of sugar is avoided by pumping the juice through the *Pre-evaporator* at such a velocity that it is only raised to a high temperature for a minute or two. The apparatus produces:—(a) high-temperature *juice-steam*, and (b), partially concentrated juice, which at once enters the first vessel of the evaporator. The *juice-steam* can be used as heating-agent in the juice-heaters, vacuum pans, or in the first vessel of the multiple-effect evaporator. Thus, if the *Pre-evaporator* supplies *juice-steam* to a triple-effect, the combination represents a quadruple-effect (the *Pre-evaporator* acting as first vessel), and more juice can then be concentrated to syrup per hour than by the original triple-effect. But, it should be observed that this increased evaporation is due to the fact that the *temperature-fall* in the *Pre-evaporator* is added to the *temperature-fall* in the triple-effect, producing a larger *total temperature-fall*.

CHAPTER XXI

TYPES OF EVAPORATORS USED—MODE OF OPERATING AND EFFICIENCY

THE foregoing operations of extracting and purifying the juice differ considerably in the cane- and beet-sugar factories, but the remaining operations are identical.

The juice has now to be concentrated to a supersaturated syrup from which the contained sugar can crystallise, the non-sugars remaining dissolved in the mother-liquor, and this fluid being separated from the crystals in centrifugal machines.

The evaporation of water is carried out in several stages, as follows :—

(a) About 70% by weight is evaporated by multiple-effect, the resulting syrup having a density of about 30° Beaumé (55° Brix), and therefore containing about 45% of water. The syrup is an unsaturated solution, free from crystals.

(b) The syrup is re-boiled in a vacuum pan (single-effect) until, by further evaporation of water, crystals are formed, and caused to grow. The resulting product (*massecuite*) is subjected to centrifugal force, which separates the crystals from the mother-liquor (*first molasses*).

(c) The mother-liquor obtained in (b) is re-boiled in the vacuum pan, and produces a *second massecuite*, which, on centrifugal treatment, yields second-sugar and a second mother-liquor (*second molasses*).

(d) The mother-liquor obtained in (c) must generally be re-boiled in order to crystallise the last portions of sugar, leaving a very impure mother-liquor (*final or exhausted molasses*).

Stages (b), (c), and (d) may be partially combined, as will be explained later.

(a) CONCENTRATION OF JUICE TO SYRUP

This is performed by multiple-effect, with a vacuum of about 26" in the last vessel, and exhaust-steam as heating-agent in the first vessel.

Types of Multiple-effect Evaporators

These may be grouped under two heads, namely:—Bulk Evaporators, and Film Evaporators.

The *Bulk Evaporator* is shown in Fig. 23 (double-effect), and in Fig. 24 (triple-effect). The name is derived from the fact that the heating-surface is submerged in a considerable bulk of liquid, which circulates through numerous vertical tubes, heated externally by *exhaust-steam* in vessel I, and by *juice-steam* in vessels II and III, as explained in the previous chapter.

In the *Lillie Film Evaporator* (Fig. 25) the cylindrical vessel and enclosed heating-tubes are horizontal; a spray of juice falling upon the exterior surfaces of the tubes, which are heated internally by *exhaust-steam* in vessel I, and by *juice-steam* in all the following vessels. At any given moment, only a thin film of juice is in contact with each tube, this film being constantly renewed by means of a small centrifugal pump, which returns the juice (falling from the lowermost tubes) to the spray-pipes (above the tubes); each vessel of the multiple-effect having a separate pump for this purpose. The juice thus circulates repeatedly over the tubes in one vessel before it passes into the following vessel, where the circulation, heating, and evaporation continue. A Lillie Quadruple-effect is shown in Fig. 26. The patentees claim the following advantages:—

(1) The absence of hydrostatic pressure ensures a low boiling point (corresponding to the pressure (vacuum) in each vessel), and, consequently, the maximum *temperature-fall*.

(2) Rapid motion of the juice over the heating-surface ensures high evaporating power per sq. ft. of heating-surface, per hour, as indicated below:—

	<i>Film Evaporator.</i>	<i>Bulk Evaporator.</i>
Double effect	12 to 13½	8 to 9
Triple effect	9½ ,, 11	6 ,, 7
Quadruple effect	7 ,, 8	4½ ,, 5

(Illustrations of certain modifications of these evaporators, also details of the attached condensers and air-pumps will be found in Ware's *Beet Sugar Manufacture and Refining*, Vol. II, Part iv, chapters 2 and 3; and in Deerr's *Cane Sugar*, chapter 16.)

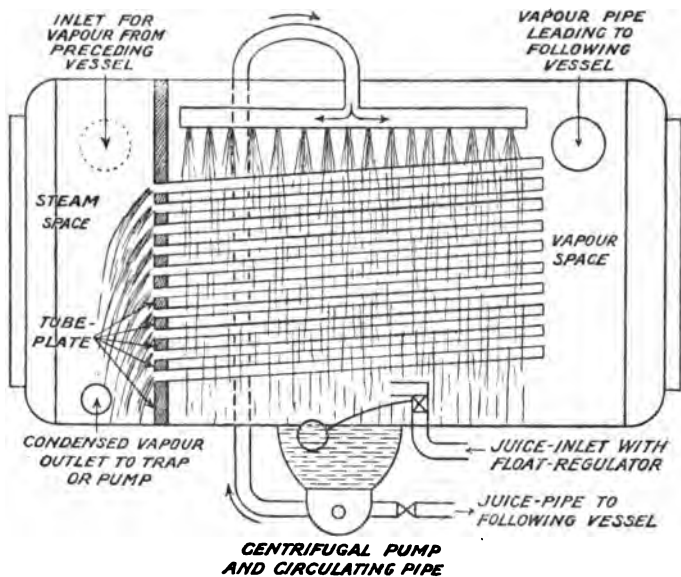

FIG. 25.—THE LILLIE FILM-EVAPORATOR¹
(Vertical Section of one Vessel)

Mode of operating a Multiple-effect Evaporator

The following description refers to a triple-effect bulk evaporator, shown in Fig. 24.

Starting.—The three empty vessels are brought into communication with each other, also vessel I with the juice-supply-tank, by opening the valves on the small juice-pipes connecting the lower parts of the vessels (Fig. 23). The air-pump is set in motion, and air exhausted from the three vessels simultaneously, juice entering from the supply-tank.

¹ By permission of The Sugar Apparatus Manufacturing Company, Philadelphia, Pa.

As soon as the inflowing juice approaches the level of the upper tube-plates, all the juice-valves are closed, thus isolating the lower portions of the three vessels; and the air-pump now acts only on the third, or last vessel. Low-pressure steam is admitted to the heating-chamber (calandria) of vessel I, causing the contents to boil, and the *juice-steam* thus generated enters the heating-chamber of II. Similarly, vessel II supplies *juice-steam* to the heating-chamber in III. A current of cold water is then admitted to the condenser to condense the *juice-steam* generated in III, and thus maintain the vacuum.

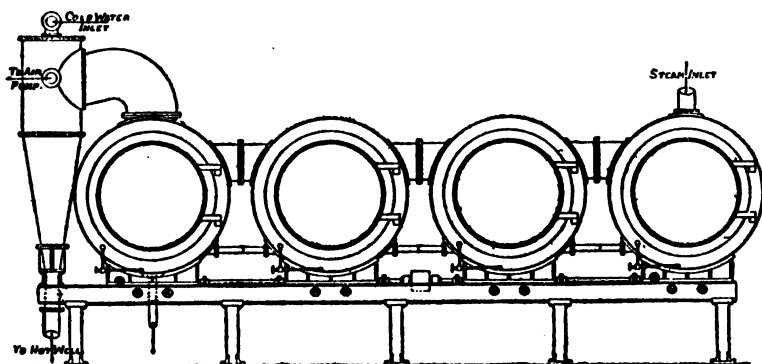

FIG. 26.—THE LILLIE QUADRUPLE-EFFECT EVAPORATOR¹
(Exterior View)

As evaporation proceeds, the level in III is maintained by transferring juice from II; similarly, the level in II is maintained by transferring juice from I; and the level in I, by drawing in fresh juice from the supply-tank; these transfers being effected by means of the juice-pipes and valves, referred to above. The level of the boiling juice in each vessel is observed through sight-glasses, and is so regulated that the upper tube-plate is always wetted by, yet not submerged in, the juice. The true level of the juice (if not boiling) would be about half-way up the heating-tubes, but, when boiling, the juice foams up the tubes and over the upper tube-plate.

Owing to the frequent transfers of juice from I to II, and

¹ By permission of The Sugar Apparatus Manufacturing Company, Philadelphia, Pa.

from II to III, the concentrated liquid (syrup) accumulates in III, and soon reaches the desired density (30° Beaumé). At the same time, the contents of I remain at a low density, being constantly diluted with fresh juice entering from the supply tank; and the contents of II attain a density lying between those of vessels I and III. Small samples of syrup are withdrawn from III by means of a testing apparatus attached thereto, and when the desired density is reached, a syrup-pump is started, and a continuous discharge of syrup maintained. The speed of the pump is so adjusted that the contents of vessel III remain at the desired density.

The evaporator has now been brought into normal working conditions, which are maintained as follows.

Routine Work.—The attendant has merely to regulate the flow of liquid from vessel to vessel, the supply of juice to vessel I, and the discharge of syrup from vessel III. When the valves on the various juice-pipes have been once adjusted, the entire apparatus operates automatically, and requires very little attention. To ensure high efficiency, the following details require to be attended to:—

(1) The "scale," which forms on the metal heating-tubes, must be periodically removed by scrapers provided for this purpose, after the vessels have been emptied. As the scale is very hard, it is usually necessary to fill the juice-space of each vessel with a 1% solution of caustic soda, heat this to boiling point, and leave in contact with the scale for a few hours. The scale is thus softened, and can then be detached by the scrapers.

(2) The juice should enter the first vessel at a high temperature, by avoiding excessive cooling between chemical treatment and evaporation.

(3) To maintain a high vacuum in the last vessel the air-pump must be sufficiently powerful, and the condensing-water sufficient in quantity, and at a suitable temperature. In most factories, the hot water escaping from the condenser is pumped to a cooling-tower outside the factory, whence it returns to the condenser. It is desirable to ascertain the temperature of the water entering the condenser from time to time.

(4) Air and incondensable gases (from the steam used, or from the boiling juice) must not be allowed to accumulate in the steam-drum of each vessel, but are drawn off by means of small tubes, and pass to the condenser. These gas- and air-outlets are called "ammonia pipes" because boiling beet-juice evolves a small quantity of ammonia.

(5) Condensed steam must be rapidly removed from the steam-drums; that in vessel I escapes through a steam-trap, but in the other vessels the condensed *juice-steam* must be removed by pumps, owing to the vacua in these steam-drums.

The method of operating a *film-evaporator* only differs from that described above in the quantity of liquid present in each vessel, and the forced circulation of the liquid by means of the centrifugal pumps.

When a multiple-effect is in full operation, the following conditions are found :—

- (a) A constant volume of liquid in each vessel.
- (b) The temperature and density of the liquid differ in different vessels, but are constant in any one vessel.
- (c) Tons of water evaporated = (tons of juice entering first vessel) — (tons of syrup leaving last vessel).
- (d) Tons actual sugar entering first vessel (in the form of juice) = tons of actual sugar leaving last vessel (in the form of syrup).
- (e) Quantity of heat, and quantity of actual sugar contained in the whole apparatus, remain constant.

TABLE IX.—TEMPERATURES AND VACUA IN MULTIPLE EFFECT

	Vessel I.	Vessel II.	Vessel III.
Vacua	2½"	14½"	26"
Temperature of entering steam →	220° F.	205° F.	183° F.
" " boiling liquid .	↓ 205° F.	↑ ↓ 183° F.	↑ ↓ 130° F. → Condenser
Temperature-fall in each vessel .	15° F.	22° F.	53° F.
Coefficient of heat trans- mission	British	6·8	3·5
	Metric	45	33

The temperatures existing in a triple-effect are shown in the above Table, although the conditions vary somewhat in different factories, according to the temperature of the

steam entering the first vessel, and the vacuum maintained in the last vessel. The coefficients of heat-transmission are taken from Claassen's observations. The downward arrows indicate heat-transmission, and the slanting arrows indicate the passage of steam from vessel to vessel.

The composition of cane syrup is given in Table XII (p. 285).

Heat Losses during Evaporation

When the triple-effect is in full operation, the heat losses may be measured by means of a thermal balance-sheet, as follows :—

$$\begin{array}{l}
 \text{Heat entering Evaporator.} \\
 \left. \begin{array}{l}
 (a) \text{ Total heat of steam entering vessel I.} \\
 (b) \text{ Sensible heat of juice entering vessel I.}
 \end{array} \right\} = \begin{array}{l}
 \text{Heat leaving Evaporator.} \\
 (a) \text{ Sensible heat of condensed steam leaving vessel I.} \\
 (b) \text{ Sensible heat of condensed juice-steam leaving vessels II and III.} \\
 (c) \text{ Sensible heat of syrup leaving vessel III.} \\
 (d) \text{ Total heat of juice-steam leaving vessel III and passing to condenser.} \\
 (e) \text{ Radiation losses.}
 \end{array}
 \end{array}$$

(1) *Heat entering Evaporator.*

(a) *Total Heat of Steam* (see p. 245).

(b) *Sensible Heat of Juice*.—If the temperature of the entering juice be less than the boiling point in vessel I, a portion of the total heat of the steam will be consumed in raising the temperature of this juice, and the evaporating power of the steam will be reduced proportionally.

If the juice enters at a higher temperature than the boiling point in vessel I, the excess of temperature causes "self-evaporation" (p. 245), and the efficiency of the evaporator is increased proportionally. Similarly, when juice is transferred from vessels I to II, and from II to III, the difference in boiling points causes "self-evaporation."

(2) *Heat leaving Evaporator.*

(a) *Condensed Steam leaving Vessel I.*

Let t_s = temperature of entering steam.

" t_w = " " condensed steam (water).

" t_j = " " juice boiling in vessel I.

Then, the loss of heat will be greatest when $t_w = t_s$, and least when $t_w = t_j$. In practice, t_w lies between t_s and t_j .

In the sugar factory, the condensed steam is usually pumped into the steam-boilers, so that the heat lost in the evaporator is recovered in the boilers.

- (b) *Condensed Juice-steam leaving Vessels II and III.*—This loss of heat is similar to that in vessel I. As these condensed vapours may contain traces of sugar (carried over, or “entrained”) they must be frequently tested for sugar if used as boiler feed-water, because small traces of sugar cause “priming” in the boilers, and give rise to acid products of decomposition, which corrode the boiler-tubes and plates.
- (c) *Syrup leaving Vessel III.*—No loss of heat occurs if the hot syrup passes direct to the vacuum pan, where it is further concentrated to “massecuite” by boiling. More generally, the syrup is stored in tanks, in order to allow suspended impurities to subside, or is first heated to boiling point, before subsidence. Some heat is lost by cooling during subsidence.
- (d) *Total Heat of Juice-steam leaving Vessel III* (see “total heat of steam,” p. 245).—For 100 parts of water evaporated in the multiple-effect, this loss of heat decreases as the number of vessels increases.
- (e) *Radiation Losses* include :—(a) heat radiated from the exterior surface of the evaporator, and (b) conduction, due to contact with the surrounding air; both losses being proportional to the difference in temperature between the surface of the evaporator and the atmosphere. When the radiation losses are expressed as a percentage of the total heat entering the apparatus per hour, they are inversely proportional to the size (or capacity) of the vessel. The vessels of a multiple-effect are usually of uniform size, but differ considerably in temperature; consequently, radiation losses decrease from the first

to the last vessel. By covering the exterior of the evaporator and vapour-pipes with non-conducting material (such as felt), the radiation and conduction losses are reduced to from 3 to 5% of the total heat entering the evaporator.

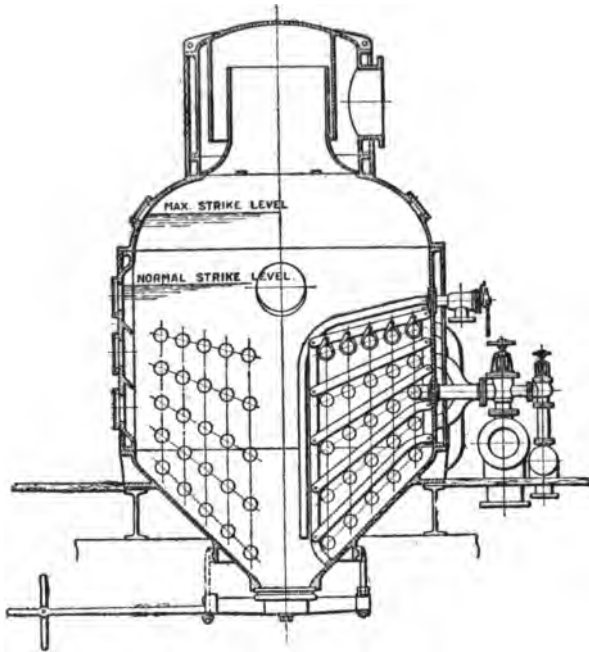

FIG. 27.—COIL-PAN¹

(b) CONCENTRATION OF SYRUP TO MASSECUTE

A considerable quantity of water must be evaporated from the syrup before the contained sugar begins to crystallise; and, as the temperature and degree of concentration must be carefully regulated, this second stage of evaporation is done by single-effect, or vacuum pan, invented by Howard in 1813.

A vertical section of a coil-pan is shown in Fig. 27, a large heating-surface being obtained by numerous steam-coils, about

¹ Illustration supplied by The Mirrlees Watson Company, Glasgow.

4 inches in diameter, arranged one above another. A different system of heating is adopted in the calandria-pan (Fig. 28), namely, a tubular steam-drum (resembling that in Fig. 23); the syrup circulating through the vertical tubes, 4 inches in diameter, whilst the heating-steam surrounds the tubes. Horizontal pans, having horizontal steam-tubes instead of coils, have been largely adopted in Continental beet-sugar factories.

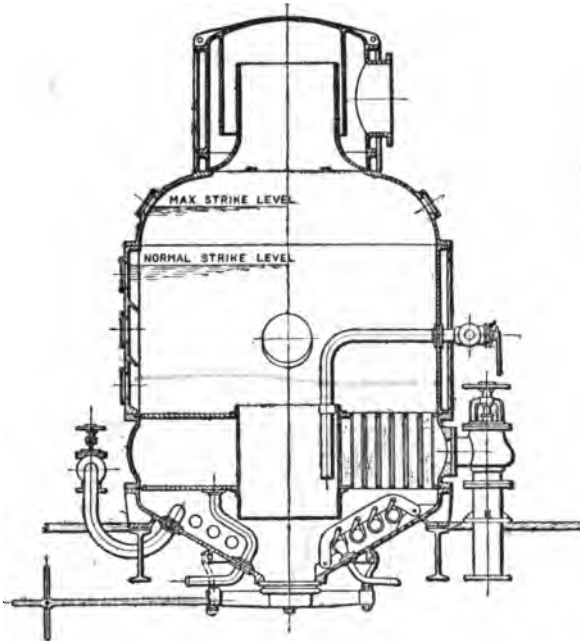

FIG. 28.—CALANDRIA-PAN¹

(Illustrations and detailed descriptions of these various types of pans will be found in the works previously mentioned.)

The following fittings are required for controlling the operations:—

(1) Feed-pipe, with regulating cock, for supplying syrup to the pan.

(2) Steam-valves, which permit each coil to be brought into action, when required. Generally, each coil is fitted with two

¹ Illustration supplied by The Mirrieles Watson Company, Glasgow.

valves, so that either high-pressure, or low-pressure steam can be used. The steam-drum of the calandria-pan may also have two steam-inlet valves for different pressures, and one steam-coil is usually placed below the steam-drum.

(3) Steam-pressure gauges, connected to each coil, or to steam-drum.

(4) Vacuum gauge on "dome" of pan.

(5) Sight-glasses, for observing the level of the boiling material.

(6) Proof-stick, for removing small samples of the boiling syrup for examination.

(7) Air-cock, for admitting air to the interior of pan after boiling is completed.

(8) Mechanism for opening and closing the discharge-gate at bottom of pan.

(9) Steaming-out cock, for blowing steam into pan in order to remove material adhering to the coils after the pan has been discharged.

(10) Water-valve, for controlling the flow of water through the condenser, and thus regulating the vacuum in the pan and boiling point of the syrup.

The evaporation of water from the syrup is accompanied by the formation and growth of crystals, but it will be convenient, at present, to regard the vacuum pan only as an evaporator, crystallisation being treated in the following chapters.

When first introduced, the Vacuum Pan was justly regarded as a fuel economiser, as compared with the former system of evaporation in open vessels, built into a flue, and heated by a fire. But fuel economy was no longer claimed for Howard's apparatus after Rillieux introduced his multiple-effect system. Yet, the vacuum pan has been indispensable for a century, and is not likely to be abandoned in the future; for, during the final stages of evaporation, fuel economy is of less importance than complete control over the crystallisation, and the single-effect affords greater facilities for such control than the multiple-effect.

In most cane-sugar factories, the vacuum pan is heated by boiler-steam, reduced to a pressure of 10 to 20 pounds per

sq. inch, and the vacuum pan then operates as a single-effect (see Fig. 29 opposite p. 360). But, in a few cane-sugar factories,* and in most beet-sugar factories, the heating-agent is *juice-steam* drawn either from the *Pre- evaporator*, or from the first vessel of the multiple-effect evaporator (see p. 253); the vacuum pan thus becoming the second vessel of a double-effect, with resulting fuel economy. The arrangement is shown in Fig. 30.

It is interesting to note that this combination of triple-effect

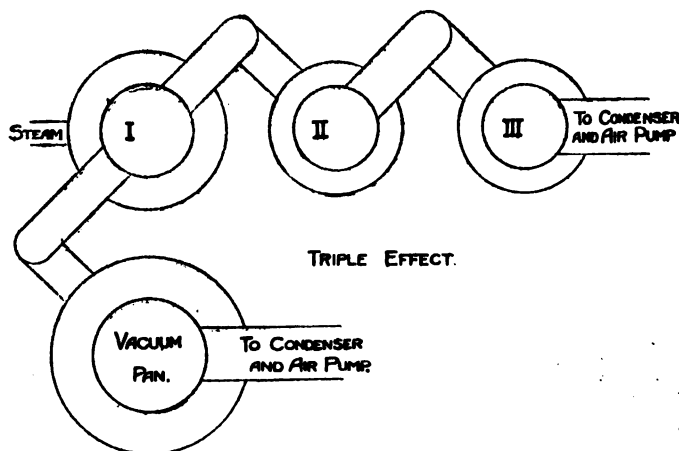

FIG. 30.—PLAN OF VACUUM PAN HEATED BY JUICE-STEAM FROM FIRST VESSEL OF TRIPLE-EFFECT

evaporation, and double-effect crystallisation, was a feature of the first multiple-effect apparatus designed by Rillieux.

During the evaporation of water, the viscosity of the syrup increases rapidly. The viscosities of pure solutions of sucrose were measured in an *Engler Viscosimeter* by Claassen, and his results are shown in the following Tables. The first column of Table X shows the proportions of sucrose to 100 parts of water in the solutions tested; the second column gives the number of seconds required for 100 c.c. of each solution to flow from the viscosimeter at a uniform temperature of 30° C.; and the third column gives the ratios obtained, taking the saturated solution as the standard (100).

TABLE X.—INFLUENCE OF CONCENTRATION ON VISCOSITY OF PURE SUCROSE SOLUTIONS

<i>Concentrations.</i> Grams of Sucrose per 100 grams of water.	<i>Rates of Flow.</i> Seconds per 100 cc.	<i>Viscosities at 30° C.</i>
100 (unsaturated)	22	13
219 (saturated)	164 = standard	100 (standard)
236 } (supersaturated)	248	151
256 }	373	227
270 }	464	283

Claassen further determined the influence of temperature on the viscosity by testing the above saturated solution at different temperatures, with the results given in Table XI.

TABLE XI.—INFLUENCE OF TEMPERATURE ON THE VISCOSITY OF SUCROSE SOLUTIONS

<i>Temperatures.</i>	<i>Rates of Flow (seconds).</i>
16° C.	476
30	164
42	86
61	39
71	30

It will be observed that the decrease in viscosity due to rise in temperature, is more rapid than the increase in viscosity due to increase in concentration. The viscosities of cane- and beet-syrups are considerably higher than those of solutions of pure sucrose, of equal density, owing to the presence of non-sugars of higher viscosity, such as pectin, gums, etc.

As the boiling temperature in the vacuum pan is fairly constant, the increase in concentration and viscosity of the syrup is accompanied by a decrease in transmission of heat per sq. ft. of heating surface. After crystals have been formed, and during their growth, the viscosity is no longer due to the concentration of the boiling syrup, but to the presence of the solid crystals, for the final product (massecuite) is semi-solid and contains about 65% of crystals, and only 35% of mother-liquor. The decreasing transmission of heat at

different stages of the evaporation was determined by Claassen, with the following results :—

	<i>British Coefficients of Transmission.</i>	<i>Metric Coefficients of Transmission.</i>
During concentration of syrup, before crystals are formed } =	3·7	18·0
During the subsequent growth of the crystals =	2·1	10·0
Final concentration, when the pan is filled =	0·8	3·7

The average coefficient during the whole period of boiling has been determined by Kerr, under factory conditions, with the following results :—

	<i>British Coefficients.</i>	<i>Metric Coefficients.</i>
Ordinary coil-pans	1·58	7·7
Pans with short coils, or "lyres"	2·41	11·8
Calandria-pans ("Express" type)	2·58	12·6

On comparing Claassen's coefficients for syrup in the vacuum pan, with those for juice and syrup in the triple-effect evaporator (p. 259), we obtain the following series :—

	<i>British Coefficients.</i>	<i>Temperature-falls.</i>
In triple-effect { low density juice	9·2	15° F.
{ high density syrup	3·5	53° F.
In vacuum pan { high density syrup (before crystallisation	3·7	about 100° F., but variable
{ during growth of crystals	2·1	
{ final concentration	0·8	

The juice-coefficient (9·2) represents B.T.U. transmitted per sq. ft. of heating-surface per minute, and per degree of temperature-fall. On multiplying by the actual temperature-fall (15° F.) we obtain a total of 138 B.T.U. transmitted per sq. ft. per minute. Similarly, the syrup-coefficient (3·5), multiplied by the actual temperature-fall (53° F.), gives a total of 186 B.T.U., transmitted per minute. The same

syrup, during further concentration in the vacuum pan, has a coefficient of 3·7, and temperature-fall of 100° F., or a total of 370 B.T.U. per minute. Up to this point, the syrup is free from crystals, and the total heat transmitted per sq. ft., per minute, is approximately proportional to the respective temperature-falls. But, the coefficients given in the Table clearly prove the higher efficiency of the heating-surface when treating the low-density juice than when treating syrup. After the formation of crystals, the heat transmitted gradually decreases from about 370 to about 80 B.T.U. per sq. ft. per minute.

The foregoing considerations point to the following requirements in a vacuum pan:—

- (1) Sufficient heating-surface, relative to the capacity of the pan.
- (2) High efficiency of this heating-surface.
- (3) Circulation of the boiling syrup over the heating-surface.

These will now be briefly considered.

(1) *Quantity of Heating-surface.*—This is limited by the following practical considerations:—(a) the space occupied by the heating-surface diminishes the working-capacity of the pan; and (b), the heating-surface obstructs the descent of the material, when discharging the pan.

In the coil-pan, the ratio is from 1·0 to 1·5 sq. ft. of heating-surface per cubic foot of working-capacity. The calandria-pan has the advantage of providing a larger heating-surface in a given volume than is possible when using coils, the ratio being increased to from 1·5 to 2 sq. ft. of heating-surface per cubic foot of working-capacity. The horizontal pan, with straight horizontal steam-tubes, gives a still higher ratio of about 2·5 to 3·0 sq. ft., per cubic foot working-capacity.

These ratios may also be expressed as follows:—

Coil-pan	=	1 sq. ft. of heating-surface per	60 to 90 lbs. massecuite.
Calandria-pan	=	" " " "	45 " 60 " "
Horizontal pan	=	" " " "	30 " 35 " "

Howard's original vacuum pan was heated by a steam-jacket, or double-bottom, but, when large pans were con-

structed, coils were substituted for the steam-jacket in order to obtain sufficient heating-surface. Modern pans are now frequently constructed with both forms of heating-surface.

(2) *Efficiency of the Heating-surface.*—This may be considered under two aspects:—(a) the form and position of the heating-surface, and (b) the *temperature-fall* acting through that surface.

(a) *Form and Position of the Heating-surface.*

Coils.—The condensed steam flows through the entire length of the coil, forming a non-conducting layer between the steam and the metal, and retarding the transmission of heat. To minimise this defect, the length of a coil should not exceed 200 times its diameter. The coils are arranged one above another, as shown in Fig. 27, being thus distributed vertically in the pan. The total heating-surface cannot be brought into action until all the coils become covered with the boiling syrup, during the gradual filling up of the pan.

Lyres, or groups of single loops, have been substituted for spiral coils, the loops being arranged concentrically in one plane, each loop having a separate steam-inlet, and condensed-steam-outlet. This ensures a more rapid escape of the condensed steam than if the separate loops were united to form a single coil. These groups of loops may be distributed vertically in the pan, in the same manner as coils. But, in the *Greiner Pan*, they are arranged very close together, and one above another, in the form of a vertical cylinder, several cylinders of different radii being arranged concentrically. The total heating-surface is thus concentrated within a small space near the bottom of the pan, and can be brought into action when the boiling commences.

Vertical Straight Tubes, or the *Calandria-pan* (Fig. 28).—The higher efficiency of this pan is due to:—(a) the vertical position of the tubular heating-surface, and (b) the shortness of the tubes (the length being only

about ten times the diameter). The condensed steam therefore escapes rapidly from the exterior surfaces of the tubes and drains off from the lower tube-plate. As the calandria, or steam-drum, occupies the lower portion of the pan, the total heating-surface can be brought into action when the boiling begins.

Horizontal Straight Tubes.—This type is represented in the Wellner-Jelinek *Horizontal Pan*. The steam enters groups of horizontal tubes which occupy the lower portion of the horizontal vessel, this lower part having a V-shaped cross-section. The whole of the heating-surface can be brought into action when boiling begins.

(b) *Efficiency due to Temperature-fall.*—The temperature of the boiling syrup is fixed by the vacuum under which the pan operates. Under average factory conditions, the boiling point is approximately 160° F., under a vacuum of $25''$. When the heating-agent is *boiler-steam* (reduced to 20 lbs. pressure) its temperature will be 260° F., and the temperature-fall becomes $260 - 160 = 100^{\circ}$ F. In the previous example of a triple-effect (p. 259), the temperature of the exhaust-steam entering vessel I was 220° F., and the boiling point of the syrup in vessel III was 130° F., under a vacuum of $26''$; giving a total temperature-fall of 90° F., and an average temperature-fall per vessel of $\frac{90}{3} = 30^{\circ}$ F. But, in the third vessel only, the temperature-fall was 53° F., or nearly half of that in the vacuum pan, under the conditions referred to above.

Pans have been constructed to use steam at a pressure of 50 lbs. (300° F.), with a view to increasing the temperature-fall, but such high temperatures are not advisable unless mechanical circulation is adopted, as local overheating may cause destruction of sucrose, with production of a dark-coloured masseculite.

When the vacuum pan is heated by *juice-steam* from the Pre-evaporator (p. 253), the temperature of this steam is about 240° F., giving a temperature-fall of $240 - 160 = 80^{\circ}$ F. In the beet-sugar factory, the rapid concentration of the syrup and formation of crystal is frequently effected by

means of *juice-steam* drawn from the first body of the multiple-effect evaporator, and having a temperature of 223° – 226° F. ; giving a temperature-fall of $226 - 160 = 66^{\circ}$ F. The boiling is then continued with live-steam (about 240° F.) in order to increase the temperature-fall when the massecurite becomes thick and viscid.

(3) *Circulation of the Syrup*.—What may be termed "*natural circulation*" is due to slight differences in temperature within the same bulk of syrup ; the hotter portions ascending from the coils or tubes, and inducing a downward current at other (cooler) points. This natural circulation is very effective before crystals have been formed or during the early stages of growth, but rapidly decreases when the crystals become larger. At this stage, artificial circulation is frequently resorted to, namely, (a) injecting compressed air, or low-pressure steam, into the lower part of the pan by means of a perforated coil, or (b) mechanical stirrers, in special pans, such as the following.

The *Freitag Pan* is an ordinary calandria-pan, having an Archimedian screw rotating in a central vertical channel of the steam-drum. The screw is attached to a vertical shaft, driven by gearing above the dome of the pan. The slow motion of the screw causes a downward current at the centre of the steam-drum, and an upward current through the numerous vertical heating-tubes.

The *Grossé Pan* is heated by coils, but has a central circulating screw, similar to that described above.

The *Reboux Pan* is a horizontal, cylindrical vessel, with central rotating shaft, carrying radial arms which slowly rotate between numerous groups of curved steam-heated tubes.

Evaporation Formulæ

The quantity of water evaporated from the syrup, and the quantity of massecurite obtained, may be calculated by the formulæ given on p. 252, by substituting B_s and D_s (Brix and density of syrup) for B_j and D_j (Brix and density of juice) ; also substituting B_M and D_M (Brix and density of massecurite) for B_s and D_s (Brix and density of syrup).

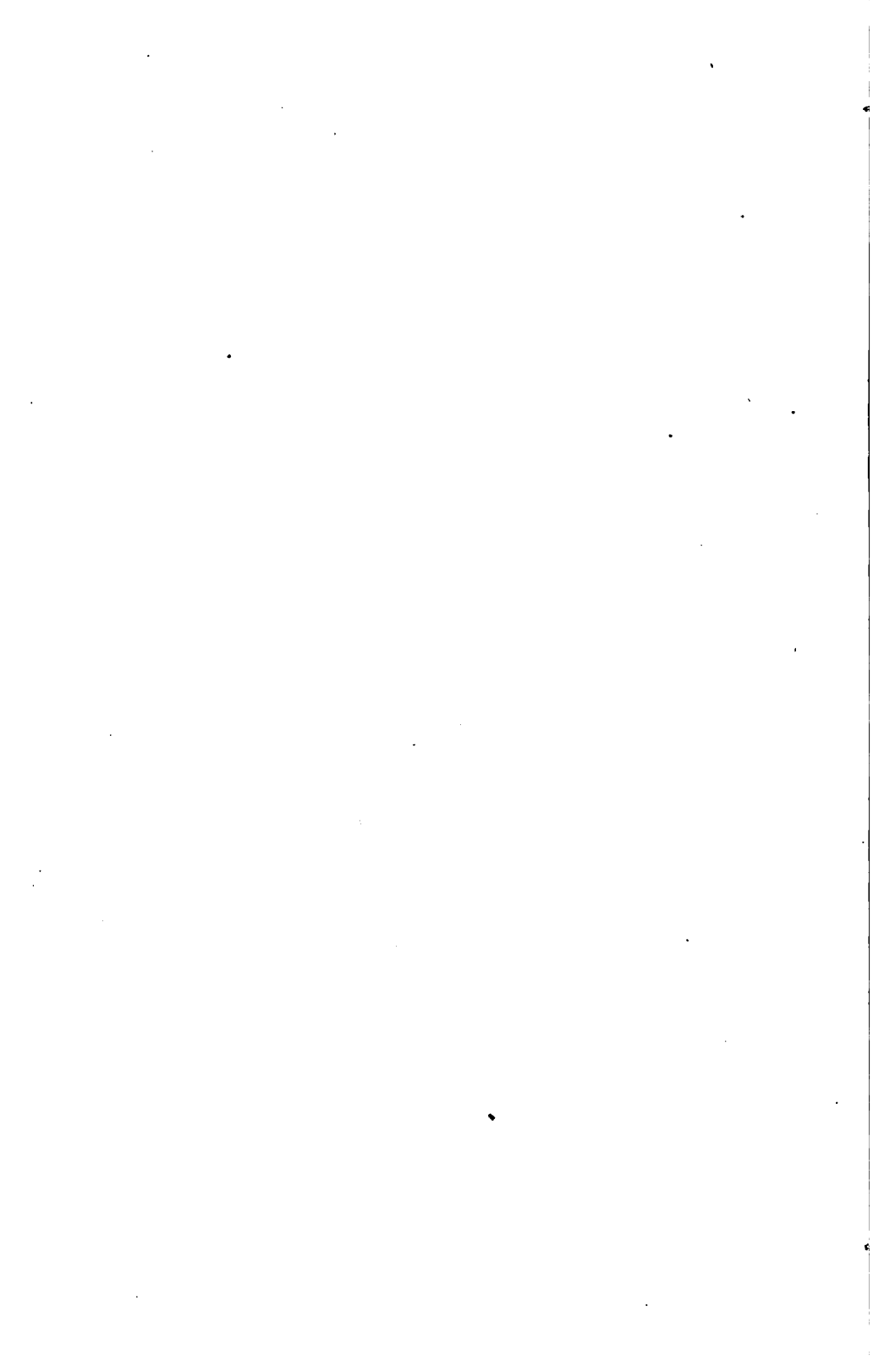

PART VII

CRYSTALLISATION

- CHAPTER 22. CRYSTALLINE FORMS—FORMATION AND GROWTH OF CRYSTALS
- „ 23. CRYSTALLISATION DURING BOILING IN THE VACUUM PAN
- „ 24. CRYSTALLISATION DURING COOLING AT REST, AND IN MOTION
- „ 25. SEPARATION OF THE CRYSTALS FROM THE MOTHER-LIQUOR—DRYING THE CRYSTALS
- „ 26. COMPLETE CRYSTALLISATION—CONTROL TESTS
- „ 27. EFFICIENCY OF CRYSTALLISING OPERATIONS

)

CHAPTER XXII

CRYSTALLINE FORMS—FORMATION AND GROWTH OF CRYSTALS

CRYSTALS are formed when various liquid and gaseous substances pass into the solid state; also, when solutions of many solid substances are concentrated and cooled. At the moment of solidifying, the molecules, although mutually attracted, unite in certain positions relative to each other; giving rise to a solid mass (crystal) possessing a definite external form, and a definite internal structure.

External Form.—A crystal is bounded by numerous planes, termed *faces*, and therefore has a certain shape. But the same substance frequently crystallises in different shapes, owing to some of the crystal-faces being enlarged, or diminished, relative to other faces on the same crystal. But, whatever be the shape, the angle at which two adjacent *faces* meet (forming an edge), remains constant for a given substance. The word "*form*," as applied to crystals, has a different meaning to the word "*shape*," because referring to the *relative positions* of the crystal-faces, disregarding their *relative areas*.

Crystalline forms have been classified under six systems, based on the number and direction of their axes, and certain relations of these axes to the crystal-faces; (the axes are imaginary lines passing through the crystal, in directions parallel to certain edges). The six systems are termed:—(1) cubic, or regular; (2) hexagonal; (3) tetragonal; (4) rhombic; (5) monoclinic; and (6) triclinic. Each system is capable of two or more modifications, giving rise to 32 classes or geometrical types, but which are not all represented in actual crystals.

Internal Structure.—This is very clearly indicated by the

property of "cleavage," or splitting along certain planes which are parallel to certain faces. Similarly, the optical, thermal, and electrical properties of crystals vary in intensity in different directions through a crystal, but are constant in directions which are parallel.

Sucrose Crystals belong to the monoclinic system, characterised by three axes of unequal length, two lying in one plane, but not parallel, whilst the third axis is at right angles to the above-mentioned plane. The form of the sucrose crystal varies slightly when formed under different conditions, but such modifications all belong to the monoclinic type.

Crystals of granulated sugar, obtained by rapid evaporation of water in the vacuum pan, are thin rectangular plates, with bevelled edges; the bevels being very narrow *faces*. Two plates are generally united, side by side, forming a "twin-crystal"; the joined bevelled edges forming a shallow groove across the double-plate. Poisson states that this twin-crystal is only formed when the solution contains glucose, in addition to sucrose. The form of the crystal may be greatly modified when the solution contains raffinose, being then elongated, or needle-shaped.

The normal form of the sucrose crystal is found in sugar-candy; namely, an oblique prism, with rectangular or rhomboid base; but the crystals grow in clusters, instead of forming separate crystals. The physical properties of the sucrose crystal are given in Table I, on p. 109.

Formation of Crystals

A solution of a crystallisable substance can only yield crystals when it is *supersaturated*; this condition being produced by either of the following methods, both of which are employed in the sugar factory.

Method (a).—By slowly cooling a hot, *saturated* solution; thereby reducing the solubility of the dissolved substance up to the point where crystals begin to separate.

For example, a solution of pure sucrose in water, saturated at a temperature of 70°C ., contains 76.22% of sucrose, and 23.78% of water; or, one part of water can dissolve 3.21 parts of sucrose. On slowly cooling this solution to 30°C ., the

solubility of sucrose should fall to 2.19 parts per unit of water present, accompanied by the separation of crystals. But, if no crystals separate, the solution would become supersaturated at 30° C., to the *degré* of $3.21 - 2.19 = 1.02$ of sucrose per unit of water. The *Coefficient of Supersaturation* is defined as:—the ratio of the normal solubility, at a given temperature, to the solubility of the supersaturated solution, at the same temperature. In the above case, the *Coefficient of Supersaturation* = $\frac{3.21 \text{ at } 30^\circ \text{ C.}}{2.19 \text{ at } 30^\circ \text{ C.}} = 1.47$.

Method (b).—By evaporating the liquid from the saturated solution, without any change of temperature, until the ratio solid/liquid exceeds the normal solubility of the solid at this constant temperature, up to the point where crystals begin to separate.

For example, the same saturated sucrose solution at 70° C., (method (a)), is boiled at this temperature in a vacuum pan until the ratio $\frac{\text{sucrose}}{\text{water}} = \frac{4.72}{1}$. As the normal solubility of sucrose at 70° C. is in the ratio $\frac{3.21}{1}$ (see above), sucrose crystals should now separate. But, if no crystals separate, the *degré of supersaturation* will be $4.72 - 3.21 = 1.51$ of sucrose per unit of water, and the *Coefficient of Supersaturation* will be $\frac{4.72 \text{ at } 70^\circ \text{ C.}}{3.21 \text{ at } 70^\circ \text{ C.}} = 1.47$.

On comparing the two methods, it will be seen that *different degrés* of supersaturation, namely, 1.02 and 1.51 at two *different temperatures*, 30° and 70° C., may yet give *equal coefficients*. This is equally true for different temperatures by one and the same method (either (a) or (b)), thus proving that the *Coefficient of Supersaturation* is independent of temperature.

A supersaturated solution is therefore in an abnormal or unstable condition, having a tendency to deposit crystals, yet not readily undergoing the physical change from the fluid state (dissolved solid) to the solid state (crystal). The solution may even remain supersaturated for a long period if left

undisturbed, and at a constant temperature, but violent shaking may cause rapid crystallisation. A highly supersaturated and cold solution of sodium sulphate is suddenly transformed into a solid mass of minute crystals on shaking, or on adding a single crystal of this salt. Similarly, if a small quantity of powdered sugar be added to a supersaturated sugar solution, the added crystalline particles will "excite" crystallisation of the solution, sugar thus separating by depositing on the added particles, which therefore grow. This growth continues until the liquid loses its supersaturated condition, and becomes a normally saturated solution, incapable of further crystallisation.

Growth of Crystals

When crystals have been deposited from (or added to) a supersaturated solution, further crystallisation proceeds more readily, as explained above, and at a rate proportional to the *Coefficient of Supersaturation*. If this coefficient remains high (due to rapid cooling in method (a), or rapid evaporation of the liquid in method (b)) new crystals are formed from time to time, and the first-formed crystals grow but slightly. If, on the other hand, a low coefficient be maintained (by slower cooling, or slower evaporation), the first-formed crystals grow continuously, and no additional crystals are formed.

The foregoing facts indicate that the *Coefficient of Supersaturation* must be higher in order to *produce* crystals than during the subsequent *growth* of these crystals; although the two processes—formation and growth—are included in the term *crystallisation*. Thus, Claassen's study of the crystallisation of beet syrup in the vacuum pan led him to the following conclusions.

In order that crystals may be formed (*graining-point*), the syrup should have a *coefficient* of about 1.5; for, if the *coefficient* be as low as 1.2, the minute crystals may dissolve when fresh syrup (unsaturated) is drawn into the pan. During growth, the *coefficient* may be reduced to 1.1, thereby avoiding the formation of new crystals (*false grain*). As soon as the crystals become well developed, the *coefficient* should be gradually increased to 1.3 by the time the pan is filled.

Size of Crystals

The growth of a crystal does not modify its form, provided that its numerous *faces* are equally exposed to the solution in which growth is taking place. But when crystals adhere to each other, or to the crystallising vessel, only the exposed *faces* can grow, and the crystal-form may be thus distorted.

Large crystals are produced by maintaining a very low *Coefficient of Supersaturation* for a long period (as in the manufacture of sugar-candy), by very slow evaporation of water at a constant temperature, or by very slow cooling of a hot, saturated solution. The factors which limit the size of sucrose crystals during rapid evaporation of water in the vacuum pan, are considered in the following chapter (p. 283).

CHAPTER XXIII

CRYSTALLISATION DURING BOILING IN THE VACUUM PAN

(a) SYRUP

THE boiling operation, although continuous, comprises the following stages :—

(1) Rapid evaporation of water until crystals begin to separate.

(2) Growth of the crystals, by frequent additions of syrup, and continued evaporation of water after such additions.

(3) Final concentration, to reduce the fluidity of the crystallised syrup before it is discharged.

Each of these stages will be considered, and numerous technical terms introduced in italics.

(1) *Concentration of Syrup "to Graining-point."* After air has been exhausted from the vacuum pan, sufficient syrup is drawn in to cover the lower coils, and steam admitted to these coils. As evaporation proceeds, the level is maintained by drawing in small charges of syrup from time to time, each charge being followed by concentration. When this has continued for a short time, samples of syrup are removed by means of the *proof-stick* (p. 264), poured upon a glass plate, and the film of syrup examined in front of a lamp-flame. A sparkling appearance indicates the formation of crystals (*graining-point*), the crystals being too minute to be seen individually.

The number of crystals (*quantity of grain*) thus formed should yield an equal number of fully-grown crystals when the boiling is completed. Thus, if x = number of crystals, and y = weight of sugar crystallising from the syrup during the whole boiling operation, each fully-grown crystal would weigh $\frac{y}{x}$. In other words, the size of the fully-grown crystals

is inversely proportional to the number of minute crystals produced at the "*graining-point*."

A small number is formed by starting with a small volume of syrup (*graining low down in the pan*); and a large number, by starting with a large volume of syrup (*graining high up in the pan*). The empty space remaining in the pan is available for the growth of the grain by the gradual addition of syrup, and deposition of the contained sucrose upon the grain already formed (*building up the grain*).

The *Coefficient of Supersaturation* at the *graining-point* varies inversely with the purity of the syrup, and determines the number of crystals formed per unit volume of syrup. If this number be too small, new crystals (*false-grain*) appear at a later stage of the boiling. If the *grain* be too numerous they may fail to grow sufficiently by the time the pan is filled. Long experience is necessary in order to produce the right quantity of grain to yield fully-grown crystals of a desired size. Impure syrups require a higher *Coefficient of Supersaturation* before yielding sufficient grain, and it is sometimes necessary to suddenly lower the temperature in the pan (*forcing the grain*) as follows:—

- (a) by increasing the vacuum (running more cold water through the condenser), thus lowering the boiling-point; or
- (b) by drawing in a rather large charge of the (colder) syrup, from the supply-tank.

The effect of such treatment is carefully observed by examining frequent samples from the *proof-stick*, and, as soon as the quantity of grain appears satisfactory, the former temperature is restored, thus preventing further formation of grain.

(2) *Growth of the Crystals*.—The grain grows by attracting (or fixing) sugar from the supersaturated syrup already present in the pan, and also from that subsequently introduced and concentrated, growth continuing until the pan is filled. Steam is admitted to each coil in turn, as soon as it becomes submerged in the boiling syrup, during the gradual filling of the pan.

Two objects must be kept in view, namely, uniform growth of the grain, and absence of false-grain. The former depends on free circulation of the boiling syrup, the individual crystals being kept in motion, and thus freely exposed to the syrup. This is secured by adding fresh syrup at suitable intervals, (*feeding the pan*), the crystals being thus separated from each other by a transparent mother-liquor (*keeping the grain open*), thus allowing the crystals freedom of motion.

During their growth, the rate of evaporation (hence also the rate of crystallisation) should be proportional to the number of crystals present; or, more exactly, to the total surface-area of the crystals present. If the quantity of sucrose separating from the syrup per minute be greater than this total surface-area can receive and "fix," the supersaturation of the syrup will rise once more to *graining-point*, and false-grain be formed. This is easily detected by the sparkling appearance of the mother-liquor between the original crystals (*true-grain*). The *false-grain* must now be dissolved, either by raising the temperature (*i. e.* lowering the vacuum), or by drawing in a small quantity of hot water or dilute syrup. If allowed to remain, the *false-grain* commences to grow, and arrests the growth of the *true-grain*.

The rate of evaporation, relative to the surface-area of the growing crystals, may be illustrated as follows. Two exactly similar pans, A and B, are treating the same syrup, but the quantity of grain formed in A is only about half that in B, and therefore represents a much smaller surface-area upon which sugar can deposit. The rate of evaporation in A must be slow in order to avoid further grain-formation during the growth of the *true-grain*, and to allow the relatively small number of crystals to grow rapidly; the time available for their growth being determined by:—(a) the slow rate of evaporation, and (b) the large empty space in the pan when the grain was formed (by *graining low down*).

As pan B contains twice the quantity of grain, more rapid evaporation is possible without false-grain being formed. The sugar separating per minute from the boiling syrup being here distributed over a very large number of crystals (*i. e.* large surface-area), growth is very slow, and the time

available for growth is reduced by:—(a) the higher rate of evaporation, and (b) the smaller empty space in the pan when the grain was formed (by *graining high up*).

As time is an important consideration, the more rapid method B is largely adopted, because further growth of the crystals can be effected as follows. One-half of the contents of pan B is discharged (*cutting the pan*); this portion (*the first cut*) being treated in centrifugals (*cured*), and separated into small-grained crystals, and fluid molasses. The other half, left in the pan, is boiled with fresh additions of syrup, causing further growth of the crystals until the pan is again filled. Half the contents may, again, be discharged (*second cut*), and *cured*, and the remainder boiled with fresh additions of syrup until the pan is filled a third time; when the entire contents may be discharged (*striking out the pan*). In this case, two *cuts* and one full pan (*strike*) are derived from one *graining* operation. The boiled, crystallised syrup is termed *massecuite* (from the French “*masse cuite*” or boiled product).

Instead of the above method of *cutting*, half the original contents of pan B may be transferred to an empty pan C by means of a wide-bore connecting-pipe with valve. The two halves are then boiled separately, with additions of syrup, until both pans are filled (*doubling the strike*).

The above re-boilings of the *same grain* cannot be repeated indefinitely for the following reason. Growth of crystals is accompanied by an increasing viscosity and diminishing circulation of the boiling *massecuite*, so that different temperatures occur at different points. The density and supersaturation of the mother-liquor are no longer uniform, and new crystals (*false-grain*) are formed locally where the degree of supersaturation is excessive. The growth of the *false-grain* prevents further growth of the original, or *true-grain*.

(3) *Final Concentration*.—During the gradual filling of the pan, the *massecuite* is kept fluid in order to assist the circulation, and to ensure uniform growth of the crystals. A final concentration (*tightening the grain*) is necessary to reduce the percentage of water, and thus obtain the maximum crystallisation of the mother-liquor. The degree of this final

concentration is mainly determined by the time required to empty the pan, and this varies with the design of the pan itself, and with the diameter of the discharge-opening at bottom. As the pan is inactive during the period of discharging, it is obviously desirable to reduce this period, and to rely on the subsequent boiling of the mother-liquor (separated in the centrifugals) to complete the crystallisation.

Taking these factors into account, a proof-stick sample of the massecuite is drawn from the full pan and immersed in cold water to cool it, and its consistency ascertained by pressure between the fingers and thumb. When the desired firmness has been obtained, steam is shut off from all the coils, the air-cock is opened (*breaking the vacuum*), and the discharge-gate opened. After discharging, steam is blown into the interior of the pan, where it condenses, causing the residual massecuite to fall from the metal surfaces (*steaming out the pan*). The discharged massecuite (*strike*) then passes to the centrifugals for further treatment (Chapter XXV).

If the pan is to be "cut," half the contents are discharged, the vacuum re-formed, and the boiling continued. If the strike is to be "doubled," a valve is opened on the large-bore pipe connecting the full pan to a second, empty pan, after a vacuum has been formed in the latter. The atmospheric pressure, acting on the first pan, forces the massecuite through the connecting-pipe, and, when a sufficient quantity has been transferred, the valve is closed and the two pans operated independently.

Composition of the Massecuite.—The following analyses of syrup and massecuite are calculated from that of the cane juice, shown on p. 127, by assuming that only water is removed, leaving the dissolved solid matters quite unchanged. Therefore, the three materials have the same purity, as shown.

Column 3 gives the percentage composition and purity of the massecuite; column 4 gives the ratio of crystals to mother-liquor (in this massecuite) when discharged from the pan; and column 5, the percentage composition and purity of the hot mother-liquor.

TABLE XII.—COMPOSITION OF SYRUP, MASSECUITE, AND MOTHER-LIQUOR DERIVED FROM CANE JUICE

	Juice.	Syrup.	Massecuite.	Massecuite.	Mother-liquor (hot).
Water . . .	83.0	45.00	8.0	} Mother-liquor Crystals = 44 56 100	} Water . . . 18.2 Sucrose . . . 57.2 Reducing sugars 12.3 Organic non-sugars . . . 6.1 Mineral matters 6.1 100.0
Sucrose . . .	15.0	48.52	81.18		
Reducing sugars	1.0	3.24	5.42		
Organic non-sugars . . .	0.5	1.62	2.70		
Mineral matters	0.5	1.62	2.70		
	<u>100.0</u>	<u>100.0</u>	<u>100.0</u>	<u>100</u>	<u>100.0</u>
Total dry solids or (100-water per cent.) . .	17.0	55	92		81.8
Purity . . .	$\frac{15 \times 100}{17} = 88.2$	$\frac{48.52 \times 100}{55} = 88.2$	$\frac{81.18 \times 100}{92} = 88.2$		$\frac{57.2 \times 100}{81.8} = 69.9$

When such a massecuite is allowed to cool, additional sugar crystallises from the mother-liquor, and the cold massecuite would contain from 60 to 65% of crystals, and from 35 to 40% of mother-liquor, of lower purity than 69.9.

The weight of water evaporated from the juice in the multiple-effect evaporator to produce the syrup = $\frac{100(55-17)}{55}$
 = 69.1% on juice (see p. 252), or $\frac{69.1 \times 100}{83} = 83.2\%$ of the total water (83.0%) in the juice. The additional water evaporated from the syrup in the vacuum pan to produce the massecuite = $\frac{100(92-55)}{92} = 40.2\%$ on syrup (see p. 271), or $\frac{40.2 \times 100}{45} = 89.3\%$ of the total water (45.0%) in the syrup.

The composition of massecuite boiled from beet juice is similar to that from cane juice, but reducing-sugars are absent, and the organic non-sugars somewhat higher.

(b) MOLASSES

The separation of the crystals from the mother-liquor will be described in Chapter XXV, and the fluid so obtained is known by the following names:—"first molasses," or "rich molasses" in the British Colonies; "égout" in France; and "nach-produkt" (= after-product) in Germany. By further

evaporation of water in the vacuum pan this material becomes highly supersaturated and yields a second crop of crystals, either during boiling in the pan, or during subsequent cooling in suitable vessels.

When a molasses is too impure to crystallise during boiling, it is merely concentrated to a suitable consistency ("*boiled blank*" or "*boiled smooth*") and discharged into suitable vessels (*coolers* or *crystallisers*) in which the crystals form and grow during cooling, as described in the following chapter.

CHAPTER XXIV

CRYSTALLISATION DURING COOLING AT REST, AND IN MOTION

THE *syrup-massecuite* when discharged from the vacuum pan has a temperature of 62° – 65° C. (143° – 150° F.), and massecuites boiled from molasses have a temperature of 65° – 70° C. (150° – 158° F.). The former product usually passes direct to the centrifugals, and is "*cured hot*"; but the latter is usually first cooled, in order that additional sugar may crystallise before curing.

The effect of cooling is twofold, namely:—(a) retarded crystallisation, due to the supersaturated condition of the hot mother-liquor; and (b) additional supersaturation due to fall in temperature.

(a) *Retarded Crystallisation*

A massecuite is discharged from the vacuum pan as soon as sufficient water has been evaporated, although crystallisation may not yet be complete. The hot mother-liquor is usually supersaturated, and can therefore cause further growth of the crystals *without any cooling*. The subsequent crystallisation, although apparently due to cooling, is largely due to retarded crystallisation, especially if the massecuite be of low purity. Thus, one of 65 purity does not crystallise during boiling, but only during cooling; crystallisation being entirely retarded, and the weight of crystals obtained after cooling is proportional to the *coefficient of supersaturation* at the moment of leaving the pan, and is not proportional to the fall in temperature during cooling. The much purer massecuite boiled from syrup of, say, 86 purity, crystallises freely during boiling; yet, as the hot mother-liquor is always

slightly supersaturated, crystallisation can continue after discharging the pan, and without fall in temperature.

(b) *Crystallisation due to Fall in Temperature*

Taking the vacuum-pan temperature as 158° F. (70° C.), and the cooled temperature as 104° F. (40° C.), 1 part of water dissolves 3·2 parts of sucrose at the first temperature, and 2·38 parts of sucrose at the second, so that 0·82 parts of sucrose per unit of water are capable of crystallising between the two temperatures. Then, if the massecuite contains 80% water, $0\cdot82 \times 8 = 6\cdot56$ parts of sucrose might be expected to crystallise, under the same fall in temperature, per 100 of massecuite. But, since a part of this 8·0% of water remains in the final, or uncrystallisable molasses, the crystallisation due to fall in temperature is very much less than the calculation indicates.

It may therefore be said that cooling allows sufficient time for *retarded crystallisation* to become complete; especially when treating massecuites of high viscosity. This retarded crystallisation is, however, supplemented by some additional supersaturation directly due to the fall in temperature. It is not desirable to cool the massecuite below 40°–45° C. because the viscosity of the mother-liquor increases rapidly at lower temperatures.

COOLING AT REST

When a crystallised *syrup-massecuite* is allowed to cool in tanks, or cisterns, the rate of cooling is greater at the surface and sides than towards the centre; consequently, a large quantity of *false-grain* is formed, and the *true-grain* tends to subside, leaving a layer of supersaturated mother-liquor at the surface. After cooling, the *true-grain* becomes cemented together by a glutinous mixture of mother-liquor and *false-grain*, forming a hard mass, which must be broken up in a special machine (*pug-mill*) before it can be treated in the centrifugals. Moreover, the *false-grain* is deposited in the interstices between the *true-grain*, thus retarding the escape of the mother-liquor from the centrifugal basket. A large part of this false-grain escapes through the centrifugal liners, along with the molasses.

Again, when a *smooth-boiled* massecuite is cooled in tanks, the same unequal rate of cooling causes different portions of the fluid mass to *grain* at different periods in one tank, the final result being an excessive quantity of small grain, which fails to grow; causing difficulty in separating the mother-liquor in the centrifugals. False-grain is unavoidable when massecuities are cooled at rest, unless the operation is conducted in hot-rooms, where the temperature can be regulated.

COOLING IN MOTION

The above-mentioned defects are avoided by keeping the massecuite stirred in special vessels, or *crystallisers*. These are horizontal cylindrical vessels, each having a central rotating shaft, with radiating arms and attached stirrers; the shaft and stirrers making about one revolution per minute, and being driven by gearing outside the crystalliser. The capacity of each crystalliser is usually equal to, or slightly larger than that of the vacuum pan, so that each *strike of massecuite* may be treated separately. The number of crystallisers (N) is calculated as follows:—

If H = hours during which the massecuite should be cooled.
 C = cubic feet capacity of one crystalliser.
 M = cubic feet of massecuite discharged from vacuum pans in H hours.

$$\text{Then } N = \frac{M}{C}.$$

This number will be constantly full, so that two more must be provided to allow for one filling and another discharging.

The motion of the massecuite causes:—(a) uniform temperature throughout the massecuite at any given moment; (b) uniform distribution and constant motion of the crystals in the mother-liquor; (c) uniform growth of the crystals; and (d) uniform concentration and temperature of the mother-liquor at any given moment, during the entire period of cooling.

The rate of cooling depends on two factors, namely:—

(a) The difference in temperature between the massecuite and the surrounding air.

(b) The volume of massecuite, relative to the external-area of the crystalliser.

These may be briefly considered:—

(a) The difference in temperature and the rate of cooling are greatest when cooling begins, decreasing as the difference in temperature falls. But, theoretically, the rate of cooling should be very slow at first, then gradually accelerated; in other words, should be inversely proportional to the degree of supersaturation of the fluid present in the massecuite.

(b) The external surface-area (or *cooling-surface*) of the crystalliser, per cubic foot capacity, decreases rapidly with increase in the diameter, so that the initial or *maximum rate* of cooling may be reduced to 0.5° – 1° C. per hour when operating on a large scale, as shown by the following temperatures, recorded by Geerligs. Initial temperature when discharged from vacuum pan = 69° C.; after cooling for six hours = 64° ; after twelve hours = 60° ; and after twenty-four hours = 52° C. The rate of cooling per hour is therefore 0.83° , 0.75° , and 0.71° respectively. It is sometimes retarded by circulating warm water through a "jacket" surrounding the crystalliser.

It is important to note that a given massecuite yields the same weight of sugar crystals when cooled at rest as when cooled to the same temperature in motion, but the practical results are very different. For, as explained above, cooling at rest produces a large quantity of *false-grain*, much of which is lost during centrifugal treatment; whereas, cooling in motion causes continued growth of the *true-grain*, and the whole of the crystallised sucrose is recovered in the centrifugals in the form of coarse crystals, of high purity.

Another important feature of cooling in motion is the fluidity of the cooled massecuite which can flow from the discharge-gate of the crystalliser to the centrifugals (on a lower floor); or can be pumped through large-bore piping when the crystallisers and centrifugals are on the same floor.

Types of Crystallisers

(1) *The Open Type* is a semi-cylindrical, horizontal vessel, of U-section, with revolving shaft and spiral stirrers. Detachable covers may be used in order to reduce the initial rate of cooling, these covers being removed later in order to

accelerate the cooling by exposing the upper surface of the massequite to the air. The continuous motion prevents any local cooling at the exposed surface.

(2) *The Semi-open Type* is a cylindrical, horizontal vessel, on the top of which is an open slot extending from end to end, enabling the massequite to be kept under observation with very little exposure to the air. It is fitted with spiral stirrers, as in the open type, and may also have detachable covers.

(3) *The Closed Type* is an air-tight, cylindrical vessel, otherwise closely resembling the semi-open type, but having the following connections:—

- (a) A large-bore pipe connecting the top of the crystalliser to the discharge-gate of the vacuum pan.
- (b) A second large-bore pipe connecting the discharge-gate of the crystalliser to the "mixer," which feeds the centrifugals.
- (c) A smaller pipe connecting the top of the crystalliser to the air-pump, attached to the vacuum pan.
- (d) A pipe connecting the top of the crystalliser to an air-compressor.

When the vacuum pan is ready to discharge, air is admitted to the interior of the pan, and partially removed from the interior of the crystalliser by pipe (c). A valve is opened, and the contents of the pan forced through pipe (a) into the crystalliser by atmospheric pressure, in much less time than when the pan is discharged by gravity. After being cooled in motion, the massequite is forced through pipe (b) to the centrifugals by means of compressed air entering the top of crystalliser by pipe (d).

(4) *Jacketed Crystallisers*.—Types (2) and (3) are sometimes constructed with double walls, forming a "jacket," through which warm water circulates when cooling begins in order to reduce the initial rate of cooling when the air-temperature is low. Cold water may be afterwards circulated through the jacket in order to accelerate the final stages of cooling, but this is rarely done.

(5) *Water-coils or Tubes*.—Ragot and Tourneur employ

helical coils mounted on a central rotating shaft for the double purpose of stirring the massecuite, and also heating, or cooling it; hot or cold water circulating through the coils whilst they are in motion. In the Huch Crystalliser the water-tubes are straight and rigid, extending across the vessel at right angles to its axis, and the stirring-paddles rotate between groups of these tubes. Each group of tubes projects through the cylindrical walls of the vessel, and terminates in an inlet- and outlet-chamber connected by piping to similar chambers on the same crystalliser.

Whichever type of crystalliser is employed, the vessels are arranged close together, and parallel to each other, so that the rotating shafts of the separate vessels can be driven from a single line-shafting. The massecuite, when discharged, falls into a sloping gutter extending below the vessels. A wooden platform may be erected over types (1) and (2) in order to inspect the massecuite during treatment. Pipe connections are also required for adding hot molasses to any one crystalliser, in case the massecuite should become too stiff during crystallisation.

The methods of using the crystallisers will be fully considered in Chapter XXVI.

CHAPTER XXV

SEPARATION OF THE CRYSTALS FROM THE MOTHER-LIQUOR—DRYING THE CRYSTALS

CENTRIFUGAL FORCE

A BODY, of mass m , moves in a circle of radius r , with uniform speed or linear velocity v .

$$\text{Centrifugal force} = \frac{mv^2}{r} \dots \dots \dots (1)$$

This is demonstrated in Fig. 31. When the body is at the point P, it tends to move along the tangent PP'; and, on reaching a second point Q, it tends to move along the tangent QQ'. From a point A, draw AB parallel to PP', and AC parallel to QQ'; making the lengths AB and AC represent the uniform speed v at the two points P and Q, and at all other points in the circle. Then, the length BC represents the change in direction of the motion on passing from P to Q, in time t . During this time, the radius OP sweeps through the angle POQ (equal to the angle BAC). Calling this angle θ , the distance between P and Q = θr .

Then, Linear velocity = $v = \frac{PQ}{t} = \frac{\theta r}{t} \dots \dots \dots (2)$

and change in direction of motion = $BC = AB\theta = v\theta \dots \dots \dots (3)$

From (2) $\theta = \frac{vt}{r}$, and substituting this value in (3)

$$BC = \frac{v^2 t}{r},$$

\therefore change in direction of motion per unit of time =

$$\frac{BC}{t} = \frac{v^2}{r}.$$

BC is parallel to a line OD bisecting the angle POQ. By making the distance PQ extremely small, this bisecting line approaches to a line joining the moving body to the centre of

rotation. Hence, the change in direction of motion at point P produces a strain along OP, and at point Q, along OQ, and at all other points in the circle. As this strain is proportional to the mass *m* of the moving body, we obtain :—

$$\text{Centrifugal force} = \frac{mv^2}{r} \dots \dots \dots (1)$$

As $\frac{1}{r}$ represents the *curvature of the path* of the moving body, the force is measured by the product of mass \times curvature of path \times square of linear velocity. The force increases directly with the curvature of the path (reduction of *r*), but increases much more rapidly with increase in linear velocity *v*.

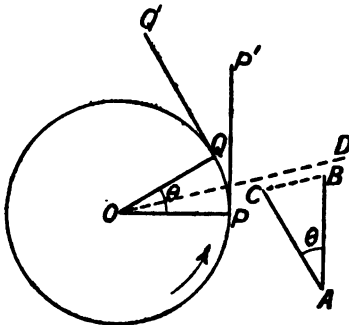

FIG. 31.—LINEAR VELOCITY

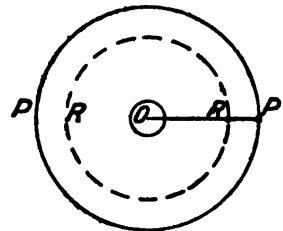

FIG. 32.—ANGULAR VELOCITY

Let *N* = revolutions per minute, and *r* = radius in feet.

Linear velocity = $v = 2\pi Nr$ feet per minute.

Substituting this value in (1) we obtain :—

$$\text{Centrifugal force} = \frac{m(2\pi Nr)^2}{r} = m(2\pi)^2 N^2 r \dots (4)$$

Force is usually measured in terms of *weight* *W*, instead of *mass* *m*, by substituting the gravitation-unit $\frac{W}{g}$ for *m*; where *g* = 32.2 feet per second per second, or 115920 feet per minute.

$$\text{Then } \frac{W}{g} (2\pi)^2 = \frac{W}{115920} \times 39.48 = .0003406 W.$$

and from (4) Centrifugal force = $.0003406 WN^2 r \dots (5)$

Or, taking the force of gravity as unity, and the unit of time .1 second,

$$\text{Centrifugal force} = \frac{(2\pi)^2}{g} N^2 r = 1.226 N^2 r \quad \dots (6)$$

Example :—A drum, 30 inches in diameter, rotates at 1200 revolutions per minute. $N = 1200$, and $r = \frac{15}{12}$ feet. \therefore linear velocity $= 2\left(\pi \times 1200 \times \frac{15}{12}\right) = 9425$ feet per minute. Let $W =$ one pound-weight.

By equation (5) $.0003406 \times 1 \times (1200)^2 \times \frac{15}{12} = 613$ pounds of force per pound-weight.

$$\text{,, ,, (6) } 1.226 \times \left(\frac{1200}{60}\right)^2 \times \frac{15}{12} = 613 \text{ times force of gravity.}$$

In Fig. 32, two bodies, P and R, revolve round the centre o , at the same number of revolutions per minute, or same *angular velocity* ω , then $\omega = \frac{\theta}{t}$ (Fig. 31). From the relation between linear and angular velocities given in equation (2), $v = \omega r$. Substituting this for v in (1) we obtain :—

$$\text{Centrifugal force} = \frac{m(\omega r)^2}{r} = m\omega^2 r \quad \dots (7)$$

But, since $\omega^2 = \frac{v^2}{r^2}$, (7) becomes $\frac{mv^2}{r}$, and is only another form of equation (1).

PRACTICAL APPLICATIONS

Centrifugal force has been applied in the sugar factory for separating solids from liquids by the two following methods.

Method 1.—A non-perforated drum is used, and the difference in density between the solid particles and the liquid causes the two materials to form concentric layers within the rotating drum. Let the space P to R (in Fig. 32) be filled with juice containing a precipitate (due to chemical treatment). The particles of precipitate, being of higher density than the juice, can move radially from R towards P, thus accumulating at the circumference PP, and leaving an inner belt of clear juice near RR.

In this type of machine, centrifugal force acts upon the *solid particles only*, and the force required is inversely proportional to the difference in density between the solid

and the liquid. Some additional force is required to overcome the friction between the solid and the liquid, this depending on the size of the solid particles, or their surface-area per unit weight.

This method may therefore be termed "*centrifugal subsidence*," and was described and illustrated in Chapter XVIII, and Fig. 22.

METHOD 2: THE SUGAR CENTRIFUGAL

The separation of sugar crystals from fluid mother-liquor (or molasses) is effected by allowing the latter to escape through a perforated, rotating drum. Let the space P to R (in Fig. 32) be filled with crystallised massecuite. The fluid at PP can immediately escape through the perforations, whilst the fluid at RR can move towards PP and also escape (by filtering through the sugar crystals). The crystals are retained in the space P to R by a wire-gauze liner covering the perforations at PP.

In this type of machine, centrifugal force acts upon the *liquid only*, forcing it through the gauze liner and perforated drum; the crystals having no similar radial motion. The centrifugal force required is independent of the relative densities of the two materials to be separated, and therefore need not be nearly as great as in method 1. The operation may be termed "*centrifugal filtration*," because the gauze liner acts as a filtering medium.

A vertical section of the machine is shown in Fig. 33. The perforated drum, or "basket," is rigidly attached to the vertical spindle, and the latter is suspended from overhead supports by means of a conoidal rubber ring, which permits the spindle and attached drum to oscillate slightly, but resists such motion. The spindle rotates in ball-bearings, enclosed in a stationary *housing*, resting in the conoidal rubber ring. This arrangement allows the rotating basket to vary its centre of rotation, should the load of massecuite not be perfectly distributed, or "balanced." Any lack of balance would cause excessive friction in a machine with rigid bearings, and, consequently, require more driving power.

In the machine shown in Fig. 33, rotary motion is due to jets of water acting on a pelton-wheel attached to the upper

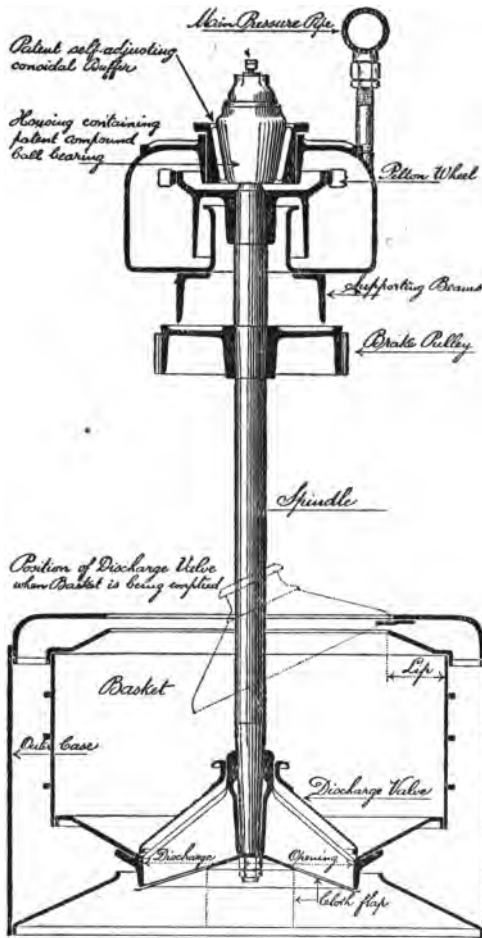

FIG. 33.—VERTICAL SECTION OF SUGAR-CENTRIFUGAL¹

extremity of the spindle, a double-acting pump giving the necessary water-pressure at the jets. The machine is brought

¹ Block lent by Messrs. Watson, Laidlaw & Co., Glasgow.

to rest by shutting off the water-jets, and bringing the brake-pulley into action.

The basket is lined internally as follows:—(1) iron-wire gauze of large mesh, placed in contact with the perforated basket; (2) brass-wire gauze of medium mesh, placed in contact with (1); and (3) fine twilled, or spiral-woven copper gauze, having apertures of about 1 millimetre width, placed in contact with (2). The coarse liners (1) and (2) serve to separate the fine liner (3) from direct contact with the perforated surface of the basket, and thus ensure a free outlet for the molasses. The texture of liner (3) can be varied according to the size of crystals to be treated.

The basket rotates within a stationary outer casing, and the basket and casing have corresponding openings at top for introducing the massecuite, also central openings at bottom for discharging the *cured* sugar crystals. The molasses, escaping from the basket, is caught in the outer casing and flows from a spout at bottom (not shown in Fig. 33).

The discharge-opening at bottom of basket is covered by a brass bell (*discharge-valve*), which allows the basket to be charged with massecuite before being set in motion (see later). After the operation is completed, the valve is raised (as shown in dotted lines), and the sugar crystals discharged.

The working capacity is represented by the cubical contents underneath the "lip," or upper flange of the basket, and varies with the diameter, as follows:—

<i>Diameter of Basket.</i>	<i>Working Capacity in Cubic Feet.</i>
30"	4.2
42"	8.66
48"	10.83
60"	16.50

As much power is consumed each time the basket and its load is set in motion, machines of large diameter consume less power and also require less manual labour to operate them, per ton of sugar treated.

Arrangement of Centrifugal Plant

Twenty or more machines, arranged in line, are "fed" with massecuite from a single vessel, extending horizontally above the line of machines and fitted with gate-valves over each. This distributing vessel has various names:— (1) *feeding-trough*, (2) *strike-mixer*, (3) *massecuite receiver*, and (4) *pug-mill*. The first name is applied to a closed, cylindrical vessel, which is continuously fed with massecuite, and merely distributes this to the numerous machines. The second and third names are applied to large vessels, of V-cross-section, capable of receiving the entire contents of a vacuum pan, and gradually distributing this to the numerous centrifugals. Forms (1) to (3) are fitted with slowly rotating shafts, carrying stirrers, to keep the massecuite in constant motion and to assist in distributing it to the centrifugals.

The fourth name, *pug-mill*, is applied to a special machine for crushing hard lumps of massecuite when the latter has been previously cooled at rest, in tanks. Without such special treatment, the lumps of massecuite would throw the centrifugal baskets out of balance, and it would also be impossible to separate the molasses from these lumps.

The molasses escapes from each machine into a gutter extending the entire length of the plant, and leading the molasses to a suitable receiver, whence it is pumped either to the vacuum pans, or to storage tanks.

The cured sugar, discharged from each machine, usually falls upon a continuous travelling-band (or other type of transporter) moving horizontally below the line of machines. Sometimes, the centrifugals are on the first-floor of the factory and the cured sugar gravitates from the machines through chutes to the bags and weighing-machine on the ground-floor. When the centrifugals are on the ground-floor, the cured sugar is first carried horizontally by the above-mentioned transporter, and then elevated to a *sugar bunk* by means of a *bucket-elevator*. From the *sugar bunk* it gravitates through chutes to the bags and weighing-machine.

Motive Power

The water-driven machine (Fig. 33) has the advantage that the power used is directly proportional to the work done by each machine. Thus, two water-jets act on the pelton-wheel until the basket attains full speed, one jet being then shut off automatically. When treating low-grade massecuites the speed should be accelerated gradually, and this can be effected by starting the machine with only one jet in action.

The same type of *suspended centrifugal* is also driven by belt and pulley, or by electric motor. Illustrations of these will be found in Deerr's *Cane Sugar* (pp. 371-8).

Types of Sugar Centrifugals

(1) *The "Suspended" Type* (Fig. 33), described above, was invented by Bessemer in 1850, and was developed by Weston in 1867. It became the standard type in the cane-sugar industry, and is gradually being adopted in the European beet-sugar industry, where the following types (2) and (3) are more general.

(2) *The Friction-cone Type, or Top-drive.*—The vertical basket-spindle rotates in rigid bearings (above and below the basket). A second and horizontal spindle is driven by a belt and pulley from an adjacent line-shafting. The rotary motion is transmitted from this horizontal (driving spindle) to the vertical (or basket spindle) by means of friction cones (one on each spindle). These cones are pressed into contact by means of a spring acting on the horizontal spindle, but, when the machine is to be stopped, the friction cones are separated by means of a screw acting in opposition to the spring.

(3) *Under-driven Type.*—The basket is attached to the top of a vertical spindle which projects below the basket, and is supported in a *footstep bearing*. A second bearing is placed immediately below the basket, but is capable of slight lateral motion, controlled by rubber buffers, thus allowing the spindle and basket to oscillate slightly (as in the *suspended type*). The spindle is rotated by means of a belt and pulley at its lower extremity.

Types (2) and (3) are usually discharged by lifting the sugar out of the open top of the basket by means of scoops or shovels, necessitating heavy manual labour. More recent machines of the same types have been fitted with bottom discharge-openings at one side of the spindle, but not so conveniently arranged as in the *suspended type* described above.

(4) *Self-discharging Type*.—This is a modification of type (1). The discharge-valve is dispensed with, and the bottom of the basket is more sloping than in Fig. 33. The cured sugar therefore drops through the discharge-opening as soon as rotation ceases.

(5) *Continuous Machines*.—All the centrifugals described above operate intermittently, and must be stopped after each charge of massecuite has been cured, in order to discharge the sugar. This involves the consumption of much power each time the machine is re-started, also a loss of energy when stopping the machine by applying the brake. Attempts have therefore been made to design a centrifugal basket which will discharge the cured crystals, as well as the molasses, when running at full speed. In one form of continuous machine, the basket expands upwards like a funnel, the centrifugal force causing the sugar crystals to rise up the sloping sides of the basket and to escape at the upper edge. Here, the crystals are caught in a stationary, circular trough, whence they are removed by a screw-conveyor. During this upward motion of the crystals, the molasses passes through the sloping wire-gauze liner, and is caught in an exterior, stationary casing.

The objection to this type of centrifugal is the grinding of the crystals against each other during their upward motion in the basket, the sharp edges and angles of the crystals being worn away, giving the finished product a dull appearance.

Mode of Operating

(1) *Charging*.—In order that the crystals may be uniformly cured, it is essential that the cylindrical wall or belt of sugar should be of uniform thickness from top to bottom of the

basket, and this condition is secured as follows. A coarse-grained massecuite is fed into the machine after the latter is in motion, the full charge being added, and full speed being attained in about 1 minute. When the crystals are of medium size, the machine is also charged in motion, but the period of acceleration may be from $1\frac{1}{2}$ to 2 minutes. When treating small-grained, impure massecuite, the acceleration should be much slower, otherwise the crystals next to the copper liner pack closely together, forming a non-porous layer through which the molasses cannot pass. In extreme cases, it is necessary to charge the machine before setting it in motion, and to accelerate very slowly.

It is customary to employ one set of machines exclusively for first sugar (usually of large grain), and a second set for molasses sugars (usually of small grain), each set being fitted with liners to suit the size of the crystals to be cured.

(2) *Spinning*.—Complete separation of molasses from the crystals is opposed by the force of cohesion between the solid and the liquid, so that a film of molasses remains adhering to the crystal surfaces after the bulk of molasses has separated. This film imparts colour, flavour, and odour to the crystals, and also lowers the purity. When the crystals are of moderate and uniform size, the percentage of adhering molasses depends on:—

- (a) The centrifugal force applied, corresponding to the speed of the machine and the duration of spinning.
- (b) The surface-area of the crystals per unit weight of cured sugar.
- (c) The viscosity of the molasses, due to dissolved impurities.

But, when the crystals are small and irregular in size, the percentage of adhering molasses is greatly increased by the following additional factors:—

- (a) High viscosity of the molasses, due to the presence of false grain.
- (e) Incomplete separation of the molasses, due to the "packing" of the sugar against the liner.

In order to remove the adhering molasses, and thus increase the market-value of the crystals, the centrifugal treatment is supplemented by the following operations when producing white granulated sugar.

(3) *Washing or "Purging."*—Water is sprayed over the sugar as soon as the molasses has separated, and whilst the machine is running at full speed. This is effected by means of a spraying nozzle, with flexible pipe-connection to a water-main. It is important that the water used should be clean. The nozzle is moved so as to distribute the water vertically, whilst the rotary motion of the sugar in the machine ensures uniform distribution horizontally. But, owing to the thickness of the belt of sugar, the layers nearest the spindle are more thoroughly washed than the layers next to the copper liner, and this simple treatment is not very satisfactory.

The added water is intended merely to dilute the adhering film of molasses, and thus permit its removal by centrifugal force, but, as it is impossible to prevent sugar being dissolved from the surfaces of the crystals, the escaping washings have a much higher purity than the previously separated molasses. The two liquids should therefore be discharged from the centrifugal into separate gutters, and are distinguished by the following names:—

The true molasses is termed *first-runnings*, *green-molasses*, and *égout-pauvre*. The subsequent washings are termed *second-runnings*, and *égout-riche*. Various mechanical devices for separating the first and second runnings are described and illustrated in Ware's *Beet Sugar Manufacture and Refining*, Vol. II, part vii, chapter 1.

In order to avoid dissolving sugar from the crystals, a saturated syrup is sometimes used instead of water, caught in a separate gutter, and used repeatedly until it becomes too dark in colour to be effective. It is then sent to the vacuum pan, and boiled along with the first-runnings (molasses).

(4) *Steaming* is adopted for the following purposes:—
(a) Heating the mother-liquor (molasses) to render it less viscid, and more easily separated. (b) Washing the crystals by condensation of the steam in contact with them. (c) Drying

the crystals, after they have been washed with water or syrup. (d) To prevent the perforations in the liners and basket from becoming obstructed with false-grain.

For the first three purposes, the steam enters the rotating basket by means of a hinged steam-pipe projecting through a temporary cover on top of the casing. This cover consists of two hinged metal flaps, meeting close to the spindle, and thus preventing the escape of steam from the basket. By varying the pressure and dryness of the steam, the amount of condensation can be controlled to produce either a washing effect, or merely a heating effect. For the purpose (d), the steam enters through the side of the outer casing by two or more jets arranged vertically, the steam acting upon the exterior of the rotating basket. Both methods of steaming may be employed simultaneously when treating low-grade massecuites.

If it be desired to render the molasses less viscid, without condensation of the steam and loss of sugar by solution, the steam may be superheated, or may be replaced by hot air.

(5) *Blueing*.—As washing and steaming frequently fail to remove the last traces of molasses, the sugar, intended to be white, may have a faint yellow tint. This can be concealed by adding a very small quantity of Ultramarine blue, after the washings have separated. Ultramarine is insoluble in water, but, when mixed with water, forms a strongly coloured emulsion, and this is strained through flannel to separate any coarse agglomerated particles. The strained emulsion may be sprayed over the sugar in the centrifugal (running at full speed) by means of a syringe fitted with a spraying nozzle, care being taken to distribute the spray from top to bottom of the wall of sugar. The quantity of emulsion added per centrifugal must be found by trial. Some of the emulsion passes through the sugar, and is discharged from the outer casing, but the quantity retained in the sugar should be sufficient to counteract the yellow tint.

A German coal-tar colour, *Indanthrene Z.*, has also been largely used for "*blueing*" sugar, and is applied in the same manner as Ultramarine. In the foregoing method, the blue material is merely distributed *between* the crystals, but in

such a finely divided state that the two tints blend and neutralise each other, producing the effect of whiteness.

Another method is to draw the blue emulsion into the vacuum pan just before the grain is formed. The sucrose then crystallises upon the minute particles of blue, which thus become enclosed in the fully-grown crystals, and a better effect is obtained than when the blue is applied to the exterior of the crystals, as in the first method.

(6) *Double-curing*.—Although the above operations of washing, steaming, and blueing are largely used in the manufacture of white sugar ("Plantation White," or "Plantation Refined"), a superior product can be obtained as follows. The massecuite is spun in centrifugals without washing or steaming, and the crystals discharged into a vessel in which they are thoroughly mixed with a washing-syrup by means of mechanical stirrers. This constitutes the washing operation and ensures the uniform dilution of the molasses adhering to the crystals. The mixture of crystals and washing-syrup has the consistency of massecuite, and passes to a second set of centrifugals, where the washing-syrup is separated, followed by steaming. The washing-syrup then returns to the washing vessel or "mixer," and is used for treating fresh portions of sugar discharged from the first set of centrifugals. The "*steamings*" are collected in a separate gutter, and replace the original washing-syrup when the latter becomes too dark in colour to be effective, this being then re-boiled in the vacuum pan to recover the contained sugar. The centrifugals used in the *first operation* for separating the molasses are termed the "*fore-workers*," and those used in the *second operation* for separating the washing-syrup are termed the "*after-workers*."

A convenient arrangement for double-curing consists in placing the "*fore-workers*" on the first-floor, the sugar crystals gravitating from the vacuum pan to the "*fore-workers*," from the latter to the washer or mixer, and from the mixer to the "*after-workers*" on the ground-floor. The washer takes the place of the *feeding trough* attached to the "*after-workers*," and the separated washings are pumped back to this washer.

When both sets of centrifugals are on the same floor, the sugar discharged from the "*fore-workers*" falls upon a horizontal transporter and is conveyed to a bucket-elevator, which drops it into the washer, whence it gravitates to the "*after-workers*." Manual labour is economised by employing one or two *self-discharging* centrifugals, of large diameter, as "*fore-workers*."

The mode of operating the centrifugals necessarily depends on the kind of sugar to be made.

(1) *Raw Sugar for refining*.—In this case, colour and appearance are of minor importance, and the purity need not exceed 96 Polarisation.

A coarse-grained massecuite is sufficiently *cured* after spinning for two minutes. A small-grained massecuite will also *cure* easily, if the crystals are of uniform size. But, as the size of crystal decreases, the cured sugar retains a larger percentage of molasses, and consequently, has a lower polarisation and purity.

In treating low-grade massecuite, the following precautions may be necessary :—

- (a) *Steaming*, to reduce the viscosity of the molasses during spinning.
- (b) *Dilution* with hot diluted molasses, or with hot water added in the *feed-mixer*. This is of especial value when the massecuite is highly concentrated, but may also be adopted in order to dissolve part of the false-grain.
- (c) *Washing* is only resorted to when the above methods fail. If the *first-runnings* (molasses) are to be re-boiled, the washings can pass into the same gutter, and any sugar dissolved by the wash-water will be subsequently recovered. But, if the massecuite treated should yield exhausted-molasses, the washings (or steamings) must be collected in a separate gutter, so that they may be returned to the vacuum pan.

(2) *Yellow Crystals* (or "*Demerara Sugar*").—This quality is cured without washing or steaming, its attractive colour and pleasant flavour being due to the adhering film of

molasses. It is frequently imitated by dyeing white sugar (made from cane or beet) with aniline dyes added in the centrifugal, in the manner described under "*blueing*."

(3) *White Sugars*.—In this case washing is an essential part of the centrifugal treatment, and special arrangements must be provided for collecting the washings and steamings separately from the molasses, or *first-runnings*. Single-curing, followed by washing and steaming, yields a clean sugar of about 99·8% Purity when dry, and quite suitable for domestic purposes. But, in order to compete with refined granulated sugar, the last trace of colour must be removed by the more thorough operation of *double-curing*, described above.

DRYING THE CURED SUGAR

This final operation is mainly employed in the case of white sugar, but occasionally also for raw sugar. The following methods are used.

(1) *Steaming in the Centrifugals*.—By employing *dry steam* in the centrifugals, the crystals are thoroughly heated, and become quite dry on exposure to the air for a short period, or by passing the sugar through a coarse rotary sieve driven by belting. This operation also separates any lumps, which can be crushed before the sugar is bagged off.

(2) *Hot-air Driers*.—These are large iron cylinders, slightly inclined from the horizontal, and rotating slowly on a central axis. The interior of the cylinder is fitted with numerous shelves so that the sugar is first lifted and then dropped when the cylinder and shelves rotate. The moist sugar enters at the elevated extremity and passes to the opposite extremity of the cylinder in 5 to 7 minutes, whilst a current of hot air is drawn through the cylinder in the opposite direction by means of an exhaust-fan. The hot air enters the drier at a temperature of about 120° C. (248° F.), and leaves at a temperature of about 50° C. (122° F.), containing about 40 grams of water-vapour per cubic metre. The temperature of the dried sugar is also about 50° C. When treating white sugar, the moisture percentage can be reduced to about 0·1, and when treating raw sugar, to about 0·5%.

CHAPTER XXVI

COMPLETE CRYSTALLISATION, AND CONTROL TESTS

THE foregoing operations of boiling, crystallisation, and centrifugal separation have now to be combined in order to extract the crystallisable or "*available*" sucrose in the syrup, and original juice.

The starting point is syrup of purity S (derived from juice of same purity), and the removal of crystals from this syrup yields a final product of purity M, incapable of further crystallisation by evaporation of water, and therefore termed exhausted, or final molasses. It is a black, viscid fluid having the following approximate composition:—

	<i>Cane Molasses.</i>	<i>Beet Molasses.</i>
Water	20	20
Sucrose	34	50
Reducing sugars	22	traces
Non-sugars	24	30
	100	100

Various theories have been advanced to explain why the contained sucrose fails to crystallise, and the student is advised to study Chapter V of Geerligs' *Cane Sugar and its Manufacture*. (See definition on p. 324.)

In the cane-sugar factory, the purity (S) of the syrup is about 85, and that of the final molasses (M) is about 45, giving a *fall in purity* of $85 - 45 = 40$ units of True Purity. In the beet-sugar factory, (S) is about 90, and (M) about 63, giving a fall in purity of $90 - 63 = 27$ units of True Purity.

The fall in purity from (S) to (M) cannot be effected in

a single boiling, followed by separation of crystals, because the resulting *massecuite* would be too stiff to discharge from the vacuum pan, and to treat in the centrifugals.

METHOD I: SEPARATE BOILINGS.

This method was described on p. 254, and possesses the following disadvantages:—

(1) High-grade sugar is obtained from the first *massecuite* only, the second, third, and fourth sugars being dark in colour, small-grained, and containing a considerable quantity of molasses. Raw sugar is not washed in the centrifugals, and its market-value is determined by analysis. The quantity of molasses in this sugar is proportional to the surface-area of the crystals per unit weight of sugar, and therefore varies with the size of the crystals.

(2) Owing to the decreasing purities of the various mother-liquors, the time required for complete crystallisation after each boiling is approximately as follows. *First massecuite* (boiled from syrup) requires one or two days; *second massecuite* (boiled from *first molasses*) requires two or three weeks; *third massecuite* (boiled from *second molasses*) requires at least one month, and *fourth massecuite* (boiled from *third molasses*) requires at least six months.

(3) The *massecuites* boiled from molasses are usually “*boiled smooth*,” and allowed to crystallise during cooling in tanks. Hence, very large tank-capacity is required to store the different grades of *massecuite* until they are ready for centrifugal treatment.

(4) Manual labour is necessary in digging the *massecuites* from the cooling-tanks, and considerable loss of sugar results (*a*) from spillings during transport from the tanks to the centrifugals, and (*b*) from addition of water during digging, to lighten the work.

The low-grade sugars obtained above may be converted into high-grade sugar by one or other of the following schemes:—

(*a*) “*Seeding the Pan*.”—Syrup is concentrated in the vacuum pan nearly to graining point, and a quantity of low-grade sugar then added to the boiling syrup, instead

of forming grain directly from the syrup. The added crystals are termed "*seed-grain*," and their growth is effected in the manner previously described (pp. 281–283).

Seed-grain is also frequently added to molasses, which must otherwise be *boiled smooth* and allowed to crystallise during cooling. The added grain excites crystallisation (as explained on p. 278), causing the growth of the seed-grain, and eventually yielding a coarse-grained molasses-sugar.

(*b*) *Mixing Low-grade and First-grade Sugars*.—Syrup is *grained high up* in the pan, producing a small-grained masse-cuite, the crystals being of the same size as those of the low-grade sugar to be added. As this syrup masse-cuite flows from the vacuum pan, the low-grade sugar is gradually added, and the mixture passed into a crystalliser where it is kept in motion for an hour or two, forming a uniform blend, which is cured hot. It then yields a small-grained sugar, mainly derived from syrup, and of equal purity to first-grade from syrup alone.

In this mode of working, the added low-grade sugar is purified as follows:—(*a*) the crystals are washed by the purer mother-liquor derived from syrup, and (*b*) the crystals are cured *a second time*, after being blended with syrup crystals of equal size.

(*c*) *Dissolving and Re-crystallising the Low-grade Sugars*.—The low-grade sugar is dissolved in the juice, and converted into first-grade crystals when the juice is concentrated to syrup, and the latter is boiled and crystallised in the vacuum pan. The impure molasses contained in the low-grade sugar remains in solution in the juice, syrup, and *first molasses* separated from the first-grade crystals. It is not advisable to dissolve the sugar in juice or syrup which has been carefully neutralised and clarified, because the added sugar may be acid, or alkaline, and would render the juice cloudy. The rational plan is to dissolve it in the raw juice (*i. e.* before chemical treatment), but this has the objection that the density of the juice is increased, and the subsidence of the lime-precipitate may be retarded.

To avoid these objections, Geerligs recommends the following practice. The low-grade sugar is dissolved in a sufficient

quantity of hot, raw juice to form a syrup of about 28° Beaumé, which is clarified by liming, heating, and skimming, in a suitable tank, and drawn into the vacuum pan, where the true syrup (concentrated juice) has already been grained. The sugar-syrup drawn in has a purity equal to that of the true syrup, and can therefore replace it, producing first-grade massecuite. The large bulk of juice is treated in the usual manner, without addition of low-grade sugar.

A few remarks may be made on the relative advantages of the above methods of returning low-grade sugars.

Method (a).—When used as *seed-grain* for *syrup massecuite*, the boiling operation is shortened by eliminating the difficult operation of *graining the syrup*; and, in many cases, the total heating-surface of the vacuum-pan can be used from the start.

When used as *seed-grain* for *molasses massecuite*, crystallisation of the molasses begins during boiling in the vacuum pan, and is completed during cooling in much less time than when the same molasses is boiled alone (*boiled smooth*), and allowed to crystallise during cooling.

A part of the added *seed-grain* dissolves in the boiling syrup, or molasses, leaving only the larger crystals to serve as *grain*. The dissolved portion (mostly *false-grain*) is re-crystallised during the following boiling and cooling, and finally obtained as a lower-grade sugar.

Method (b).—The low-grade sugar cannot dissolve in the *syrup massecuite* to which it is added, this being already supersaturated. Hence, the sucrose crystals in the low-grade sugar are converted into first-grade sugar without loss. Although simple and efficient, this method may be objected to on account of the small grain of the first-grade sugar, refiners preferring a large grain.

Method (c) may be substituted for *method (b)* when a coarse-grained first sugar is required, but necessitates additional vacuum-pan capacity, since the low-grade sugar is entirely dissolved, and has to be re-crystallised.

The foregoing schemes may be termed “corrective measures,” to be adopted *after* the low-grade sugars have been manufactured in order to dispose of them. The method

now to be described is based on the proverb:—" *Prevention is better than cure.*"

METHOD 2: MIXED BOILINGS

Principles

The following objects are kept in view:—

- (1) To reduce the number of boilings and crystallisations, so as to obtain only one or two grades of sugar crystals.
- (2) To produce coarse-grained massecuites in each boiling operation, since this facilitates the separation of molasses from the crystals, increasing the purity of the cured sugar.
- (3) To reduce the time required for complete crystallisation.

These objects are attained as follows:—

(1) *Reducing the Number of Boilings.*—The final boiling, followed by cooling, must yield a mixture of crystals + exhausted molasses. Let this mixture have a purity (P), lying between the purity (S) of the syrup and purity (M) of exhausted molasses. Then, the earlier boilings and crystallisations must cause the purity to fall from (S) to (P).

First Boiling.—The difference (S-P) may be reduced during the first boiling by adding to the syrup a material (rich molasses) of purity less than (S), thus producing a *mixed massecuite* of purity between (S) and (P). This yields first-grade sugar, derived from the two constituents (syrup and molasses), but of equal purity and appearance to the crystals derived from syrup when boiled alone. Moreover, the added molasses acts as a diluting-agent, keeping the massecuite fluid, and thus permitting more water to be evaporated from the syrup-constituent than when the syrup is boiled alone, and, consequently, a larger quantity of sugar crystallises from this syrup-constituent during the first boiling.

Last Boiling.—We will assume that the above-mentioned *mixed massecuite* resulting from the first boiling, when spun in the centrifugals, separates into first-grade sugar, and molasses of purity (T). This purity (T) may be less than

the purity (P) of the *final massecuite to be obtained*, but the sucrose dissolved in this molasses cannot crystallise until the molasses has been concentrated. If the molasses be boiled alone it yields a massecuite of equal purity (T), and only crystallises during cooling, yielding very small crystals (low-grade sugar). But, on adding a suitable quantity of purer material (syrup or richer molasses) until the mixture has a purity (P), this mixture can be grained in the vacuum pan and finally yields a superior grade of commercial sugar, and a residue of exhausted, or uncrystallisable molasses.

In both cases the *grain* is formed by boiling a small quantity of the purer material (syrup) alone, this grain growing when the pan is gradually fed with the molasses of low purity (T); the boiling mixture having the desired purity (P) lying between (S) and (M). Crystallisation is completed during *cooling in motion*, the purity of the mother-liquor gradually falling to (M) of exhausted molasses.

We have here assumed that only two boilings are necessary, but the same general principles apply in the case of three boilings.

(2) *Producing Coarse-grained Massecuites at each Boiling.*—As *grain* is formed in the vacuum pan during each boiling, it is obvious that the size of the fully-grown crystals can be controlled by forming more or less grain, by the methods previously described on p. 281.

(3) *Reducing the Time required for Complete Crystallisation.*—Assuming that three boilings are necessary, yielding massecuites 1, 2, and 3, much time can be saved by curing 1 and 2 hot, direct from the pan, because the sugar dissolved in the hot mother-liquors can be recovered in the third massecuite which is *cooled in motion* before being cured. Hot curing has the advantage that the viscosity of the mother-liquor is greatly reduced, thus facilitating centrifugal separation.

Crystallisation of the last massecuite is partially effected during boiling in the vacuum pan, and completed in a few days during *cooling in motion*. Such motion causes intimate contact between the growing crystals and the supersaturated mother-liquor, thus favouring rapid crystallisation.

Practical Applications

The applications of the foregoing principles are illustrated in the attached folding-sheet. Scheme No. 1, for raw cane sugar, is taken from Geerligs' *Cane Sugar, and its Manufacture*, p. 229. Schemes 2 and 3, for white cane sugar, are from the same author's *Practical White Sugar Manufacture*, pp. 106 and 107. Schemes 4 and 5, for white beet sugar, are taken from Pellet and Métillon's *Vade Mecum de Sucrierie*, pp. 89 and 91. The five schemes are here presented in diagrammatic form.

It should be remarked that "*Apparent Purities*" are used in schemes 1 to 3, and "*True Purities*" in schemes 4 and 5. Thus, exhausted cane-molasses is shown with 30 *Apparent Purity* in schemes 1 to 3, but would mean 40 to 45 *True Purity*. The beet-molasses is shown with 60 *True Purity*, but would correspond to from 57 to 58 *Apparent Purity*.

A summary of the five schemes is given below.

	Schemes.	Sugar.		Number of		
		Quality.	Grades.	Boilings.	Crystallisations during Cooling.	Curings.
Cane	1	Raw	1	3	1	3
	2	White	2	3	{ 1 in motion 1 at rest }	5
	3	"	1	3	1	4
Beet	4	"	2	2	2	2
	5	"	1	2	2	{ 1 curing 2 filtrations }

The first four schemes can be modified in different factories to suit local conditions. Scheme No. 5 introduces a novel feature, namely, the crystallisation of molasses *by cooling* without further evaporation of water. As such crystals are too minute to separate in centrifugals, filtration through cloth is substituted. The method is designed to reduce the weight of massecuites to the smallest possible percentage of the beets treated, thus reducing the total vacuum-pan capacity per 100 tons of beets, and obtaining exhausted molasses in the shortest possible time.

BEET-SUGAR FACTORY

METHODS USED

Scheme 1.—Java

or White Sugar (two grades)

Group of 90 Purity grained alone, and grain built up by addition of Molasses (A) and centrifugal washings (B) to produce Massecurite No. 1, of 83 Purity and 94 Briz cooled slowly in motion.

High-grade Raw Sugar.

First Molasses (A) of 68 Purity.

Centrifugal washings (B) of 75 Purity.

Part of this is used as above. All is used as above.

Remainder is boiled with seed-grain (C) to form Massecurite No. 2, of 8 Purity slowly cooled in motion.

High-grade Raw Sugar.

Exhausted Molasses of 60 True Purity.

High-grade Raw Sugar.

or White Sugar (one grade)

Scheme 2.—Java

Delfosse)

Group of 90 Purity is grained alone, and grain built up with Molasses of 80-85 Purity, forming Massecurite No. 1, of 91 Purity, with small grain.

Impure White Sugar. Mixed with purging Syrup (A) and cured a second time. Washed, bleached, and steamed in centrifugals.

First Molasses, of 81 Purity.

Part A.

Part B.

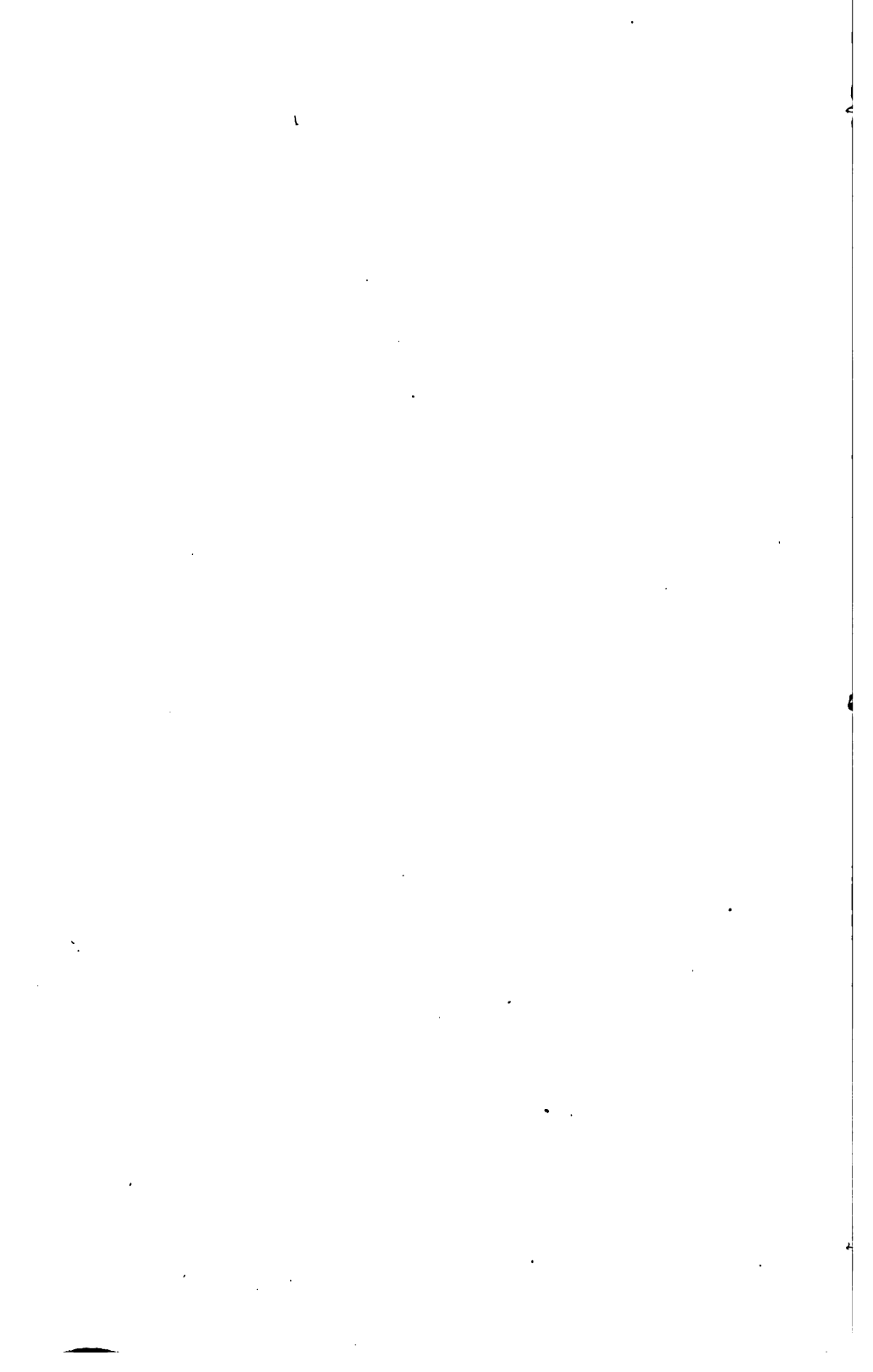

CONTROL TESTS

(1) *Control of Supersaturation in the Vacuum Pan.*—Although the experienced pan-boiler can obtain excellent results by the use of his eyes and fingers alone, more scientific methods of control are desirable. The following method is based on the fact that the boiling point of syrup (at any given pressure, or vacuum) is directly proportional to the concentration or *Brix* of the syrup (see under “*boiling point*” on p. 243).

This principle is adopted in the “*Brasmoscope*” or “*Brixometer*,” invented by Curin, and comprising the following attachments to the vacuum pan:—

- (1) A thermometer projecting into the centre of the pan, and indicating the boiling point of the contained syrup.
- (2) A mercury syphon-barometer, the open limb of which is connected to the interior of the dome of the pan, and which measures the vacuum corresponding to the boiling point of the syrup.
- (3) Three graduated scales, resembling a slide-rule, but placed vertically against the exterior wall of the vacuum pan, adjacent to the barometer and thermometer scales. The barometer and scales are shown in Fig. 34.

The central scale D is graduated in degrees Brix, and slides between the two fixed scales V (for vacua) and T (for temperatures). The mode of operating is as follows.

Let the barometer show 28 inches of vacuum (=2 inches pressure), and the thermometer show 140° F: as the boiling point of the syrup. Scale D is moved (up or down) until the zero of this scale coincides with the observed vacuum on scale V. A sliding pointer on scale T is adjusted exactly to the observed boiling point on this scale, and an extension of this pointer gives the Brix of the boiling syrup on scale D.

The various temperatures on scale T represent the boiling points of pure water at the corresponding vacua on the

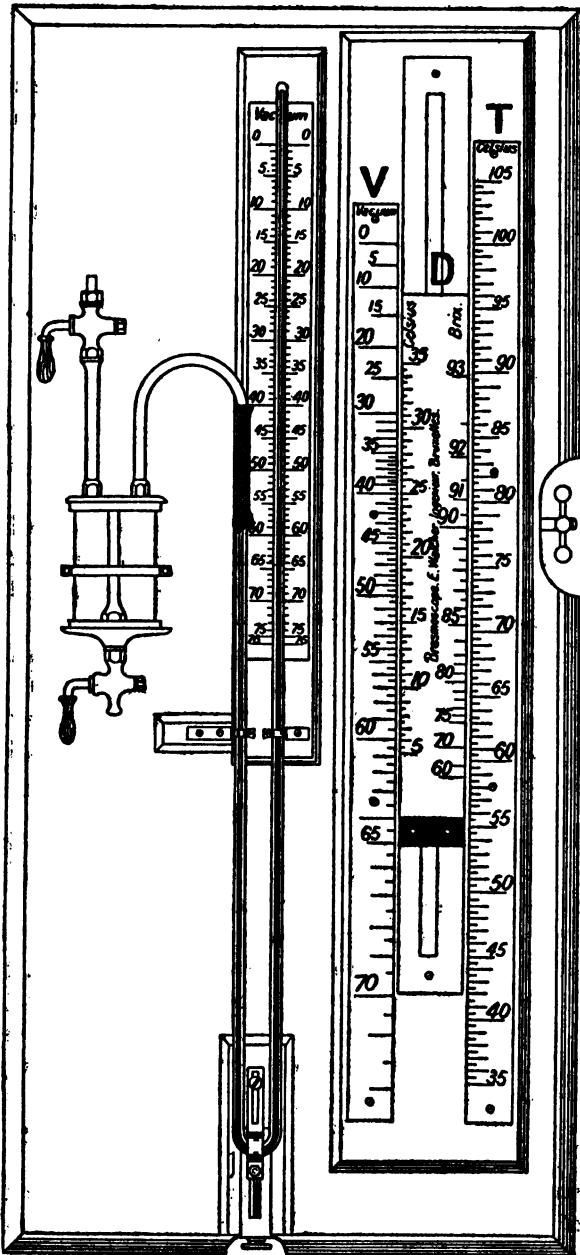

FIG. 34.—BRASMOSCOPE OR BRIXOMETER

opposite scale V. Thus, with a vacuum of 28 inches, pure water boils at 100° F. Under the same pressure, we have assumed that the syrup boils at 140° F., or a difference of 40° F. due to the dissolved solid matters. If the syrup contained only pure sucrose and water, this elevation of boiling point would be equivalent to 89.8% of dissolved sucrose. As syrup also contains non-sugars, the value 89.8 is the *Brix*, or *apparent dry solid matters* in the syrup (see p. 145); and the water-content of the syrup will be $100 - 89.8 = 10.2\%$.

Now, the Brix of a *saturated sucrose solution*, at the same temperature. (140° F.), is 74.2 (from published Tables of Solubility); consequently the *Coefficient of Supersaturation* (p. 277) of the boiling syrup = $\frac{89.8}{74.2} = 1.21$.

The pan-boiler can thus determine this coefficient at any moment during the boiling, by observing the vacuum and boiling point, and adjusting scale D, and pointer on scale T, accordingly.

When crystals have been formed, and during their growth, they exert no influence on the boiling point, since this is only influenced by *dissolved solid matter* in the fluid mother liquor surrounding the crystals. Consequently, the *Brasmoscope* still indicates the Brix of the boiling fluid or mother-liquor, and thus permits the degree of supersaturation to be regulated during the gradual growth of the crystals (see p. 278).

When the crystallised massecuite becomes semifluid, and ceases to circulate freely, its mean temperature is no longer accurately indicated by the thermometer, and the *Brasmoscope* indications become unreliable. But, during this final stage of boiling the crystals are fully grown, and the final concentration of the massecuite can be judged with sufficient accuracy by the simple test described on p. 284.

The *Refractometer* (p. 145) has also been employed for rapidly measuring the Brix of the syrup during boiling in the vacuum pan. But when the syrup contains crystals, this test becomes too delicate, and occupies too much time, to be of much assistance to the pan-boiler.

(2) *General Calculations relating to Massecuities.*

	Brix.	Density.	Purity.	Sucrose %.
Let syrup =	B	D	P	S
„ massecuite =	B ₁	D ₁	P ₁	S ₁
„ molasses } separated =	B ₂	D ₂	P ₂	S ₂
„ raw sugar } from } massecuite =	B ₃	D ₃	P ₃	S ₃

- (1) Weight of massecuite obtained from 100 parts by weight of syrup $\left. \vphantom{\begin{matrix} (1) \\ (2) \end{matrix}} \right\} = \frac{100 B}{B_1}$
- (2) Volume of massecuite obtained from 100 volumes of syrup $\left. \vphantom{\begin{matrix} (1) \\ (2) \end{matrix}} \right\} = \frac{100 BD}{B_1 D_1}$
- (3) Volume of molasses in 100 volumes of massecuite $= \frac{100 D_2 (100 - B_1)}{D_2 100 - B_2}$
- (4) Percentage by weight of molasses in massecuite $= \frac{100(100 - B_1)}{100 - B_2}$ or $\frac{100(100 - S_1)}{100 - S_2}$
- (5) „ „ „ „ crystallised sucrose in massecuite $\left. \vphantom{\begin{matrix} (5) \\ (6) \end{matrix}} \right\} = 100 - \text{molasses \%}$
- (6) Weight of crystallised sucrose in 100 volumes massecuite $= \frac{100 B_2 D_2 (P_1 - P_2)}{100 - P_2}$
- (7) Percentage by weight of raw sugar obtained from massecuite $\left. \vphantom{\begin{matrix} (6) \\ (7) \end{matrix}} \right\} = \frac{100 B_2 (P_1 - P_2)}{B_2 (P_2 - P_3)}$

Note.—(1) and (2) apply to massecuites boiled from syrup alone.

(3) to (7) apply to mixed massecuites, as also to syrup massecuites.

(5) and (6) refer to pure sucrose in the form of crystals.

(7) refers to commercial sugar separated by centrifugals, without purging.

(3) Control of Purities of Mixed Massecuites.

A mixed massecuite, of Purity P_1 , is to be boiled from a mixture of syrup (Purity P) and molasses (Purity P_2).

Method (a) :—

$$\begin{aligned} \text{Syrup + molasses} &= \text{mixture entering pan} \\ \text{Volumes} &= 100 + x = (100 + x) \\ \text{Purities} &= \frac{P}{P_2} = \frac{P_1}{P_1} \end{aligned}$$

Then $P_2 x = P_1(100 + x) - 100P$

$$\therefore x = \frac{100(P - P_1)}{P_1 - P_2} = \text{volume of molasses per 100 volumes of syrup.}$$

Method (b) :—

$$\begin{aligned} \text{Syrup + molasses} &= \text{mixture entering pan} \\ \text{Volumes} &= x + (100 - x) = 100 \\ \text{Purities} &= \frac{P}{P_2} = \frac{P_1}{P_1} \end{aligned}$$

Then $Px + P_2(100 - x) = 100P_1$

$$\therefore x = \frac{100(P_1 - P_2)}{P - P_2} = \text{volume of syrup.}$$

$100 - x =$ „ „ molasses.

100 volumes of syrup are to be mixed with x volumes of molasses (A) and y volumes of molasses (B) to form a mixed massecuite of Purity P_1 .

	Syrup + molasses A + molasses B =				mixture entering pan	=	massecuite obtained after boiling
Volumes	100	+	x	+	y	=	$(100 + x + y) = T =$
Purities	P		P_A		P_B		P_1
Brix	B		B_A		B_B		B_C
Density	D		D_A		D_B		D_C

The volume (C) = known capacity of vacuum pan, and can be converted into the volume of fluids $(100 + x + y)$ entering the pan, thus:—

$$\frac{C(B_C D_C)}{BD} = T \text{ at density D of syrup.}$$

Then, if molasses (A) and (B) are also of density D:—

$$\text{volume } x = \frac{T(P_1 - P_B) - 100(P - P_B)}{P_A - P_B}$$

$$\text{volume } y = T - 100 - x.$$

But, the three materials have densities:—D, D_A , and D_B respectively, and the following correction is required:—

$$\left. \begin{aligned} \text{true volume of } x &= \frac{xBD}{B_A D_A} \\ \text{true volume of } y &= \frac{yBD}{B_B D_B} \end{aligned} \right\} \text{per 100 volumes of syrup.}$$

Note.—Usually one of the two molasses (say A) is entirely returned to the vacuum pan, but only a portion of the other. In this case, the volume $(100 + x)$ is known and its Purity is easily calculated. It may then be regarded as a single material to be mixed with molasses B in such proportion as will yield a mixture of Purity P_1 (see above).

Example

Syrup	= B = 55	D = 1.261	P = 93.0
Molasses A	= B_A = 60	D_A = 1.290	P_A = 77.0
Molasses B	= B_B = 57	D_B = 1.272	P_B = 68.0

100 volumes of syrup are to be mixed with x volumes of molasses (A) and y volumes of molasses (B) in order to yield 1000 volumes of mixed fluids of Purity 75

entering vacuum pan. Assuming the three fluids to be of equal density, we obtain :—

$$x = \frac{1000(75 - 68) - 100(93 - 68)}{77 - 68} = 500$$

$$y = 1000 - 100 - 500 = 400$$

$$\text{Syrup} = 100$$

1000 = mixture (T) entering
vacuum pan.

Corrections for actual densities of molasses A and B :—

$$x = \frac{500(55 \times 1.261)}{60 \times 1.290} = 448 \text{ volumes of molasses A of Purity } 77.0$$

$$y = \frac{400(55 \times 1.261)}{57 \times 1.272} = 383 \text{ ,, ,, ,, B ,, ,, } 68.0$$

$$\text{100 ,, ,, syrup of Purity } 93.0$$

$$\text{Total} = \underline{931} \text{ ,, ,, mixed fluids of Purity } \underline{75.0}$$

The volumes of the three fluids, to produce 1000 volumes of mixed fluids, can then be calculated. In practical work, these calculations are avoided by the use of Tables, previously constructed from these equations.

CHAPTER XXVII

EFFICIENCY OF CRYSTALLISING OPERATIONS

THE efficiency of the entire factory operations may be considered under two heads, namely:—

(a) Extraction of sucrose in the form of juice, from the cane, or beet. This was dealt with in Chapters VII, XI, and XV.

(b) Extraction of sucrose in the form of crystals, from the juice. Here, the term efficiency may relate to:—

- (1) The quality, or market-value of the crystals; and
- (2) The quantity of crystals obtained per 100 parts of sucrose present in the juice.

(1) QUALITY AND MARKET-VALUE OF THE CRYSTALS

White and yellow sugars are valued by appearance rather than by analysis; absence of colour being required in the former, and a certain shade of yellow in the latter; whilst both should consist of well-formed crystals of uniform size. These qualities cannot be measured quantitatively, but the factory products can be compared with standard samples kept for this purpose.

The value of raw sugar is fixed by analysis, which indicates the probable yield of refined white sugar obtainable from it; colour, and size of crystals are of secondary importance.

The keeping qualities of sugars during transport and storage also materially influence the market-value. White sugar may become tinted if insufficiently purged during curing, or insufficiently dried, and cooled, before being bagged. Deterioration is much more marked in the case of raw sugar, being due to inversion of sucrose by bacteria and other

organisms, causing a decrease in polarisation, and therefore a reduced market-value. This bacterial deterioration can only occur in moist sugars, and, it being impossible to sterilise the sugar itself, the practical remedy is to render the sugar sufficiently dry to prevent bacterial activity. When excessive moisture is due to incomplete curing of the sugar, the remedy is obvious; and experience indicates that not more than 1.0% of moisture should be present when the raw sugar is bagged.

But moisture may be absorbed from the atmosphere during transport and storage; and, in extreme cases, the sugar "sweats," becoming quite wet, and a syrupy fluid drains from the bags. In less serious cases, deterioration is proved by a fall in polarisation and increase in moisture % during transit from the factory to the buyer. It is therefore desirable to analyse an average sample of each shipment leaving the factory, and to compare the results with the "buyer's analysis" at a later date.

The fall in polarisation may mean a considerable financial loss; but, as already stated, inversion of sucrose by bacteria can only occur in the presence of excessive moisture. Absorption of moisture from the atmosphere may be traced to one or other of the following hygroscopic substances in the molasses adhering to the crystals:—Calcium acetate (derived from acetic acid present in juice from diseased, or stale canes); chlorides, derived from saline soils; decomposition products of reducing sugars. It may also be due to excessive concentration of the final massecuite, which renders the contained mother-liquor hygroscopic. Most of these causes may be eliminated by careful control of the factory work.

(2) QUANTITY OF CRYSTALS OBTAINED

As commercial sugars contain variable percentages of actual *sucrose*, the factory-yield of raw sugar should be calculated to *tons of sucrose*, thus:—

$$\text{Tons of sucrose in raw sugar} = \frac{\text{Tons raw sugar} \times \text{Polarisation}}{100}$$

This calculation is applied to each grade of sugar separately,

giving the total yield of *sucrose* in the sugars made. This yield may then be expressed in three ways:—

$$\begin{aligned}
 (a) \text{ Sucrose recovered per 100 of canes } & \left. \begin{array}{l} \text{(or beets) entering factory} \\ \text{in canes (or beets)} \end{array} \right\} = \frac{\text{Tons sucrose recovered} \times 100}{\text{Tons canes (or beets)}} \\
 (b) \text{ Sucrose recovered per 100 of sucrose } & \left. \begin{array}{l} \text{in canes (or beets)} \\ \text{in extracted juice} \end{array} \right\} = \frac{\text{Tons sucrose recovered} \times 100}{\text{Tons sucrose in canes (or beets)}} \\
 (c) \text{ Sucrose recovered per 100 of sucrose } & \left. \begin{array}{l} \text{in canes (or beets)} \\ \text{in extracted juice} \end{array} \right\} = \frac{\text{Tons sucrose recovered} \times 100}{\text{Tons sucrose in juice}}
 \end{aligned}$$

The following examples are taken from practice:—

	(a)	(b)	(c)	
	Per cent. on Canes.	Per cent. on Sucrose in Canes.	Per Cent. on Sucrose in Juice.	
Mill Work {	Sucrose in extracted juice	= 12.80	= 92.8	= 100.0
	„ lost in bagasse	= 0.99	= 7.2	
	„ in canes crushed	= 13.79	= 100.0	
Crystallisation {	Sucrose recovered in first sugar	= 8.37	= 60.72	= 65.44
	„ „ second sugar	= 1.80	= 13.04	= 14.05
	„ „ third „	= 1.01	= 7.34	= 7.91
	„ „ total sugars	= 11.18	= 81.10	= 87.40
	Sucrose lost {	= 1.62	= 11.70	= 12.60
	in filter-press cake			
	by inversion			
„ „ entrainment				
in final molasses				
Total Sucrose in juice	= 12.80	= 92.80	= 100.0	

The *sucrose lost in filter-press cake*, also the *sucrose lost by inversion*, occur before crystallisation begins; yet, in the foregoing record, these losses reduce the yield of *sucrose recovered as total sugars*.

The *sucrose lost by entrainment* occurs, partly during concentration of the juice to syrup in the multiple-effect evaporator, and partly during boiling and crystallisation in the vacuum pan. In either case, the loss is exceedingly small because evaporators and pans are equipped with “*separators*” or “*save-alls*.” Any bubbles of juice (or syrup), suspended in the *juice-steam*, are deposited upon the sides of the *save-all*, and flow back into the evaporator.

The *sucrose lost in the final molasses* greatly exceeds the above-mentioned losses, and must be considered in some detail.

Sucrose in Final Molasses

It is important to distinguish between the *final molasses* produced in a factory, and the fully *exhausted molasses* which is theoretically possible. The following definitions will make this distinction clear.

(1) *Exhausted Molasses* is the *fluid by-product* resulting from the complete extraction of crystallisable sucrose from the juice (or syrup) by evaporation of water, followed by cooling. It is therefore the mother-liquor from which crystals have been separated, and should be free from suspended crystals (large or small). It still contains a large percentage of dissolved sucrose, which appears to be "fixed" by the mineral matters also present.

Geerligs explains this *fixation* of sucrose by the following definition:—"Molasses is a hydrated combination of sucrose and mineral matters, which cannot be dissociated in a concentrated state, and therefore cannot yield sucrose in a crystallised form." He states that in well-exhausted Java molasses the ratio of *water : sucrose* varies between 1:1.3 and 1:1.6; the ratio of 100 *dry solids : sucrose*, or *True Purity* being about 35 (equal to about 30 *Apparent Purity*). His investigations point to the conclusion that the percentage of sucrose is mainly determined by the ratio of *mineral matters : reducing sugars* in the original juice. When this ratio exceeds 1:1.5, the exhausted molasses should have a True Purity of 35 to 40; but when the ratio falls below 1.5, the True Purity of the exhausted molasses increases. In rare cases, cane juice may give the ratio 1:0.5, in which case the exhausted molasses may have a True Purity of 60, closely resembling exhausted beet-molasses. The quantity of molasses produced per 100 of canes crushed, or per 100 of commercial sugar made, is directly proportional to the percentage of mineral matters in the juice.

(2) *Factory final-molasses* may differ from the above as follows:—

- (a) It frequently contains a small quantity of sucrose capable of crystallising by further evaporation of water, followed by cooling. This indicates in-

sufficient concentration of the *final massecuite* in the vacuum pan.

- (b) It may be excessively viscid and hygroscopic, due to over-concentration of the *final massecuite* (the reverse of (a)).
- (3) It frequently contains minute sucrose-crystals in suspension, due to the following causes:—
- (a) *False-grain* in the *final massecuite*, which passes through the centrifugal-liners. This indicates defective crystallisation either in the vacuum pan, or in the crystallisers.
- (b) *Crystallisation of the final-molasses* after it leaves the centrifugals. This indicates that the *final massecuite* was cured too soon, or at too high a temperature.

Such crystals may only be detected by means of the microscope, and cannot be separated from the molasses by filtration. On analysing the molasses, the crystals are included in the percentage of sucrose found, thus raising the purity of the sample. It has generally been assumed that the percentage of crystals is too insignificant to influence the analytical figures, but this view has been recently disproved by Kalshoven (in Java), who has devised a simple optical method of determining the percentage of crystals. On examining 80 samples of final-molasses obtained in modern Java factories, he obtained the following results:—

Cane-molasses

5	samples	were quite free from crystals
2	"	contained less than 1·0%
47	"	" from 1·0% to 10·0%
25	"	" " 11·0% to 16·0%
1	sample	contained 17·7%

Average of 80 samples = 8·0%

The seriousness of this loss has been indicated by Harloff as follows. The Java crop of 16 million tons of cane produces 444,800 tons of final-molasses. If 8·0% of this consists of sucrose crystals, it means a loss of 35,000 tons of crystallised

sucrose in Java alone, valued to-day at £1,500,000; or a financial loss of about £8000 in each factory in Java.

Von Lippmann has recently applied Kalshoven's method to 15 samples of final beet-molasses, with the following results:—

Beet-molasses

5	"	"	"	contained from 1·0% to 5·0% of crystals
7	"	"	"	5·0% to 10·0%
3	"	"	"	10·0% to 13·0%
Average of 15 samples = 7·0%				

The foregoing definitions lead to the following conclusions:—

(1) When the *final-molasses* obtained in the factory corresponds exactly to *exhausted molasses*, the contained sucrose is an *unavoidable loss*, due to the composition of the raw material treated, and fluctuating with variations in composition of this raw material. In such exceptional cases, the sucrose left in molasses should not appear under "*sucrose lost*," but form a separate item in the Factory Report.

It is important to note that a *low purity* in final molasses may indicate *bad work*, if due to inversion of sucrose during manufacture.

(2) In the majority of factories this *unavoidable loss* is supplemented by the *avoidable losses* referred to above, to an extent which is quite unknown. The composition of the *factory molasses* is ascertained by direct analysis, but the composition of the same molasses, when completely exhausted and free from crystals, can only be ascertained by special experiments, designed for this purpose.

Efficiency of Crystallisation

This is usually measured by comparing the *sucrose recovered* in commercial sugars made, with the *theoretical recovery* as expressed by the term *Available Sucrose* in the juice, and calculated by various formulæ. Deerr's formula was given in Chapter XV, pp. 151-153, and the example there given may

be repeated here. For juice of 85 Purity ($S = 0.85$), and for exhausted molasses of 42 Purity ($M = 0.42$).

$$\begin{aligned} \text{Then, Available Sucrose} &= \frac{S - M}{S(1 - M)} \\ &= \frac{0.85 - 0.42}{0.85(1.0 - 0.42)} \\ &= 0.872 \text{ per unit of sucrose in} \\ &\quad \text{juice.} \end{aligned}$$

Hence, 100 parts of sucrose in the juice should yield 87.2 parts of pure crystallised sucrose in the commercial sugars made, leaving a residue of exhausted molasses, of 42.0 Purity.

This *theoretical recovery* is based on the assumption that (M) represents the lowest possible purity in the molasses. Unfortunately, the purity of the *factory molasses* is frequently adopted for (M), thereby assuming complete exhaustion of this material, which is the very point in question. It is therefore necessary to prepare a sample of molasses which can be accepted as exhausted, and entirely free from crystals. The following method is suggested by the present writer.

Every month, one vacuum pan of *final massecuite* (not exceeding 60 *Apparent Purity*) is boiled with twice the usual proportion of grain (by adding *seed-grain*), and concentrated somewhat higher than in the usual routine practice. The massecuite is discharged into a large crystalliser (previously strongly heated by steaming) and slowly cooled in motion for twice the period adopted in the normal routine, the final temperature being noted. It is finally cured in the ordinary machines, but a sample of about two gallons is cured in a laboratory centrifugal (basket 12 inches diam.), fitted with a liner of the finest woven copper gauze. The sample is first heated to 45°–50° C., by immersing the container in a bath of hot water and stirring the massecuite continuously, the centrifugal being also heated by a steam-jet. The machine is run at quarter-speed when being charged with the warm massecuite, after which full speed is attained as quickly as possible. When the stream of separated molasses slackens off, the receiving vessel (A) is removed, and the final portion of separated molasses collected in a second vessel (B).

On examining single drops of the two portions under a microscope (magnifying about 100 diameters), A will generally be found to contain crystals (escaping through the copper liner), but B should be free. If B also contains crystals, the centrifugal (containing the cured sugar crystals) is again set in motion at full speed, sample B slowly poured in, and the escaping molasses received in a third vessel C. This portion is also examined under the microscope, and should be quite free from minute crystals.

The crystal-free molasses is then analysed, giving dry solids % (by refractometer, see p. 145), true sucrose % (by double polarisation, see p. 145), from which the *Optical Purity* (p. 148) is calculated by $\frac{\text{sucrose \%} \times 100}{\text{dry solids by refractometer}}$. The dry solids % should lie between 84 and 86%. If below 84%, the massecuite has not been sufficiently concentrated in the vacuum pan, and the sample of molasses may contain crystallisable sucrose in solution, in which case, the entire experiment must be repeated. If the dry solids exceed 86%, the massecuite has probably been concentrated too far, and the sample of molasses may contain less than its normal percentage of water. This, however, does not influence the *Optical Purity*, which is the figure to be ascertained, and adopted for (M) in the above formula for *Available Sucrose*. This purity should also be compared with the average purity of the *final molasses* obtained at the same date, but under normal working conditions, and the difference (if any) recorded. The same test is repeated monthly during the crop season in order to ensure average results for the whole crop.

In order that the *Available Sucrose formula* may serve to measure the efficiency of the crystallising operations alone, it is necessary to exclude the loss of sucrose in filter-press cake, as follows:—

(Sucrose in extracted juice) — (Sucrose lost in filter-press cake) = x parts of sucrose in syrup entering vacuum pans.

Then, available sucrose entering vacuum pans = $\frac{x(S - M)}{S(1 - M)} = y$ parts

and *Efficiency of Crystallisation* = $\frac{\text{Sucrose recovered in sugars made} \times 100}{y}$

This *possible recovery* (y) can only be approximately true

because the formula assumes that the fall in purity from (S) of the juice to (M) of the final molasses, is solely due to the removal of sucrose as crystals, with no change in the other constituents of the juice. But, in practice, the non-sugars undergo numerous changes, some being precipitated and removed by filtration, others are decomposed during evaporation of water and boiling in the vacuum pan, and others are deposited as "scale" on the metal heating-surfaces. Again, any slight inversion during manufacture will lower the purity (S) of the juice by *destruction* of sucrose instead of by *extraction of crystals*.

To eliminate these errors, it would be necessary to accurately measure the whole of the syrup before it passes to the vacuum pans, to calculate its weight from its average density, to determine the sucrose % and Purity in average samples, and thus arrive at the value (x) directly. The average purity of the syrup would then be substituted for purity (S) of the juice in the formula. This method presents so many difficulties as to be almost impracticable.

The alternative course is to admit that the *Available Sucrose in the juice* is only an approximate guide, and to establish a ratio between the *factory yield* and the *theoretical yield* (y). Variations in this ratio will then correctly indicate variations in factory efficiency, even though an accurate measure of efficiency is lacking. For this purpose, it is essential to use the *same formula*, and the same methods of testing the purities of the juice and molasses for a series of years.

For further details of "chemical control" the student should refer to the following works:—

Geerligs' *Methods of Control in Java Cane Sugar Factories*.

„ *Practical White Sugar Manufacture*.

Spencer's *Handbook for Cane Sugar Manufacturers and Chemists*.

„ *Handbook for Chemists of Beet Sugar Factories*.

Methods of Chemical Control adopted by the Hawaiian Chemists' Assoc., published in *The International Sugar Journal*, Vol. XVIII, pp. 468, 513, and 553.

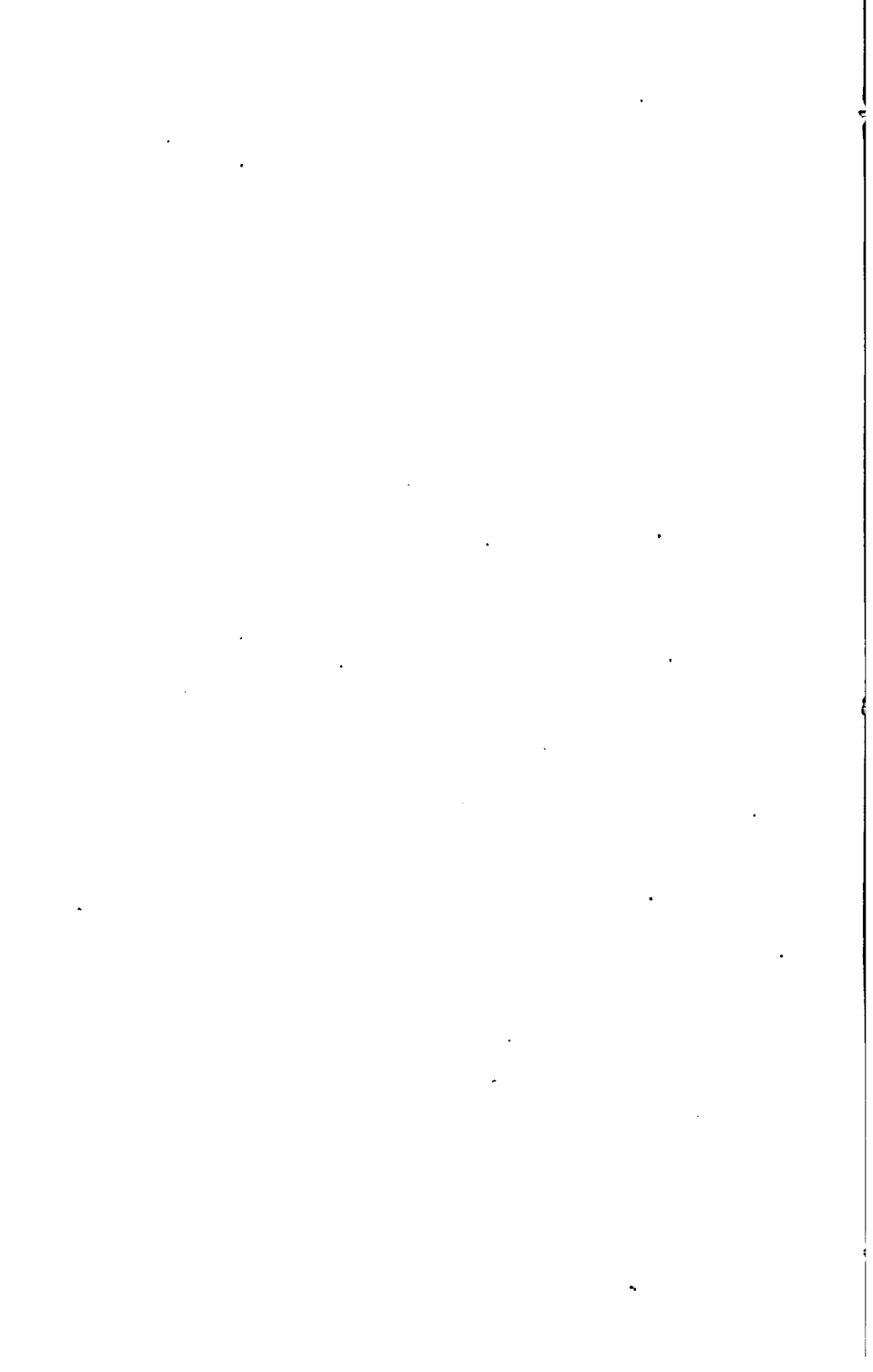

PART VIII
SPECIAL METHODS OF EXTRACTING SUGAR
FROM MOLASSES

CHAPTER 28. TREATMENT OF BEET-MOLASSES

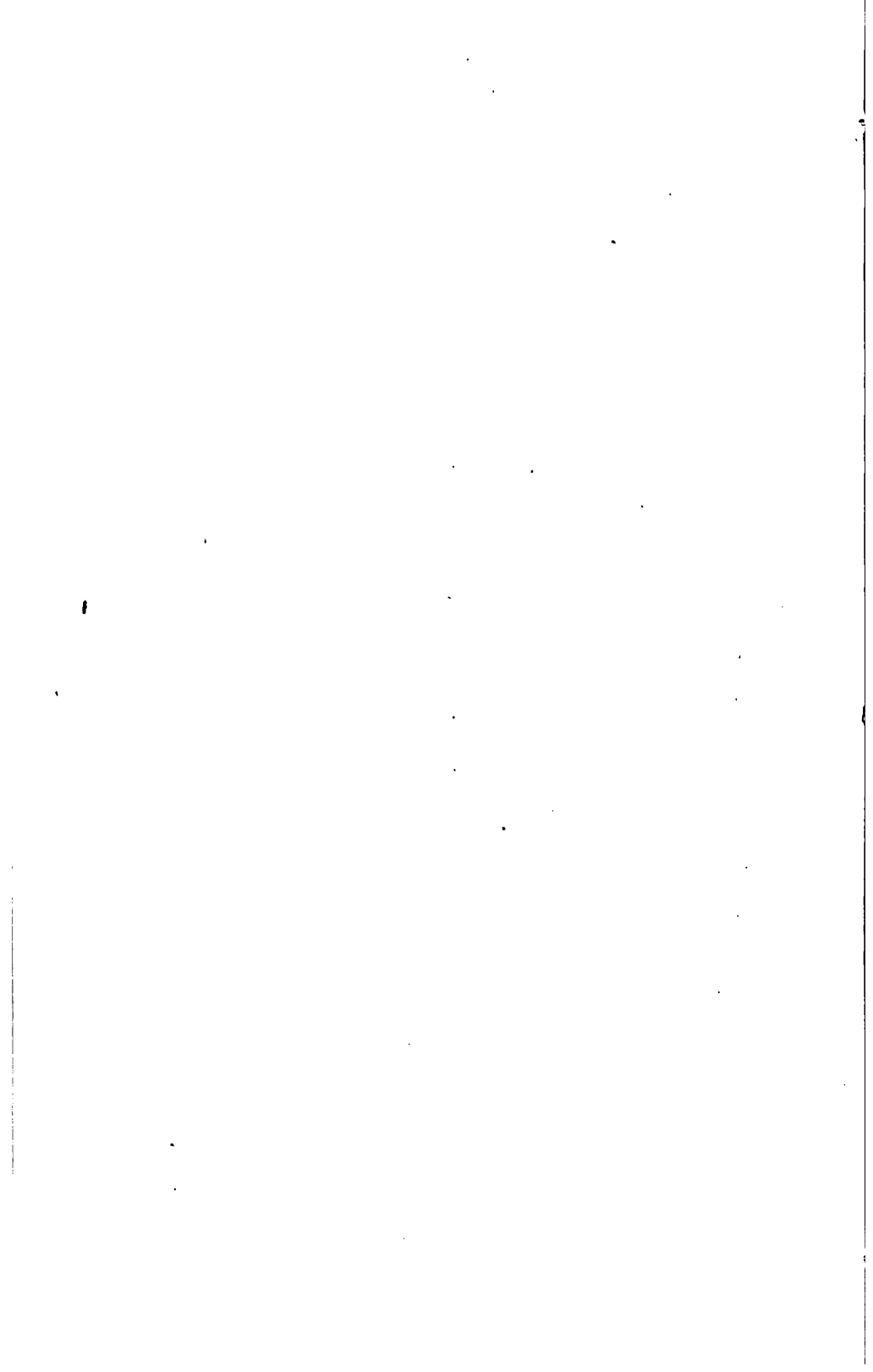

CHAPTER XXVIII

TREATMENT OF BEET-MOLASSES

THE foregoing section dealt with the crystallisation of sucrose due to the evaporation of its aqueous solution ; beet juice yielding a final product containing about 50% of sucrose, which fails to crystallise on further evaporation of water, followed by cooling. It appears highly probable that the contained sucrose is chemically combined with certain non-sugars forming uncrystallisable hydrated compounds (see Geerligs' definition of exhausted cane-molasses on p. 324).

On mixing beet-molasses with an equal volume of glacial acetic acid, about 75% of the contained sucrose separates in the form of small crystals after the mixture has stood for 12 hours, and without further evaporation of water. The crystals can be separated by filtration, washed with strong alcohol and dried, and then represent nearly pure sucrose. Geerligs remarks that this mode of separation confirms his theory regarding the nature of molasses ; for the acetic acid appears to decompose the sucrose-salt combination, thus setting the sucrose free. This method of extracting sugar from beet-molasses was patented in 1863, 1869, and 1882, but did not prove a commercial success owing to the difficulty of recovering the acetic acid. It has been employed in the laboratory for the separation of rare sugars from impure solutions.

When cane-molasses is treated in the same manner no sucrose-crystals are formed, and Geerligs accounts for this by the inability of the acetic acid to decompose the more stable compounds of sucrose + reducing sugars + salts present in cane-molasses.

If cane- or beet-molasses be freely diluted with pure water,

the contained compounds are dissociated into *free sucrose* + *free non-sugars*, but in this case the sucrose is kept in solution by the large excess of water. On evaporating this water in the vacuum pan, the sucrose-salt compound is gradually re-formed and the final result is exactly the same as before the water was added.

The practical methods of extracting sucrose from beet-molasses fall under two heads, namely:—(1) Dialysis (or osmosis) through parchment-paper, and (2) Precipitation of the sucrose as an insoluble saccharate by the addition of lime, strontia, or baryta.

(1) THE OSMOSIS PROCESS

This was at one time extensively employed in France and Germany, but has been gradually abandoned in favour of method (2).

As the theory of dialysis was considered in Chapter IX (pp. 75–76) we may here proceed to its application to the problem under consideration.

The *Osmogene*, invented by Dubrunfaut in 1863, closely resembles the filter-press (Fig. 19) in external appearance, and consists of numerous frames (from 50 to 100) separated from each other by sheets of parchment-paper, the frames and papers being clamped together between two terminal metal plates by means of a screw. The sheets of parchment-paper act as *dialysers*, and each *dialysing-cell* consists of one frame and the two adjacent papers. Diluted molasses enters the first dialysing-cell at one extremity of the apparatus and flows continuously through every alternate cell until it escapes at the opposite extremity of the apparatus. Water enters the last cell and flows continuously through every alternate cell until it reaches No. 2 at the opposite extremity of the apparatus. The two liquids—molasses and water—therefore travel in opposite directions through alternate cells, being separated by the parchment-papers between the numerous frames.

As the saline constituents of the diluted molasses dialyse more rapidly than sucrose, they pass through the papers into

the water-cells, thereby reducing the ratio of $\frac{\text{saline matters}}{\text{sucrose}}$ in the molasses passing from cell to cell. Similarly, the saline matters accumulate in the water during its motion in the opposite direction. This "counter-current" principle allows dialysis to continue in every cell, because the dialysed molasses is always adjacent to the water-cells containing less saline matter, whereas the saline water is always adjacent to molasses-cells containing still more saline matter. The molasses to be treated is diluted to about 45° Brix, and heated to about 80° C. before entering the osmogene, the water employed in the osmogene being also heated to this temperature. After treatment, the molasses has a density of from 35° to 40° Brix, and the saline-water has a density of 3° Brix (part of which is due to sucrose). This saline-water is concentrated for the extraction of potash salts.

An osmogene having 50 frames can treat from 1200 to 1250 kilos. of molasses per 24 hours, and one having 100 frames can treat 3000 kilos. of molasses. The parchment-papers must be renewed about once a week, and are thoroughly washed with hot water daily.

The treated molasses is *boiled smooth* in the vacuum pan, crystallised in motion, and the resulting sugar cured in the ordinary way. The molasses thus separated is usually again dialysed, re-boiled, and crystallised. By repeating these operations it is possible to extract from 25 to 30% of the sucrose in the original molasses. The final-molasses may be fermented, thus converting the remaining sugar into alcohol.

In order to avoid increasing the dilution of the molasses during osmosis, Leplay introduced his *evaporating osmogene* in 1884. In this apparatus the alternate molasses-cells are extended vertically upwards, forming a shallow reservoir or box on the top of the osmogene, in which a steam-coil is inserted. Water is thus evaporated as the molasses passes from each cell to the next. The osmogene and various improvements are illustrated and fully described in Ware's *Beet Sugar Manufacture and Refining*, Vol. II (pp. 469-481).

(2) SACCHARATE PROCESSES

General Principles.—The formation and composition of the saccharates have been described in Chapter XII (p. 113).

A dilute solution of molasses is mixed with a sufficient quantity of lime, strontia, or baryta, to form an insoluble saccharate which can then be separated by filtration. The cakes of saccharate are washed free from the original impure liquid by passing water through the filter, and are then discharged.

The sucrose may be extracted from the cakes by mixing them with water and precipitating the alkali-constituent as an insoluble carbonate, thus:—

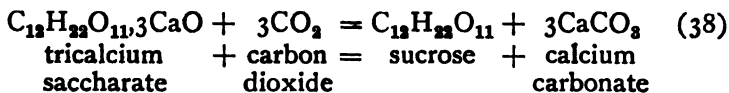

After this precipitate has been removed by filtration, the filtered sucrose solution can be concentrated and crystallised. But this method necessitates the addition of much water to the cakes, followed by evaporation of this water.

A more practical method consists in adding the saccharate cakes to the raw beet-juice, thus utilising the alkali of the cake for purifying the juice (in the place of quicklime), whilst the sucrose of the cake is added to that in the juice and converted into crystals during the normal factory routine.

The saccharate processes are not applicable to cane-molasses because this material contains a large percentage of reducing-sugars. The latter combine with alkalis to form compounds analogous to saccharates (i.e. *glucosates* and *fructosates*) but which readily decompose, forming alkaline salts which render the saccharate impure. But, in the Battelle Process of treating cane juice (see p. 197), the reducing-sugars are destroyed by boiling the juice with an excess of lime, and the molasses derived from this juice resembles beet-molasses, and can be treated by the following processes, hitherto only applicable to beet-molasses.

The saccharate processes may be classified according to the alkali employed, and it will be convenient to consider them in their historical order.

The Baryta Process

This was patented by Dubrunfaut and Leplay in 1859, and closely resembles the more recent lime- and strontia-processes described below. The baryta was prepared by roasting the mineral *witherite* (barium carbonate). Langen and Felde employed barium sulphate (*heavy spar*) as starting point, and prepared a hydroxy-sulphide of barium by heating a mixture of the pulverised barium sulphate, coal, and oil to redness. The barium hydroxy-sulphide was added to diluted molasses and yielded a precipitate of barium saccharate:— $C_{12}H_{22}O_{11},BaO$. This was separated in filter-presses and added to the juice during the second carbonation, the barium being then precipitated as barium carbonate. In Dubrunfaut's Process, this barium carbonate was converted into barium oxide by heat, and finally into barium hydroxide, for use over again. In Langen and Felde's Process, the barium carbonate was re-converted into barium hydroxy-sulphide for use over again, by means of a complicated chemical process which need not be described here. The baryta process has now been abandoned in favour of the following methods.

Lime-saccharate Processes

(a) *Scheibler's Process* (1862).—This was based on the formation of insoluble tricalcium saccharate, $C_{12}H_{22}O_{11},3CaO$, and its separation from the non-sugars by washing the precipitate with alcohol.

Recently slaked lime was added to molasses in the proportion of 3 molecules of lime per molecule of sucrose present, and the semifluid mixture gradually heated to 100° C. until dry and powdery. After cooling, it was washed with alcohol in special vessels called "elutors," and the washed saccharate added to the diffusion-juice in the place of quicklime. During carbonation of this juice, the lime-constituent of the saccharate was precipitated as insoluble carbonate, leaving the sucrose in the juice, to be subsequently converted into crystals. The alcoholic washings were distilled in order to recover the alcohol for use over again, but some loss of alcohol was unavoidable during the various operations.

The process was improved by Seyfert in 1872, by substituting quicklime for slaked-lime, the added lime becoming slaked on contact with the water in the molasses, and evolving sufficient heat to evaporate this water. The dried saccharate was then washed with alcohol, as in the original process.

Scheibler finally substituted strontia (see below) for lime, it being possible to wash the strontium saccharate with water, thus dispensing with the costly agent—alcohol.

(*b*) *Steffen and Drucker's Process*.—This differs from Scheibler's Process in three respects, namely:—(*a*) by operating with diluted molasses; (*b*) by producing the tricalcium saccharate indirectly; and (*c*) by employing water instead of alcohol for washing the saccharate. The process involves the following operations:—

- (1) Dilution of the molasses with water to a density of 11° – 12° Brix.
- (2) Addition of slaked lime in the proportion of one part of CaO to one part of sugar in the diluted molasses, forming the soluble monocalcium saccharate.
- (3) Filtration, to separate any non-sugars precipitated by the added lime.
- (4) Heating the filtered solution to 105° C. for a few minutes, in order to convert the monocalcium saccharate into the insoluble tricalcium saccharate.
- (5) Separation of the latter by filter-pressing, and washing the cakes with hot water.
- (6) The filtered liquid from (5) (containing the non-sugars and part of the sucrose originally contained in (1)) is used for diluting a second portion of molasses to a density of 11° – 12° Brix, and the above operations repeated, thus obtaining a second quantity of washed saccharate in (5) and a second filtrate. The latter serves for diluting a third portion of molasses, and the above routine may be repeated 20 times, after which the liquid becomes too highly charged with non-sugars and must be thrown away. A fresh start is then made as in (1).

The tricalcium saccharate, obtained in (5), is used for liming

the diffusion-juice, as in method (a). The process was employed for many years, but has been discarded in favour of the following.

(c) *Steffen's Separation Process*, patented in 1883.—This resembles (b) in operating with diluted molasses, also in washing the cakes of saccharate with water ; but the saccharate is here formed directly by working at a low temperature. The process involves the following operations :—

- (1) Dilution of the molasses with water to a density of 12° Brix (or 7% sugar). This dilution is generally effected by adding the filter-press washings (see (3) below).
- (2) The dilute liquid is cooled to 12°–15° C. in a special apparatus called the "Precipitator," and finely-ground quicklime is gradually added with constant stirring, in the proportion of one part of lime to one part of sucrose in solution, causing tricalcium saccharate to be precipitated.
- (3) Separation of this precipitate by filter-pressing, followed by washing the cakes of saccharate with cold water (12° C). As the saccharate is slightly soluble in cold water, the filtered washings contain sucrose and are used for diluting fresh portions of molasses (see (1) above). After moderate washing, the dry solid matter of the cakes contains 90% of saccharate, and, with more thorough washing, up to 95%.
- (4) The cakes are mixed with water to form a cream, and added to the diffusion-juice in the place of quicklime.
- (5) The main filtrate (before washing the cakes) contains about 0.5% of sucrose (in the form of soluble saccharate). On heating this to 90° C., most of the contained sucrose is precipitated as tricalcium saccharate.
- (6) Separation of this precipitate by a second filtration, followed by washing the cakes with hot water. The main filtrate and washings are converted into fertilisers (see p. 383).

The practical details may now be considered.

Lime.—This must contain the minimum percentages of magnesia, alumina, and silica, and should be recently burnt, but quite cold. The success of the process depends very largely on the fineness of the crushed lime. In the United States, the Raymond Crusher has proved very successful; the finest lime-dust being transported from the crusher by a current of air and deposited in a "cyclone," similar to that used in flour-mills. The coarser particles of lime are not removed by the air-current but gravitate back to the crushing-rollers for further grinding. This method eliminates sifting before re-grinding.

The quantity of lime added to the diluted molasses is regulated by the alkalinity of the filtrate from the saccharate cakes, which should correspond to 0.8% CaO. The weight of added lime varies between 90 and 175 parts per 100 parts of sugar in the diluted molasses. An excess of lime should be avoided as it rapidly corrodes the filter-cloths.

Precipitation.—The "Precipitator" is a cylindrical vessel, closely resembling the heating-chamber (calandria) of a vertical, multiple-effect evaporator (Fig. 23) but designed for cooling instead of for heating. Cold water (10°–12° C.) is circulated through the space surrounding the tubes, whilst the diluted molasses is circulated through the tubes by means of a mechanical agitator rotating in a central, vertical chamber, and making 200 revolutions per minute. The molasses-liquor is thus caused to move upwards through this central chamber, and downwards through the numerous cooling-tubes of small diameter. As soon as the molasses-liquor has been cooled to 12°–15° C., the crushed lime is gradually added through a hopper at top of the vessel, and immediately mixes with the rapidly circulating liquor. By adding small quantities at a time, the temperature of the mixture can be kept below 15° C., owing to the cooling action of the water surrounding the tubes.

Filtration.—Hemp filter-cloths are used, but are rapidly corroded if the liquid contains an excess of lime. Filtration is carried out under a pressure of 1.8 atmospheres, and presents no difficulty. The filtered liquor represents from

eight to ten times the volume of the original molasses (before dilution), and contains about 0.5% of sucrose, or about 5.0% on weight of undiluted molasses. This sucrose is recovered as tricalcium saccharate as explained under stage (5) above.

Saccharate Cakes.—When discharged from the filter-press, the cakes contain from 12 to 15% of sucrose, and from 15 to 20% of CaO. Sometimes the percentage of sucrose exceeds that of lime, but, normally, the cakes consist of a mixture of tricalcium saccharate and uncombined lime. They are mixed with water to a thick paste which is then diluted to a cream by the addition of carbonated juice. On adding this cream to the raw diffusion-juice, the saccharate decomposes with formation of the soluble monocalcium saccharate and insoluble calcium hydroxide, the non-sugars being precipitated in the same manner as when adding quicklime. When a factory treats its own molasses by this process, the saccharate supplies the quantity of lime required for the chemical treatment of the juice. Some factories also buy molasses to treat in addition to their own, in which case an excess of saccharate is produced. Claassen recommends mixing this excess with raw diffusion-juice, calcium hydroxide being precipitated, removed by filtration, and washed. This is added to the diluted molasses, in which it dissolves forming monocalcium saccharate, thereby reducing the quantity of crushed quicklime required for treating the molasses. ✓

The saccharate generally contains a small percentage of raffinose and certain non-sugars which retard crystallisation of the sucrose during boiling in the vacuum pan. ✓

Strontia-saccharate Process

The use of strontia was first patented by Dubrunfaut and Leplay in 1849, and introduced into German beet-sugar factories by Fleicher in 1869. The process was modified and improved by Scheibler, whose patents are dated 1881, 1882, and 1883.

Scheibler's Distrontium Saccharate Process.—This has been extensively used in Germany, and involves the following operations:—

(1) A hot 25% solution of strontium hydroxide is prepared in a vessel fitted with a steam-coil and mechanical stirrers.

(2) One-third of this volume of molasses is gradually added, with continued heating and mixing, also sufficient crushed strontium hydroxide until the mixture has an alkalinity of 12 to 13% SrH_2O_2 . The total quantity of strontium hydroxide used is in the proportion of 2.5 parts to 1 part of sucrose in the molasses.

(3) The distrontium saccharate, thus precipitated, is separated in bag-filters (with steam surrounding the bags), and washed with a hot 10% solution of strontium hydroxide.

(4) The washed saccharate is transferred to metal cooling-vessels, dissolved in a cold 2% solution of strontium hydroxide, and the resulting solution cooled below 10°C ., and left to stand. After three days, one-half of the contained strontium hydroxide deposits as crystals, leaving the remaining strontium hydroxide and all the sucrose (from the distrontium saccharate) in solution.

(5) The bulk of the clear liquor is separated from the crystals by decantation, and the remainder by centrifugal machines, and treated with carbon dioxide gas until the alkalinity is reduced to 0.05% SrH_2O_2 , thus precipitating the strontia as carbonate.

(6) Separation of the strontium carbonate by filter-pressing, followed by washing with hot water.

(7) The filtrate from (6) is boiled and grained in the vacuum pan, and yields white sugar-crystals for direct consumption.

(8) The crystals of strontium hydroxide, separated in (5), are used for treating fresh portions of molasses.

(9) The strontium carbonate, separated in (6) is converted into strontia (SrO) by ignition, and again into strontium hydroxide, and used for treating fresh portions of molasses.

PART IX
. BY-PRODUCTS

- CHAPTER 29. BY-PRODUCTS OF THE CANE-SUGAR FACTORY**
„ 30. BY-PRODUCTS OF THE BEET-SUGAR FACTORY

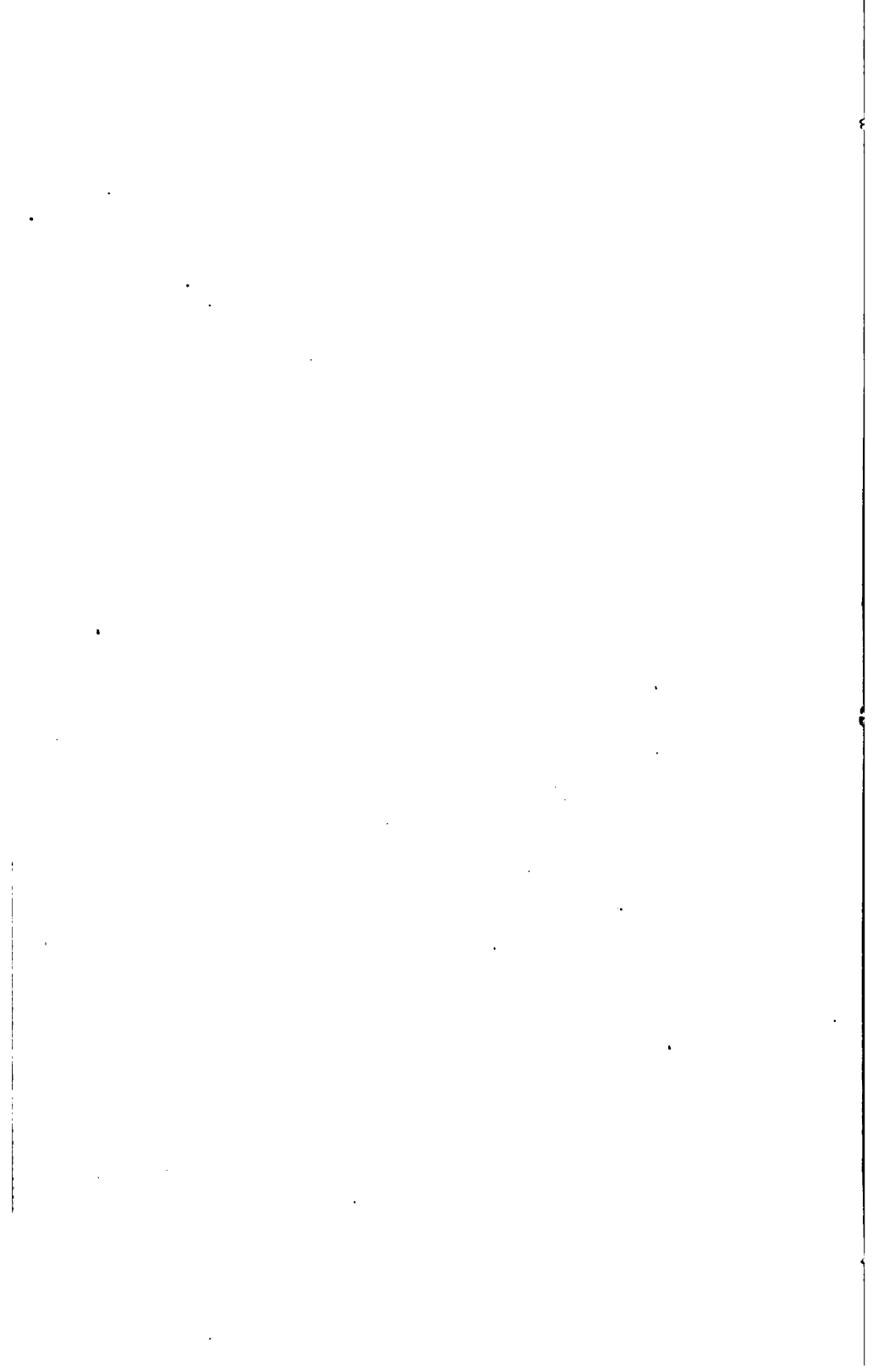

CHAPTER XXIX

BY-PRODUCTS OF THE CANE-SUGAR FACTORY

FROM 100 tons of canes crushed, there are obtained, approximately :—

25 tons of bagasse, which is mainly used as fuel.

2½ tons of filter-press cake, mainly used as a fertiliser.

2½ to 3 tons of final-molasses, used in the production of alcohol, also as fuel, fertiliser, and food for stock.

(I) BAGASSE (OR MEGASS)

Composition.—This varies considerably when the bagasse is derived from different varieties of cane, and when different pressures are applied during milling. Assuming average canes, and a fourteen-roller mill, the bagasse has approximately the following composition :—

Water	47·5
Fibre	47·0
Sugar	4·0
Mineral Matters	1·0
Organic non-sugars	0·5
	100·0

(a) Fuel Value

Under this heading, it is necessary to distinguish between the following terms :—*gross calorific value*, *net calorific value*, and *available heat*, all being expressed *per pound of moist bagasse* entering the furnace. The *gross calorific value* expresses the total heat-units evolved during combustion, including the heat-units in the gaseous products formed, and those in the water-vapour derived —(a) from the moisture in the bagasse, and (b) from the water produced by combustion

of the hydrogen in the dry bagasse. This value is determined experimentally in the bomb-calorimeter and some results are given in the following Table.

TABLE XIII.—CALORIFIC VALUE OF DRY BAGASSE

	B.T.U. per Pound of Moisture-free Bagasse.		
	<i>Maximum.</i>	<i>Minimum.</i>	<i>Mean.</i>
Louisiana	8431	8283	8368 } by Kerr
Cuba	8650	8300	
Hawaii	—	—	8100 by Norris
Java	8514	8249	8381 by Geerlign
			Mean . 8320

This mean value serves as a basis for the calculations which follow.

$$\text{Gross calorific value of moist bagasse} = \frac{8320 (100 - \text{water } \%) }{100}$$

$$\text{Examples :—Bagasse containing 48\% water} = \frac{8320 \times 52}{100} = 4326 \text{ B.T.U.}$$

$$\text{,, ,, 45\% ,,} = \frac{8320 \times 55}{100} = 4576 \text{ ,,}$$

Available Heat

$$\begin{aligned} \text{Gross calorific value of moist bagasse} &= \text{Available B.T.U. for use in boiler} + \text{B.T.U. lost in chimney} \\ &= (a) = (x) + (b) + (c) + (d) \end{aligned}$$

(b) Water-vapour from moisture in bagasse
 (c) Water-vapour from hydrogen in bagasse
 (d) CO₂, N, and O

And $x = a - (b + c + d)$.

As the hydrogen in bagasse is already combined with oxygen, the heat generated in the furnace is due to combustion of the carbon, as expressed by the following equations.

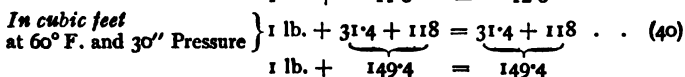
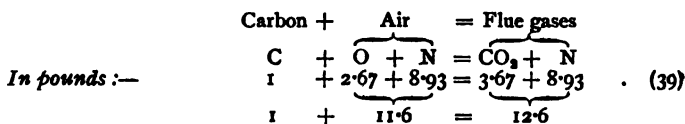

Let moist bagasse contain W% free water, F% dry fibre, and S% sugar.

Then Carbon % = $\frac{F \times 44.44}{100} + \frac{S \times 42.11}{100} = C\%$

and Hydrogen % = $\frac{F \times 6.17}{100} + \frac{S \times 6.43}{100} = H\%$ { producing 9H parts of water.

Then, from equation (39)—

Pounds of Gas.

Per pound of bagasse— $\left. \begin{array}{l} \frac{C}{100} \times 3.67 = CO_2 \\ \frac{C}{100} \times 8.93 = N \end{array} \right\}$ with theoretical quantity of air.

Assume that air entering furnace = $1\frac{1}{2}$ times the theoretical quantity :—

Per pound of bagasse— $\left. \begin{array}{l} \frac{C}{100} \times \frac{2.67}{2} = O \\ \frac{C}{100} \times \frac{8.93}{2} = N \end{array} \right\}$ present in excess air.

The total weight of $CO_2 + N + O$ is heated from air-temperature (t_A) and escapes to the chimney at the temperature (t_0).

The specific heats of the three gases are—0.22, 0.24, and 0.24 respectively ; and of steam—0.47.

Heat lost in gases per pound moist bagasse } = $(CO_2 \times 0.22 + N \times 0.24 + O \times 0.24)(t_0 - t_A) = \text{B.T.U.}$

Heat lost in water-vapour per pound moist bagasse =

To heat 1 pound of water from t_A to 212°F. requires $212 - t_A$ B.T.U.

To convert this water into steam at 212°F. requires 966 B.T.U.

To superheat this steam to temperature t_0 requires $0.47(t_0 - 212)$ B.T.U.

Then—

Per pound moist bagasse = $\frac{W+9H}{100} [(212 - t_A) + 966.0 + 0.47(t_0 - 212)] \text{ B.T.U.}$

By giving actual values to W, F, S, t_A and t_0 , the *available heat* can be easily calculated for bagasse containing different percentages of moisture ; for different chimney-temperatures ; and for different quantities of excess air entering the furnace.

Example.—Let $W = 48\%$, $F = 48\%$, $S = 4.0\%$, $t_A = 85^\circ \text{F.}$ $t_0 = 500^\circ \text{F.}$, and air entering furnace = $1\frac{1}{2}$ times the theoretical quantity.

The previous equation then gives the following results :—

Gross calorific value = Available B.T.U. + $\overbrace{\text{B.T.U. lost in chimney}}$

(a)	=	(x)	+	(b)	+	(c)	+	(d)
4326	=	2966	+	589	+	356	+	415
				1360				

Some engineers and writers adopt the following definition:— *Available B.T.U. or net heating value* = $(a) - (b)$, and others adopt $(a) - (b + c)$. But, it is obvious that neither of these can indicate the value (x) unless the loss (d) is also taken into consideration. The terms "*net heating value*" or "*net calorific value*" are misleading, and should be discarded.

In addition to the loss of heat in the chimney, there are losses due to unburnt carbon in the furnace-ashes; to incomplete combustion, with formation of carbon monoxide; and loss by radiation. As these cannot be directly determined, they are usually assumed to be equal to one-tenth of the gross calorific value, thus giving a corrected value of (x) :—

$$\begin{aligned} (4326 - 1b) - 1360 &= 2534 \text{ B.T.U. used in steam boiler.} \\ &= 58.6\% \text{ of the gross calorific value.} \end{aligned}$$

and capable of evaporating $\frac{2534}{966} = 2.62$ pounds of water from, and at 212°F .

On comparing this result with average coal, one pound of which evaporates about 10 pounds of water from, and at 212°F ., we obtain the ratio:—

$$\frac{10}{2.62} = 3.8 \text{ pounds bagasse (48\% water) = 1 pound average coal.}$$

Although the gross calorific value of moist bagasse fluctuates with the percentage of contained moisture, this does not sufficiently explain the remarkable differences in steam-producing power experienced in different factories. Those which are equipped with all modern appliances for economising steam, may obtain a slight surplus of bagasse, available for raising steam for those factory operations which continue after the mill stops. Other factories have no surplus bagasse, and burn final molasses along with the bagasse. Others, again, have to supplement the bagasse with wood, oil, or coal.

(1) The main cause of such differences is found in the fibre-content of the canes crushed, since this determines the ratio of juice, and therefore of water to be evaporated per unit of fibre.

Secondary causes include the following:—

(2) The quantity of maceration water added during milling, which increases the ratios just mentioned.

(3) The physical properties of the bagasse-fibre. Geerligs has shown that the same weight of bagasse, derived from different varieties of cane, occupies very different volumes, and this variation determines the weight of bagasse which can be burnt *per square foot of grate-area* in the furnace. As the ratio $\frac{\text{Heating-surface in boiler}}{\text{grate-area}}$ is fixed, once for all, by the

designer of the furnace, any variations in the apparent density of bagasse must influence the steam-producing power of a given boiler and its furnace. A very porous bagasse cannot be burnt sufficiently rapidly to produce the same number of heat-units per hour as a denser form of bagasse, *on the same grate-area*, although the calorific value *per pound weight* may be identical in the two materials. The porous bagasse may therefore accumulate outside the furnaces (implying an abundance of fuel) yet the boilers fail to supply sufficient steam for the normal requirements of the factory. The only remedy is to provide a spare boiler and furnace which can be brought into action when necessary.

(4) A very porous bagasse, burnt under natural draught, allows too much air to enter between the grate-bars per unit weight of bagasse burnt, and such excess air increases the heat-losses in chimney, as explained above.

The furnace-ashes represent the by-product, and are utilised as fertiliser. Geerligs gives the following composition of the carbon-free ash:—

Silica	80.6
Iron and calcium phosphate	6.9
Calcium carbonate	0.8
Potassium carbonate and hydroxide	11.7
	<hr style="width: 100%;"/>
	100.0

(b) *Paper from Bagasse*

Deerr records that the first patent for producing paper from bagasse was issued in 1838, followed by unsuccessful experiments in 1852-3; and a further patent, describing the process and machinery, in 1873.

The first large-scale experiment was made in a Texas

sugar factory, where the cane was treated by diffusion. The cane slices from the battery contained 82% water, 16.5% crude cellulose, 0.75% carbohydrates, and 0.75% ash. After chemical treatment with soda and quicklime, and washing, about 20% by weight of strong wrapping-paper was obtained, valued at £9 6s. per ton. This experiment proved a commercial failure, and had to be abandoned.

A more successful venture was at Tacarigua Estate, Trinidad, using ordinary bagasse from the cane-mill, mixed with bamboo and Para grass in the proportions 65%, 20%, and 15% respectively. This mixture, after suitable chemical treatment, produced a wrapping-paper which could be printed upon, and was valued at £5 4s. per ton. Paper made from bagasse alone was manufactured commercially at the Preston Central Sugar Factory, Cuba, in 1915, the paper factory employing 25 men and producing 4 tons of bagasse-paper per day. Three qualities of wrapping-paper were first produced, and additional machinery has been erected for the production of superior grades of paper.

In Lees Patent of 1914, the bagasse is dried by means of waste furnace-gases until the moisture-content is reduced to 15-25%, then passed through a "pulveriser," which separates the pith from the rind, this separation being completed by sifting. The "selected fibre" is then converted into paper.

In Marsden's Patent of 1916, the bagasse is also partially dried, cut into short pieces, and packed in bales for shipment to the paper manufacturer, or stored at the sugar factory for subsequent conversion into paper by the following process. The bagasse is heated with steam at 10 to 25 pounds pressure to extract the soluble matters, then digested with alkali at a steam pressure of 30 to 60 pounds to extract the lignin, followed by washing, beating, and bleaching. It is claimed that the process produces an excellent newspaper material, and the bagasse-pulp may be combined with other fibres in the manufacture of superior grades of paper.

In 1918, Eckart patented a method of destroying weeds in the cane-fields by covering the young cane-shoots with asphalt-felt or tarred paper. The growing cane-shoots pierce the covering material, whereas the weeds fail to penetrate it,

and consequently wither and die. The paper covering also acts as a "mulch" for conserving soil-moisture, and can be transported from field to field. For the application of this field-process, Eckart is now manufacturing a suitable paper from bagasse at the Oloa Sugar Factory, Hawaii, and proposes to manufacture other grades of bagasse-paper for export.

Whether bagasse can be more profitably employed to-day in the manufacture of paper than as fuel, cannot be judged from the estimates at present available, as these are based on pre-war conditions. The main considerations are—the cost of fuel to be substituted for bagasse in the sugar factory, and a sufficient supply of pure water for washing the pulp.

(c) "*Molascuit*" Cattle-food

This will be referred to under "Molasses" below.

Proposals which have not yet been adopted in Practice.

(d) *Cane Wax from Bagasse*.—The Simmons Sugar Co., of Mass. U.S.A. have patented a process of extracting cane-wax during the conversion of bagasse into paper. The bagasse is digested with caustic soda solution (49° Twaddle) under steam-pressure of 13 to 30 pounds, followed by washing to remove extracted matters. It is again digested with additional caustic soda solution under steam-pressure of 40 pounds, and again washed. The residual washed fibre is converted into paper, and cane-wax is extracted from the caustic soda solution used for the second digestion by concentrating this to one-fourth its volume, and allowing the wax to rise to the surface as a scum. This scum is removed by skimming-ladles and purified in any convenient way. The alkaline liquors, after separation of the wax, can be used for treating further quantities of bagasse. Cane-wax is usually extracted from filter-press cake (p. 354).

(e) The production of *methyl alcohol, acetic acid, acetone, and charcoal* by destructive distillation of bagasse in retorts. In this case, wood, oil, or coal would be necessary for steam-production in the sugar factory.

(f) Coxon proposes to burn bagasse with a restricted

supply of air in an ordinary *producer*, thus obtaining *producer-gas* as a fuel for raising steam in the sugar factory, after extracting acetic acid and other condensable products therefrom. The formation of this gas is shown in the following equations.

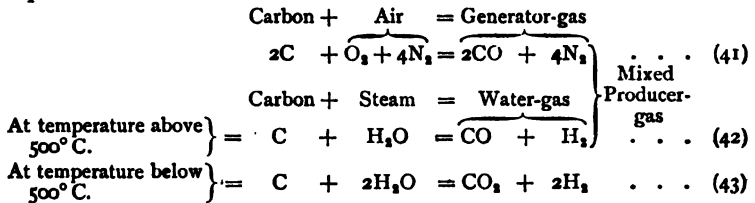

By equation (41) 100 parts of air yield 34.7 parts of carbon monoxide and 65.3 parts of nitrogen; but, in practice, some carbon dioxide is also formed.

If steam be blown through red-hot carbon in the *producer*, additional carbon monoxide is formed, also hydrogen gas (equation (42)). As bagasse contains about 48% water, this would act in the same manner as steam. By burning bagasse in a *producer* instead of in the present type of furnace, the heat-losses due to excess air and evaporated moisture would be eliminated. By washing the producer-gas before using it as fuel, Coxon estimates that about 3 tons of calcium acetate could be produced per 100 tons bagasse, equal to $\frac{3}{4}$ ton of calcium acetate per 100 tons of cane crushed. He quotes the following prices per ton.

	1913.	1918.
Calcium acetate	£ 12	£ 40
Acetic acid	37	200
Acetone	74	200

(g) The manufacture of alcohol from bagasse by hydrolysis of the cellulose and fermentation of the resulting glucose.

(2) FILTER-PRESS CAKE

In the raw-sugar factory, where small quantities of lime are added to the juice, 100 tons of cane yield about $2\frac{1}{4}$ tons of

moist filter-press cake (70% water), equal to 0·6 to 0·8 ton dry solid matters. In the white-sugar factory, adopting the carbonation process, 100 tons of cane yield from 7 to 12 tons of moist cake (50% water) equal to 3½ to 6 tons of dry solid matter.

The compositions of the moisture-free cakes are given in the following Table, derived from Geerligs' *Cane Sugar and its Manufacture*, and an article by W. E. Cross.

TABLE XIV.—COMPOSITION OF FILTER-PRESS CAKES FROM CANE JUICE

	Defecation and Sulphitation Processes.			Single Carbonation.	Double Carbonation (Java).		
	Java.		Louisiana.	Argentine.	Java.	First Carbonation.	Second Carbonation.
Nitrogen	1·2	1·0	2·10	2·40	0·41	0·43	nil
Phosphoric acid	3·8	4·6	6·3	6·3	0·71	0·87	0·12
Lime	—	5·1	—	6·6	—	—	—
Sand and clay	—	9·3	—	7·1	2·48	4·37	nil
Sucrose	—	34·0	—	33·0	4·00	10·10	8·10
Organic non-sugars	—	39·0	—	40·2	12·01	15·00	4·70
Calcium carbonate	—	—	—	—	67·94	61·94	85·01
Magnesium „	—	—	—	—	1·80	1·21	0·10

(a) *Used as Fertiliser*

The manurial value of defecation- and sulphitation-cakes is mainly due to the contained nitrogen (about 2·0%) and phosphoric acid (about 5·0%). Of the latter constituent, about 80% is soluble in ammonium citrate and represents "available phosphoric acid," which is of higher value than the insoluble form. One ton of *dried cake* contains about 45 pounds of nitrogen, 90 pounds of available phosphoric acid, and 22 pounds of insoluble phosphoric acid. From the current market price per cent. of each constituent in commercial fertilisers, the values per ton of *dry cake* and per ton of *moist cake* are easily calculated. Cross estimates the value of air-dried cake (containing about 10% water) at \$10 to \$12 per ton, equal to about 15s. per ton of *moist cake*, containing 70% water.

If phosphoric acid or mineral phosphates are employed in the chemical treatment of the juice, these are recovered in

the filter-press cake, thus increasing its value. When the juice is treated with sulphur dioxide, variable percentages of calcium sulphite are found in the cake, slowly oxidising to sulphate, but of no special importance as a fertiliser. When the cakes are applied in the moist condition, the large percentage of organic matter may be beneficial to the soil. But, when the cakes are allowed to become air-dried before being carted to the fields, the cost of transport is reduced, but the contained sugar is destroyed by fermentation.

The fertilising value of carbonation-cake is mainly due to the calcium carbonate and organic matters, and its value per ton is very small compared with the cake obtained in the defecation factory.

(b) Extraction of Cane-wax

The presence of wax on the exterior of the cane-stem was referred to on p. 135. During milling, a large proportion of this wax becomes detached and mixes with the extracted juice as an insoluble suspended impurity (p. 128); the remainder of the wax being left in the bagasse (p. 351). On liming the juice, the precipitated non-sugars carry down the suspended particles of wax which thus pass into the sediments in the settling-tanks, and, finally, into the filter-press cakes.

Cane-wax therefore forms part of the "organic matters" in the cake, recorded in Table XIV. The wax is insoluble in cold water and alcohol, but readily soluble in hot alcohol, benzene, ether, chloroform, petroleum, and similar solvents. On heating dried filter-press cake with benzene, from 9 to 17% of waxy matter is extracted, according to the variety of cane. The dried cake obtained from the Uba cane (grown in Natal) yields from 14 to 17%, and that obtained from the seedling-canes D. 74 and D. 109 yields about 16% of matters soluble in benzene.

Wijnberg states that the material thus extracted contains only 30% of true cane-wax, mixed with 70% of fatty matter (glycerides of various acids); the true wax having a high melting point (82°–88° C.), whilst that of the mixture is very much lower. He concludes that cane-wax could be sub-

stituted for carnauba wax for various purposes. Specimens of cane-wax extracted in Hawaii were submitted to the late Dr. Lewkowitsch, who estimated the commercial value at not more than $2\frac{1}{2}d.$ per pound; other estimates being from $3d.$ to $4d.$ per pound.

The wax is now being extracted commercially from filter-press cake in Natal. The cake is first carefully dried, crushed to a powder, and heated with a suitable quantity of benzene. After subsidation and decantation, the hot benzene-extract is filtered and allowed to cool, when the wax separates from the solution and is recovered by a second filtration. This crude wax is very dark in colour and requires to be purified, which is a costly process. Dried cake containing 17% of matters soluble in benzene may yield only about half this quantity of purified wax. Clacher claims that a purer wax is extracted from the filter-press cake by substituting paraffin for benzene.

Cross recommends the extraction of the wax from the raw juice before liming or sulphitation, by treating the juice in centrifugal-subsiders (p. 223). The suspended solid matters (including the wax) are deposited in the drum, instead of passing into the filter-presses. The wax could be extracted from the centrifugal-deposit by boiling with denatured alcohol, filtering, and cooling. Browne has extracted the wax from the precipitate obtained by sulphitation of the raw juice before the addition of lime-cream. In this case, also, the precipitate would have to be separated in centrifugal-subsiders as it is too gelatinous to separate by filtration through cloth. In either of these methods, the whole of the wax would be separated from the juice together with a relatively small quantity of other solid matters, so that the cost of extracting the wax would be much lower than when the bulky filter-press cake has to be treated. The extracted wax would also contain less fatty matters, and consequently be of higher market-value.

(c) *Carbonised Filter-press Cake as Decolourising Agent for Syrup*

Experiments by Hazewinkel in Java indicate that carbonised filter-press cake removes about one-third of the

colour from cane syrup; the practical application of this process is now being studied.

(3) FINAL MOLASSES

About 3 tons of molasses are produced per 100 tons of cane, equivalent to about 20 to 30 tons of molasses per 100 tons of commercial sugar made. The world's annual production of cane molasses averaged $1\frac{1}{2}$ million tons, or about 230 million gallons, during the years 1910-14.

The approximate percentages of the more important constituents are given in Table XV.

TABLE XV.—COMPOSITION OF CANE MOLASSES

	<i>Per cent. on Molasses.</i>	<i>Per cent. on Ash.</i>
Water	20.0	—
Organic matter {	Sucrose	—
	Reducing sugars	—
	Non-sugars	—
Nitrogen	0.1 to 0.5	—
Mineral matter { or Ash	Potash (K_2O)	35.0 to 52.0
	Phosphoric acid (P_2O_5)	1.2 ,, 2.4
	Lime (CaO)	6.2 ,, 18.0
7.0% to 10.0%	0.5 ,, 1.5	

The various methods of utilising molasses are shown in Scheme 1 on opposite page.

It will be observed that the by-products obtained from the manufacture of alcohol, from molasses used as fuel, and the dung from stock fed on molasses, all contain the mineral matters present in the original molasses, and are therefore available as fertilisers on the cane-fields. On the other hand, when molasses is applied directly to the soil, the carbohydrates are lost by decomposition, and only the mineral constituents utilised.

If the local cane-fields do not require potash fertiliser, potash may be extracted from the raw molasses, or from the by-product obtained in the manufacture of alcohol, and sold. In countries where there is little local demand for alcohol and where shipping-freights are excessive, the carbohydrates may be converted into cattle-food for export, or the molasses may be boiled down and "solidified" for export and converted into alcohol in another country.

(a) *Production of Alcohol*

The action of yeast on sucrose was described on p. 113. Taking 34.0 as the average percentage of sucrose in molasses, this would yield $\frac{34 \times 100}{95} = 36$ of invert sugar, and taking 22.0 as the average percentage of reducing sugars, gives 58% of total fermentable sugars (expressed as invert sugar). The theoretical yield of pure alcohol will be:—

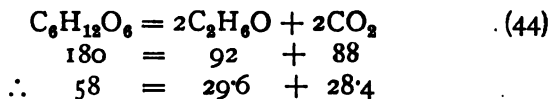

The practical yield is only about 83%, or $\frac{29.6 \times 83}{100} = 24.6$ tons of pure alcohol per 100 tons of molasses. The specific gravity of pure alcohol being 0.7938, and that of molasses about 1.450, 1 gallon of absolute alcohol should be obtained from $\frac{100 \times 0.7938}{24.6 \times 1.45} = 2.3$ gallons of molasses.

Preparation of the "Wort."—As the growth of yeast is retarded by the presence of alcohol formed during fermentation, the molasses must be diluted sufficiently to ensure rapid and complete fermentation, a suitable density being 1.060. The dilution is sometimes carried out in the fermenting-vats, but is preferably done in a mechanical mixer whence the diluted molasses is pumped to the vats. Rapid growth of the yeast is ensured by the addition of *yeast-food* in the form of 10 pounds of ammonium sulphate per 1000 gallons of diluted molasses. To retard the development of certain bacteria which decompose sugars without formation of alcohol, the above mixture is acidified by the addition of 1 gallon of sulphuric acid per 1000 gallons. These additions increase the density to about 1.063. The liquid is now called *wort* (or *wash* in the West Indies), and its preparation is termed *setting up the wort*. The word *wash* is more correctly applied to the fermented wort as it passes to the distilling apparatus. Other methods of preparing the *wort* are employed in Jamaica, but need not be described here.

Fermentation.—The yeast present in the atmosphere, or adhering to the interior surfaces of the vats, is sufficient to start fermentation without addition of yeast; the yeast-cells multiplying very rapidly. The fermenting wort becomes warm, and the active evolution of carbon dioxide gas produces a thick, white foam on the surface. The period required for fermentation varies with the composition and acidity of the wash, the variety of yeast used, and whether open or closed vats are employed. With wort prepared as above, fermentation is complete in two or three days, the foam then disappears, and the density of the wash is reduced to about 1.010 by the conversion of sugars into alcohol.

The fall in density, called the *attenuation*, would be $1.063 - 1.010 = 0.053$. This, multiplied by 1000, gives 53 *degrees of attenuation*, and every 5 degrees indicates 1.06 gallons of proof-spirit produced per 100 gallons of wash. In the above example, 53 degrees of attenuation indicate $\frac{53 \times 1.06}{5} = 11.24$ gallons of proof-spirit per 100 gallons of fermented wash; and, as proof-spirit contains 57% of pure alcohol by volume, $\frac{11.24 \times 57}{100} = 6.4$ gallons of absolute alcohol in 100 gallons of fermented wash.

Proof-spirit has a density of 0.9198, and contains 49.24% absolute alcohol by weight, and 57% by volume. A spirit is called 30 *over-proof* (30 O.P.) when its alcoholic strength is such that 100 volumes mixed with 30 volumes of water produce 130 volumes of proof-spirit. Similarly, a spirit is called 30 *under-proof* (30 U.P.) when 100 volumes contain $100 - 30 = 70$ volumes of proof-spirit (*i. e.* 100 volumes of 30 U.P. contain 70 volumes of proof-spirit + 30 volumes of water). American proof-spirit contains 50% absolute alcohol by volume.

Distillation.—Two types of distilling apparatus are used—*pot stills*, which operate intermittently, and *continuous stills*.

(a) *The Pot Still.*—As a single distillation would yield a very dilute spirit, it is essential to combine distillation with a rectifying process in which the steam evolved from the boiling wash is condensed, whilst the alcoholic vapours escape

from the *rectifier* and are condensed elsewhere. The pot still usually comprises the following parts:—

- (1) A *large retort* or pot, containing the fermented wash, and heated by an internal steam-coil. The pot may be of metal (Fig. 35) or constructed of wood. The vapour from the boiling wash escapes through a bent copper vapour-pipe (goose-neck), the lower extremity of this pipe dipping into the liquid contained in (2).
- (2) A *small retort* or pot, containing weak spirit collected from the previous distillation, and heated by the vapour escaping from (1). It acts as a rectifier to the vapour leaving (1) by condensing a large proportion of the steam, but allows the alcohol-vapour to pass on to (3).
- (3) The *Rectifier* proper is a vertical tubular vessel, mounted above (2) but not shown in Fig. 35. The vapour escaping from (2) passes upwards through the vertical tubes which are cooled externally by a current of water flowing through the outer jacket. Here a considerable quantity of water-vapour is condensed and flows back into (2), whilst the uncondensed and strongly alcoholic vapour passes on to (4).
- (4) The *Condenser* is a spiral tube, or worm, immersed in a vessel through which cold water flows, the temperature of the worm being sufficiently low to condense the whole of the alcohol-vapour entering from (3).

A simpler arrangement is shown in Fig. 35. Sometimes, a third retort or pot is substituted for the tubular rectifier (3).

When in action, spirit of about 54 O.P. strength flows from the condenser, but the strength gradually decreases in proportion as the wash in the large pot becomes deprived of alcohol. When the spirit-strength falls to about 42 O.P. the receiver is changed so that all weaker spirit is collected separately. All above 42 O.P. strength is termed *high-wines*, and below that limit, *low-wines*. Distillation is con-

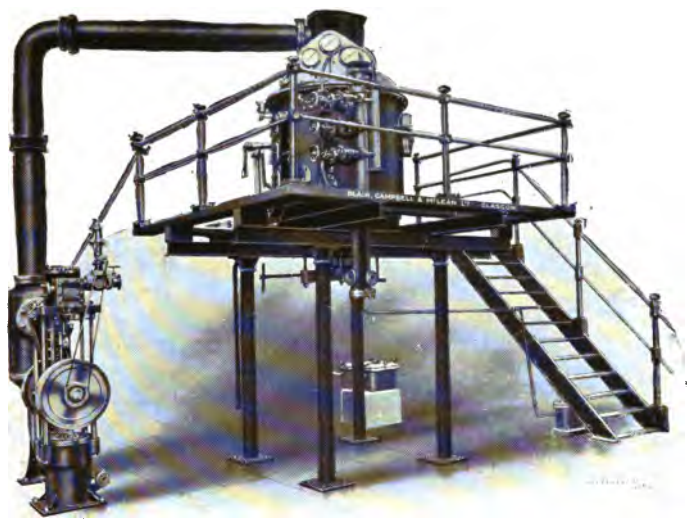
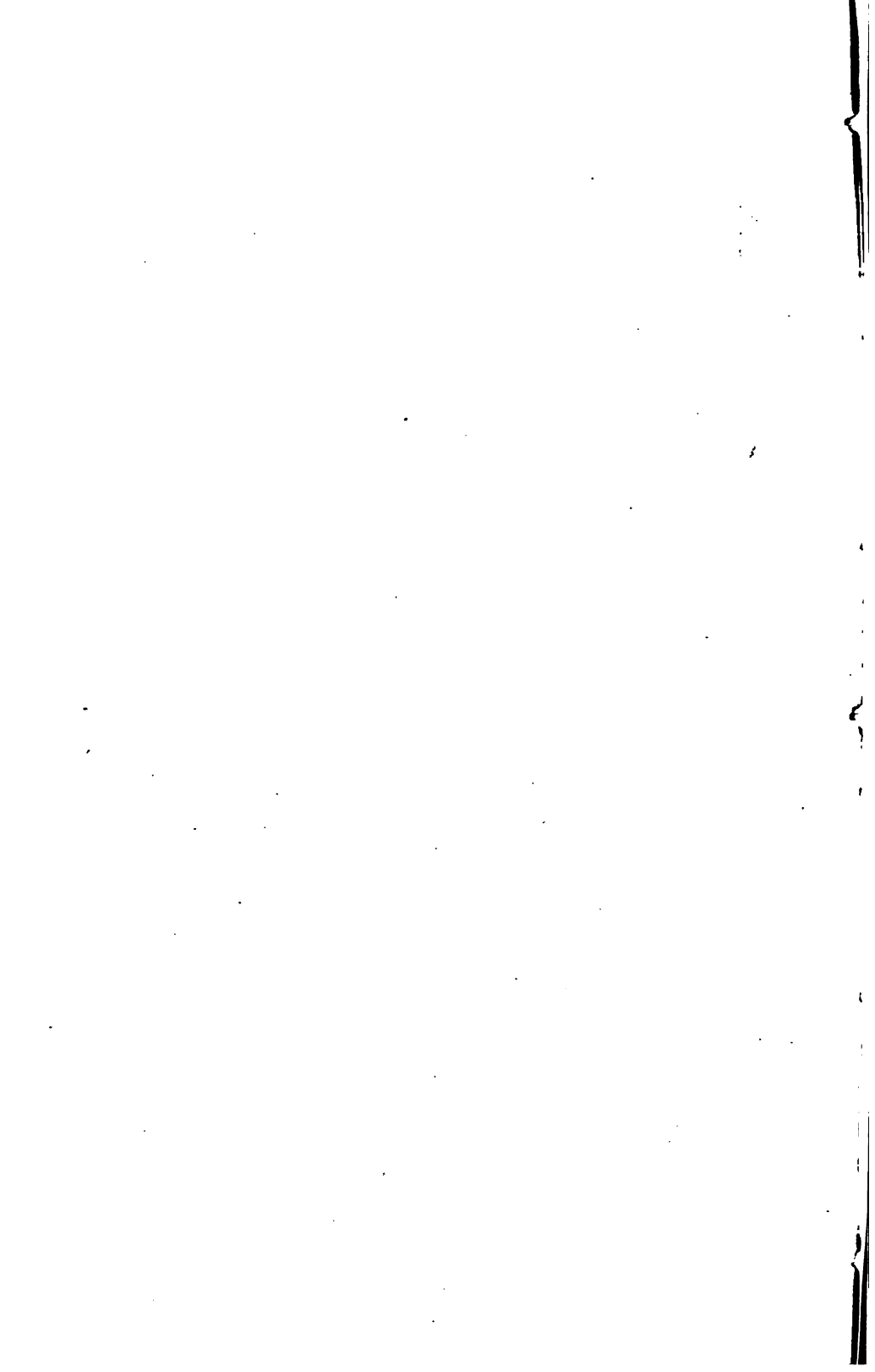

FIG. 29. VACUUM PAN, WITH CONDENSER AND PUMP, (See p. 265)



FIG. 35. POT STILL, WITH RETORT AND CONDENSER.
(Messrs. Blair, Campbell & McLean, Ltd., Glasgow.)



tinued until the *low-wines* are greatly reduced in alcoholic strength, corresponding to the complete removal of alcohol from the large retort or pot. The two retorts are then emptied, the large retort is re-charged with fermented wash, the *low-wines* (obtained above) placed in the small pot, and the distilling process repeated. The *low-wines* from each distillation are thus re-distilled and produce *high-wines* in the following distillation. As the fermented wash has to be heated to boiling point before distillation begins, the fuel consumption amounts to about 9 cwt. of coal per 100 gallons of 42 O.P. spirit.

(b) *The Continuous Still*.—The “Coffey Still” is shown in Fig. 36, and consists of two tall, vertical columns composed of horizontal frames, placed one upon another, and separated by perforated copper trays, with water-tight joints between the frames. The wash is vapourised in the right-hand column (the *Analyser*) and the resulting vapour is rectified in the second column (the *Rectifier*). The wash is boiled during its downward motion from the top to the bottom of the *Analyser*, by flowing over the upper surfaces of the copper plates and gravitating from plate to plate by means of short dip-pipes placed at alternate ends of the plates. Steam enters at the bottom of the *Analyser*, passes upwards through the small perforations in the plates and through the shallow layer of wash on each plate, evaporating the alcohol, and itself becoming condensed. The alcohol-vapour, mixed with steam, ascends towards the top of the *Analyser*, whilst the wash becomes completely deprived of alcohol when it reaches the bottom of the *Analyser*, from which it flows in a continuous stream.

The alcohol-vapour is led from the top of the *Analyser* to the bottom of the *Rectifier* by an external connecting-pipe. Whereas the *Analyser* is heated from the bottom upwards, the *Rectifier* is cooled from the top downwards, and the cooling agent employed is the wash itself, during its passage from the fermentation-vats to the *Analyser*. The cold wash flows through a continuous pipe which is repeatedly bent on itself, forming a series of horizontal *serpentes* inside the frames composing the *Rectifier*. As the wash

descends and the alcohol-vapour ascends through the *Rectifier*, the wash is gradually heated, and the ascending vapours are gradually cooled.

The wash thus attains a temperature of about 200° F. before it passes to the top of the *Analyser* and flows over the copper plates, as explained above. The wash therefore flows continuously through the two towers, acting first as a condensing agent in the *Rectifier*, then undergoing distillation in the *Analyser*, and finally escaping from the latter as "spent wash," free from alcohol.

The vapour passing from the top of the *Analyser* to the bottom of the *Rectifier* has a temperature of about 210° F. As it ascends through the *Rectifier* its temperature falls and water-vapour is condensed upon the serpentine through which the wash is flowing. This condensed portion flows downwards over the lower perforated copper plates (as in the *Analyser*), whilst the uncondensed vapour continues to ascend through the upper perforated plates, more water being condensed as the temperature decreases.

At a certain height in the *Rectifier*, the alcoholic vapour attains the desired strength (48 O.P.), and, at this point, the tower is divided horizontally by a non-perforated plate called the "spirit plate." This has an opening to allow vapour to pass upwards, but whatever condenses above this plate is drawn off through a side-pipe which projects horizontally from the spirit-plate and leads to a condensing-worm, or *refrigerator*, where the spirit is thoroughly cooled before entering the storage-vat.

By utilising the alcoholic vapours for heating the wash, the consumption of fuel is reduced to about 6 cwt. of coal per 100 gallons of 48 O.P. spirit. Further particulars of the Coffey Still, and of other continuous stills, will be found in Scard and Jones' *The Manufacture of Cane Sugar*, pp. 421-34.

The various purposes to which alcohol can be put, and the various by-products obtained in its manufacture, are shown in Scheme 2 opposite p. 356. They will be referred to very briefly.

(a) *Rum*.—This is distilled spirit of about 40 O.P. strength,

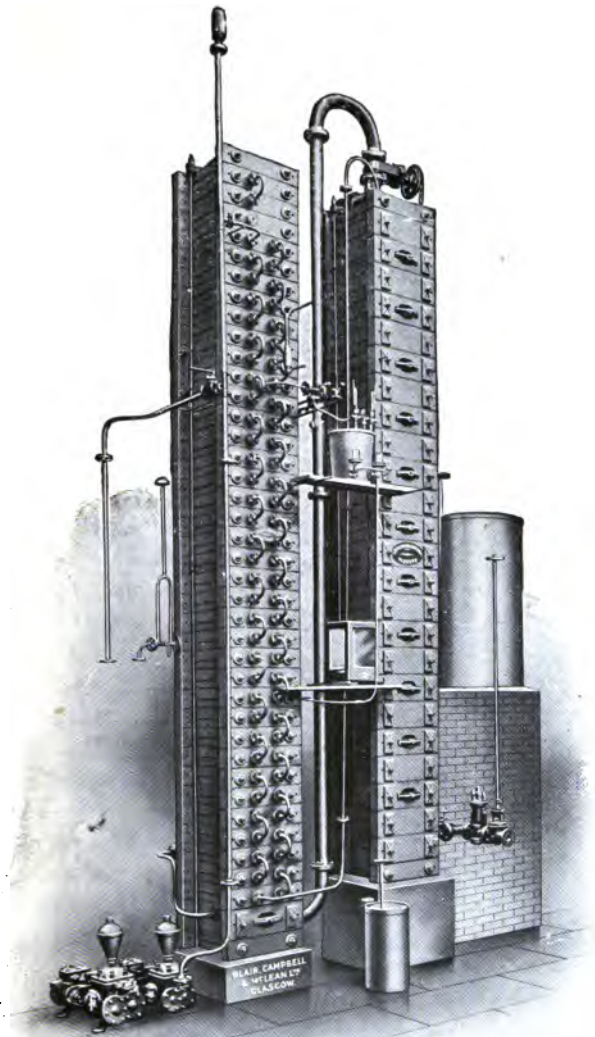
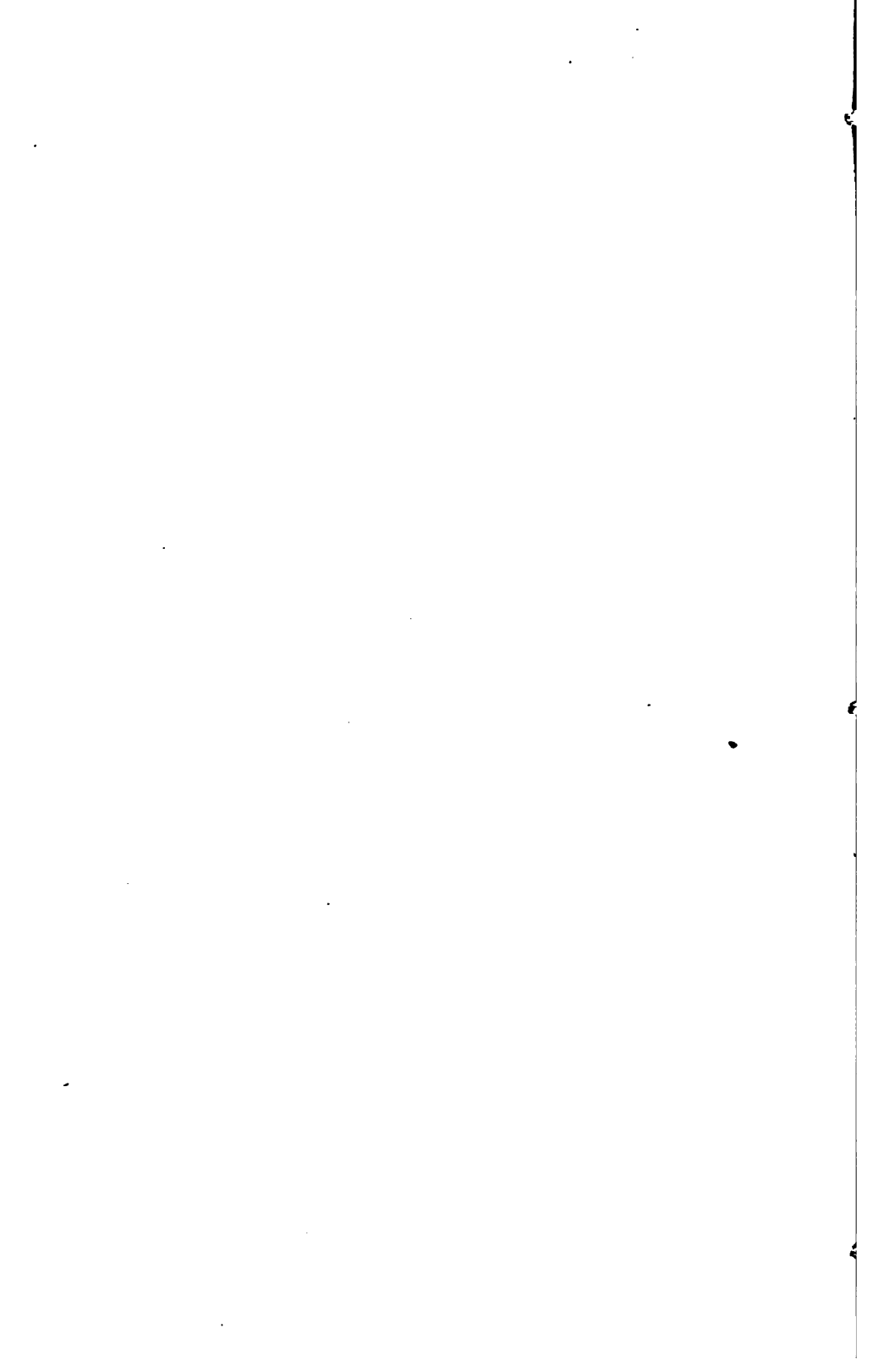

FIG. 36. COFFEY'S CONTINUOUS STILL.



but is diluted with water before it reaches the consumer. It is quite colourless when distilled, but an alcoholic solution of caramel (prepared from burnt sugar) is added. The flavour is due to small quantities of acetic, butyric, and propionic ethers, which are formed in the wash during fermentation, and separated from it by distillation.

(b) *Denatured Alcohol*.—The distilled spirit is rendered undrinkable by suitable additions of wood-spirit, benzene, pyridine, etc. In districts where coal-gas is not available for domestic purposes, cheap alcohol has many advantages over oil for heating and lighting rooms and for cooking. Denatured alcohol is used in numerous manufactures; such as varnishes, polishes, enamels, celluloid, aniline colours, dyeing operations, collodion, transparent soap, sulphuric ether, chloral hydrate, chloroform, artificial silk, explosives, photographic emulsions, vinegar, etc. For these industries, Germany used nearly 32 million gallons of denatured alcohol in 1904-5.

In recent years, alcohol has been substituted for petrol for internal-combustion engines, either alone, or mixed with benzene in order to increase its calorific value. A mixture of 60 parts of 97% alcohol and 40 parts of ether, known as *Natalite*, is being manufactured from cane-molasses in Natal. The factory erected for this purpose produces 3000 gallons of 97% alcohol per day, and produced over 255,000 gallons of *Natalite* in 1918; 1 gallon being obtained from about 3 gallons of molasses. The same factory also produces methylated spirit, chloroform, and fusel oil for the market.

Natalite has been tested by the Royal Automobile Club, giving an efficiency of 26·2 ton-miles per gallon. It was also tested by Prof. V. B. Lewes, who reported that at a speed of 1300 revolutions per minute, 1·17 gallons of *Natalite* gave the same efficiency as 1 gallon of Pratt's *Perfection Petrol*, and would be superior to the latter when the pressure in the cylinder is increased to about 160 pounds. The products of combustion of *Natalite* have no offensive odour, do not corrode the cylinder, and leave no deposit.

(c) *Acetic Acid and Acetone*.—Molasses-wort is fermented by yeast, and the resulting alcohol converted into acetic acid by inoculating the wash with suitable bacteria. The acetic

acid is then separated by distillation, neutralised with lime, and the solution of calcium acetate evaporated to dryness. The dry acetate can either be sold, or converted into commercial acetic acid by distillation with sulphuric acid.

The demand for acetone in the manufacture of cordite during the war led the Australian Government to erect a factory for the manufacture of acetate of lime from cane molasses in Queensland, with subsequent production of acetone by dry distillation. In Fernbach's process for producing acetone by fermentation, the molasses-wort is inoculated with *Bacillus acetoethylicum*. The sugar present in the wort yields 22.4% of alcohol, and 9.0% of acetone, which can be separated.

(d) *Yeast*.—In the manufacture of rum, the yeast deposits as a sludge at the bottom of the fermenting vats and is usually run to waste, thereby losing a considerable volume of admixed fermented wash. Centrifugal-subsiders (p. 223) could be used for separating the yeast in a semi-solid state for use as cattle-food, or as fertiliser. Human food, closely resembling malt-extract, is manufactured from yeast by chemical treatment (see under "Yeast from Beet Molasses" in following chapter).

(e) *Carbon Dioxide Gas*.—By employing closed fermenting vats, the carbon dioxide can be collected and compressed into steel cylinders for sale. This plan is adopted at the molasses-distilleries owned by the Colonial Sugar Refining Co. of Australia, and the gas is sold to manufacturers of aerated waters.

(f) *Fusel Oil*.—Alcoholic fermentation yields small quantities of other alcohols, having much higher boiling points than the chief product—ethyl alcohol. These higher alcohols are collectively termed *fusel oil*, although that name properly refers to amyl alcohol, $C_5H_{11}OH$, with boiling point $270^\circ F$. These higher alcohols are only partially separated from the ethyl alcohol during distillation and rectification, and collect in the "*hot-feints*" of the rectifying apparatus, whence they can be extracted by re-distillation and rectification.

(g) *Glycerin or Glycerol* is a trihydric alcohol— $C_3H_5(OH)_3$ —and is formed during alcoholic fermentation in the proportion of 2 to 3 parts by weight on 100 parts of fermented

sugars. Glycerin is mainly produced from fats and from the by-product of the soap industry. The urgent demand for glycerin during the war, and the scarcity of fats in Germany, led to attempts to produce glycerin from fermented molasses. Germany appears to have solved this problem, but the details have not been made known.

Experiments made by the U.S. Bureau of Internal Revenue gave satisfactory results by the following process. Low-grade cane-molasses was diluted with water to a density of 1.088, sterilised, and inoculated with a pure culture of a special yeast (*Saccharomyces ellipsoideus*). During fermentation, soda-ash was gradually added in the proportion of 5 grams per 100 c.c. After fermentation, the wash contained 3.1% glycerin, 6.75% alcohol (by volume), and 0.86% of unfermented sugar. As the original wort contained 16.8% sugar, the yield of glycerin was $\frac{3.1 \times 100}{16} = 19.4\%$ of sugar fermented. This was increased to 25% under favourable conditions.

The alcohol was recovered by distillation in the usual manner, after which the glycerin was separated from the *spent wash* by steam-distillation under reduced pressure. But, in the latter operation, only about 50% of the glycerin actually present could be recovered, or a yield of 9.7% of sugar fermented. The distilled glycerin was concentrated to a density of 1.2616, and used in the manufacture of dynamite. The investigations are still in progress, and higher yields may be obtained.

(See also Extraction of Glycerin from Beet-vinasse, p. 381.)

(b) *Molasses as Fuel*

As molasses is rarely burnt alone, but with bagasse, its fuel-efficiency has not been fully studied, but is assumed to be equal to that of moist bagasse. The general method of burning molasses is to sprinkle it over the bagasse when the latter leaves the mill, or immediately before it enters the furnace. Another method is to spray the molasses into the combustion-chamber of the bagasse-furnace by means of a steam-injector.

When directly mixed with the bagasse, a large volume of coke is produced, which covers the grate-area of the furnace and retards the entrance of air required for combustion. When this coke attains the maximum temperature in the furnace, the potash and lime in the molasses combine with the silica in the bagasse, forming a fused slag or glass which adheres to the grate-bars, causing obstruction to the entering air and necessitating much manual labour to remove it periodically. The slag is of no value as a fertiliser because the contained potash is insoluble.

Special furnaces have been designed and used for burning molasses alone, the ash being then unfused and containing from 30 to 50% of potash. This ash can be used as fertiliser, or leached with water to extract the potash, which is purified by crystallisation and sold (see Scheme I opposite p. 356).

The gross calorific value of molasses has been rarely determined in the bomb-calorimeter, but two recorded experiments give the values 6956 and 6840 B.T.U. per pound of dry matter. Taking the mean of these, the gross calorific value of fluid molasses (20% water) would be $\frac{6900 \times 80}{100} = 5520$ B.T.U. per pound, or 1200 B.T.U. in excess of the gross calorific value of bagasse (48% water), as calculated on p. 346. As molasses contains less water, less heat is lost by water-vapour passing into the chimney than in the case of bagasse, thereby increasing the *available heat* of molasses-fuel.

(c) *Molasses as Fertiliser*

(1) *Raw Molasses*.—Molasses contains about 50% of the total mineral matters, and about 75% of the total potash in the cane; the balance being left in the bagasse, filter-press cakes, and raw sugars. These mineral matters having been removed from the soil, should be returned to it in order to maintain its fertility and to minimise the expenditure on commercial fertilisers. The use of bagasse-ashes and filter-press cake as fertilisers has already been referred to. The fertilising value of molasses is mainly due to potash, but the large percentage of organic matter (including sugars) may

improve the physical texture of certain soils, and increase the activity of soil-bacteria. The direct application of molasses to the soil involves complete loss of the contained sugars, and their decomposition gives rise to acid products, which, if allowed to accumulate, may render the soil "sour" and impair instead of improve its fertility.

The effect of molasses on the heavy clay soils of B. Guiana was studied by Harrison and Ward in 1911-12, with the following results:—"On plots which received no other fertiliser, the application of molasses was detrimental. On plots fertilised with phosphates, potash, and sulphate of ammonia, the addition of molasses had no effect. On plots fertilised with sulphate of ammonia alone, or with a mixture of phosphates, potash, and nitrate of soda, the application of molasses gave a slight increase, not exceeding the probable experimental error. Doubling and trebling the quantity of molasses applied per acre gave no appreciable increase in yield of canes."

Ebbles claims that the satisfactory results of molasses-manuring in Mauritius is due to its application three or four months before the cane-tops are planted, the molasses being poured into the holes prepared to receive the tops, in the proportion of about 4 tons of molasses per acre.

Bonâme's experiments in Mauritius gave an increase of 12 tons of cane per acre by addition of molasses, relative to other fertilisers containing no potash; an increase of 11 tons of cane per acre, relative to other fertilisers containing no nitrogen; an increase of 10 tons of cane per acre, relative to other fertilisers containing potash, nitrogen, and phosphoric acid; an increase of only 2 tons of cane per acre when no other fertiliser was added; and an average increase of 8 tons of cane per acre in the whole series of experiments. He states that the effect of molasses is very marked in the case of plant-canes, but some benefit is also found in the subsequent ratoon crops; and the advantage of molasses-manuring was most noticeable on plots which received no other form of potash and nitrogen.

Similar experiments were carried out in Java during 1911-12, the molasses being applied at the rate of 10 tons per acre,

one month before planting, and in addition to the normal application of sulphate of ammonia. The addition of molasses gave an increased yield of about 12 tons of cane per acre, a slight increase in yield of sugar per acre (within the limits of experimental error), and a decrease in percentage of *available sugar* in juice. On substituting an equivalent weight of crystallised sugar for the sugar present in fluid molasses, the yield of canes was increased by about 6 tons per acre, relative to the yield with sulphate of ammonia alone. This last result has been explained on the assumption that the decomposition of sugar in the soil favours the growth and multiplication of those soil-bacteria which convert ammonia into nitrates, and thus provide the growing cane-plant with nitrogen. Laboratory experiments have so far failed to confirm this theory.

(2) *Carbonised Molasses*.—The potash and other mineral constituents of molasses can be returned to the soil in a much more concentrated form by heating the molasses, thus evaporating the contained water and destroying the organic matter more or less completely. By varying the degree of carbonisation, the final product may contain the total mineral matter and various percentages of organic carbonaceous matter, forming a black powdery material which is easily transported and applied in the field, or may be mixed with other fertilisers if desired. Complete combustion occurs when the molasses is used as fuel in special furnaces, the resulting ashes containing the whole of the mineral matter entirely free from organic matter. If the local soils contain sufficient available-potash, it might be profitable to convert all surplus molasses into ash, to be sold as crude potash, or to extract the potash from it and market the purified product.

(3) *Spent-wash from the Molasses-distillery* (see Scheme 1, opposite p. 356).—In this case, the sugars have been converted into alcohol, leaving the mineral constituents of the molasses in the wash, which contains about 90·5% of water, 9·5% of total dry solid matter, including about 1·4% of potash, about 0·1% nitrogen, and 0·05% phosphoric acid. On irrigated estates, this liquid can be distributed over the cane-fields at no cost whatever, but in this very dilute form its fertilising value is very doubtful.

It may be concentrated to a thick fluid in a multiple-effect evaporator and applied in that form, or mixed with some absorbent, such as peat. Or the concentrated fluid can be treated with sulphuric acid to carbonise the organic matters, and evaporated to dryness, yielding a powdery product which is easily handled and can be stored in bags for use as fertiliser on the estate, or the potash can be extracted as crystals and sold. The yeast-sediments from the fermenting-vats can be concentrated and carbonised in the same manner, in order to recover the nitrogen and phosphoric acid contained in the yeast, and abstracted from the fermenting wash.

Deerr and Peck suggest treating the spent-wash with lime to precipitate the nitrogenous constituents. They ascertained that about 60% of the total nitrogen is precipitated by the addition of 150 pounds of quicklime per 1000 gallons of wash. The precipitate can be readily removed by filter-pressing, yielding a cake containing about 50% water and 1.9% of actual nitrogen, but the whole of the potash remains in solution in the filtrate, and is lost.

(4) *Dung from Stock fed on Molasses* (see Scheme 1, opposite p. 356).—In this case, the carbohydrates and nitrogen in molasses are converted into muscular energy for transporting canes, etc. on the estate, and the mineral constituents are recovered in the dung, mixed with various organic matters, and ready for application as fertiliser.

(d) *Molasses as Cattle-food*

As only a small proportion of the molasses produced can be fed to stock on the estate, a commercial molasses-food is now manufactured for export under the name of "*Molascuit*." It is produced by absorbing about 80 parts of hot molasses in 20 parts of dried and sifted bagasse-pith, this pith being partly digestible. The mixture is a dark brown meal, which can be shipped in bags. The machinery used in its manufacture is described and illustrated in Scard & Jones' *Manufacture of Cane Sugar*, pp. 439-45. "Colco" molasses-food is prepared by mixing 60 parts of cane-molasses with 40 parts of ground rice-husks. "Molassine" is a similar mixture containing 70 to 75% of molasses (cane or beet) and 25 to 30

parts of dried sphagnum moss. The composition of these foods is shown below.

TABLE XVI.—COMPOSITION OF MOLASSES CATTLE-FOODS

	<i>Molascuit.</i>	<i>Colco.</i>	<i>Molassine.</i>
Sugar and other carbohydrates	57.6	57.4	58.8
Digestible cellulose	13.2	} 12.8	} 6.2
Indigestible cellulose	5.9		
Albuminoids	2.3	3.9	8.9
Oil	0.2	1.7	0.4
Ash	6.7	11.7	7.7
Moisture	14.1	12.5	18.0
	100.0	100.0	100.0

(e) *Solidified Molasses*

When molasses cannot be completely utilised by the methods described above, it may be concentrated to a solid state for export to other countries. Thus, Java exported 59,221 tons of solidified molasses to British India in 1911, 76,718 tons in 1912, and 66,809 tons in 1913.

Before concentration, the molasses is purified by injecting steam through perforated pipes and separating the scum which rises to the surface. The molasses is then boiled in a vacuum pan under a high vacuum until a proof-stick sample, cooled in water, becomes quite brittle. To avoid loss by foaming, the pan is filled to about three-quarters of its working capacity. When the desired concentration is reached, steam is shut off and cold water circulated through the steam-coils; the vacuum being maintained in order to remove the final portions of water, also any gases which may be evolved by decomposition of reducing sugars. The water-circulation through the steam-coils is continued until the contents of pan have cooled to about 60° C. The air-pump is then stopped, air admitted to pan, and the discharge-door opened. The still hot material flows quite slowly from the pan and is received in bamboo baskets lined with palm-leaf mats. The contents of the baskets are stirred during cooling to assist the escape of gases, and are finally covered with palm-leaf mats and lids.

For convenience in handling, each basket contains about 200 pounds, but other sizes can be adopted. After complete cooling, the molasses forms a hard block containing about 0·2% moisture, and of 44·4 polarisation, and 39 purity. On arriving at their destination the blocks are broken up by machinery, dissolved in hot water, and the solution diluted to the desired density. If employed in the production of alcohol, 100 pounds of solid molasses yield from 6·3 to 7 gallons of proof-spirit.

(f) Decolourising-carbon from Molasses

Peck and Adams have produced a highly efficient decolourising-carbon by treating a mixture of cane-molasses and kieselguhr with sulphuric acid, carbonising at a suitable temperature in closed vessels, and washing the resulting carbon free from acid.

When freshly made, this product removes 95% of the colour from clarified cane-juice, and about 60% of the colour after the carbon has been repeatedly used. The most satisfactory method is to filter the juice through several layers of the carbon held between filter-cloths in a filter-press of special construction. The carbon absorbs other non-sugars besides colouring matters, the increase in purity of the juice before and after treatment being sometimes as high as 2·4, and sometimes only 1·2. The newly prepared dry carbon contains 30% of ash, which increases to 60% after being repeatedly used; thus proving the absorption of mineral matter from the juice. Small-scale experiments in a double-effect evaporator showed that no scale was formed on the heating-surface when the treated juice was concentrated to a thick syrup.

CHAPTER XXX

BY-PRODUCTS OF THE BEET-SUGAR FACTORY

FROM 100 tons of beets entering the factory there are obtained :—

- | | | |
|---|---|--|
| (1) Beet pulp | } | <p>About 100 tons wet pulp (95% water) discharged from diffusion battery.
 This is squeezed in Pulp-presses, and yields 40-50 tons pressed pulp (85-90% water) used as fodder for cattle.
 Or, may be further dried by heat, yielding 6 tons dried pulp (10-15% water) used as fodder.
 Or, the pressed pulp may be mixed with molasses, and dried, yielding 9 to 11 tons sweet pulp (8.5% water) used as fodder.</p> |
| (2) Filter-press Cake. | | 8 to 10 tons of wet cake (about 50% water) used as fertiliser. |
| (3) Final Molasses | } | <p>3 to 4 tons of molasses are separated from the sugar crystals, and mainly used in the production of alcohol, also as cattle-food, fertiliser, etc.
 But, when molasses is treated by the Saccharate Processes (Chapter XXVIII) to recover the contained sucrose, the residual molasses is reduced to from 1.0 to 2.0 tons on 100 of beet.
 Or, the original sweet molasses is frequently mixed with the pressed pulp and sold as cattle-food.</p> |
| (4) Waste waters resulting from the Saccharate Process of extracting sucrose from molasses. | | |

(1) BEET PULP

The approximate composition is given below :—

TABLE XVII.—COMPOSITION OF BEET PULP.

	Pressed Pulp.	Dried Pulp.	Sweet Pulp. (Steffen's Process).
Sucrose	0.8	4.5	33.0
Cellulose	2.8	16.7	11.8
Other carbohydrates	9.0	52.1	35.3
Albuminoids	1.3	7.3	7.0
Fat	0.1	0.6	0.4
Mineral matters	1.0	5.8	4.0
Water	85.0	13.0	8.5
	100.0	100.0	100.0

The first two are the by-product of the diffusion process, and only differ as regards percentage of water. The pressed pulp is sold to the beet-farmers at 4s. to 5s. per ton, in quantities proportional to the beets they deliver at the factory. The pre-war value of dried-pulp in Germany was from £4 to £5 per ton, and large quantities were purchased by the German War Office for feeding cavalry horses prior to the War. British farmers have paid £5 per ton for imported dried-pulp, and value it.

The third product—sweet pulp—is a mixture of about 100 parts of pressed-pulp and 4 to 5 parts of molasses, which is then dried by heat, and is valued at £3 10s. to £5 per ton.

The drying may be effected by means of furnace-gases or by steam. The former method is adopted in the *Büttner and Meyer Drier*, generally employed in Germany. This consists of a fire-brick chamber containing a series of open horizontal troughs, arranged one above another; each trough containing a rotating shaft with attached stirring arms, and driven by an engine outside the drying-chamber. The furnace occupies the upper portion of the drying-chamber, the gases passing downwards through a zigzag channel separating the horizontal troughs. The saturated pressed-pulp enters at one end of the uppermost troughs and is thus exposed to the full heat of the furnace-gases (500°–800° C.). So long as the pulp contains water its temperature cannot exceed 100° C., and it cannot become charred, as the stirrers keep the pulp in active motion. As drying proceeds, the density of the pulp is reduced, the lighter particles being carried forward by the hot gases, first horizontally to the opposite end of the uppermost troughs, whence they fall into the troughs below, then again horizontally until they fall into the lowermost troughs, and, finally, to an outlet at the base of the drying-chamber. The pulp and furnace-gases therefore move through the drying-chamber in the same direction; the final temperature of the gases being about 110° C., which is sufficient to prevent condensation of the water-vapour separated from the pulp. The gases are drawn through the apparatus by an exhaust-fan at the outlet.

The apparatus produces 9600 kilos. of dried-pulp per 24 hours, with a coal consumption of 8700 kilos., or 90 kilos. of coal per 100 kilos. of dried-pulp. Then, assuming that the pressed-pulp contains 88% of water, and the dried-pulp 12% water, 9600 kilos. of dried-pulp contain 8450 kilos. of dry solids derived from $\frac{8450 \times 100}{12} = 70420$ kilos. of pressed-pulp; or 1 kilo. of dried-pulp is obtained from 7.3 kilos. of pressed-pulp, or from about 14.5 kilos. of original beets.

The water evaporated in 24 hours = $70420 - 9600 = 60820$ kilos., and 1 kilo. of coal evaporates $\frac{60820}{8700} = 7.0$ kilos. of water.

The total cost of drying is about \$1.60 per 100 kilos. of dried-pulp.

When the drying-agent is steam, the horizontal troughs are provided with steam-jackets, and the stirring apparatus consists of a rotating cluster of tubes through which steam is circulated. The initial cost of this apparatus is high but the working cost is very small, since exhaust-steam from the factory can be employed as heating-agent. If direct steam be used, the fuel consumption amounts to about 80 kilos. of coal per 100 kilos. of dried pulp.

(2) FILTER-PRESS CAKE

The first carbonation and first filtration (p. 233) yield from 8 to 9 tons of cake per 100 tons of beets; this cake containing about 50% of water and from 1.5 to 2.0% of sucrose, after washing the cakes with water. The second carbonation and second filtration (p. 235) yield from 0.5 to 1 ton of cake per 100 tons of beets; this cake also containing about 50% of water and from 4.0 to 7.0% of sucrose (not washed in the press).

The composition of the water-free cake obtained from the first carbonation and first filtration is given below.

TABLE XVIII.—COMPOSITION OF FILTER-PRESS CAKE FROM BEET JUICE

		Maximum.	Minimum.
Mineral Matters.	Calcium carbonate	84·0	71·0
	Magnesium carbonate	14·2	5·7
	Calcium hydroxide	2·5	0·1
	Sand and clay	3·0	0·5
	Phosphoric acid	3·0	1·0
	Potash	0·3	0·05
Organic Matters.	Sucrose	4·0	3·0
	Fatty matters	3·5	0·5
	Other organic non-sugars	16·0	5·0
	Containing— Nitrogen	0·4	0·2

The cakes are of no value to the factory and are given *gratis* to the beet-farmer. Claassen estimated the fertilising value of the moisture-free cake at 77·5 pfennigs per 100 kilos. (equal to pre-war rate of 7*s.* 9*d.* per ton); and the cost of drying the cakes (including fuel, labour, interest, etc.) at 61 pfennigs per 100 kilos. (equal to pre-war rate of 6*s.* per ton), leaving a profit of 1*s.* 9*d.* per ton if the dried material can be sold at the price estimated.

The wet cakes discharged from the filter-presses contain about 50% of water, and are difficult to handle, costly to transport to a distance from the factory, and too moist for spreading on the surface of the soil. The cakes are frequently transported in cars to a suitable distance from the factory, and dumped in heaps as refuse.

(3) FINAL MOLASSES

The true molasses, separated in the centrifugals, represents from 3 to 4% of the weight of beets entering the factory, and from 20 to 25% on weight of sugar made. When mixed with the pressed-pulp, or treated by the Saccharate Process, the residual molasses may be less than 10% on weight of beets. The world's annual production of beet molasses averaged 1½ million tons during the years 1910-14.

The final-molasses separated in the centrifugals has the following approximate composition:—

TABLE XIX.—COMPOSITION OF BEET MOLASSES

	<i>Per cent. on Molasses.</i>	<i>Per cent. on Ash.</i>	
Water	18.0	—	
Organic matters {	Sucrose	50.0	
	Reducing Sugars	traces	
	Non-sugars	15.0	
Nitrogen	2.0	—	
Mineral Matters or Ash 8 to 12% {	Potash (K ₂ O)	3.7 to 5.0	40 to 57
	Phosphoric Acid (P ₂ O ₅)	0.1	1.0
	Lime (CaO)	0.5	5.0

The methods of utilising beet-molasses are the same as for cane-molasses (see Scheme 1, opposite p. 356), but beet-molasses is not employed as fuel.

(a) Production of Alcohol

The calculations given on p. 358 show that 50.0% of sucrose yield 52.6% of invert sugar, and a theoretical yield of 26.9% of pure alcohol. The practical yield is about 83%, or $\frac{26.9 \times 83}{100} = 22.3\%$ on weight of molasses, equal to 1 gallon of absolute alcohol from 2.5 gallons or 37 pounds of beet molasses.

The preparation of the *wort* is similar to that previously described for cane-molasses, the diluted wort containing from 16 to 18% of sugar, and special races of yeast are employed to effect fermentation. After fermentation is complete, the wash is distilled in various forms of continuous stills, yielding strong spirit containing 95% alcohol by volume. Whereas fermented cane-molasses produces a palatable spirit—rum, the distilled product from beet-molasses is only used for industrial purposes after the addition of denaturing agents (p. 363). In 1904, Germany produced 2.8 million gallons of 95% alcohol from beet-molasses out of a total production of 100 million gallons of alcohol made from potato, grain,

and other materials, and potato-spirit has been extensively used as motor-fuel for internal combustion engines.

The by-products from the beet-molasses-distillery are the same as those described in the last chapter (pp. 364-365) with certain additions which will be briefly referred to.

(a) *Yeast*.—Pressed distillery-yeast is in large demand for bread-making, and the surplus can be used as cattle-food, as fertiliser, and even as human food.

The pre-war value of pressed-yeast in Germany was £38 to £40 per ton, and the annual production was about 20,000 tons. Pressed-yeast keeps fresh for several days if the cakes are wrapped in paper and packed in cases. It can be dried at a cost of 10s. per ton, and sold as cattle-food. The wet yeast is separated from the fermented wash by filter-pressing, or by centrifugal-separators (p. 223). Aëration of the wort during fermentation diminishes the yield of alcohol and increases the yield of yeast; a still larger yield of yeast being obtained by adding nitrogen compounds to the wort.

The great scarcity of nitrogenous fodder in Germany during the war, led to the synthetical production of fodder by the following processes. The "fixation" of atmospheric nitrogen had been adopted as a source of nitrates for explosives, and this process also produced considerable quantities of ammonium salts. This ammonia was converted into protein (organic nitrogen compounds) through the agency of yeast; in other words, ammonia salts can feed yeast, and yeast can feed cattle, horses, and human beings.

The carbon-food for the yeast was supplied by sugar in beet-molasses, and a special variety of yeast was selected, producing no alcohol and multiplying twice as rapidly as distillery-yeasts. The yeast was grown in diluted molasses in fermenting-vats as large as swimming-baths; 100 parts of sucrose in the molasses yielding 76 parts by weight of dried-yeast, containing 50% of protein (derived from the added ammonium salts, or originally taken from the atmosphere). During the war, Germany produced up to 150,000 tons of pressed-yeast per annum by this process, at a cost of £12 10s. per ton. It is proposed to increase the annual

production to 300,000 tons in order to be independent of other countries for supplies of nitrogenous cattle-foods.

For use as human food, the pressed-yeast is mixed with starchy materials and baked; or is digested with a concentrated sugar solution, which is then concentrated to a thick syrup resembling malt-extract, and containing about 2.0% of protein.

It is of interest to note that yeast can consume nitrogen in the form of urea, as well as in the form of ammonium salts. Hence, the nitrogen excreted in the urine of cattle can be re-converted into protein by the agency of yeast, and used as food again; thus producing a continuous cycle, namely, protein to urea in the animal body, and urea to protein in the yeast-cells.

(b) *Vinasse, or Spent-wash.*—This by-product is obtained after the separation of alcohol by distillation and contains the whole of the potash and part of the nitrogen present in the original molasses. Its composition is given below:—

TABLE XX.—COMPOSITION OF BEET-VINASSE.

	Original Vinasse.	After Concentration to 40 Beaumé.	Composition of Dry Solid Matters.	Composition of Ash.
Specific Gravity . . .	1.0278	1.375	—	—
Brix	7°	73.7	—	—
Dry solid matters . . .	6 to 7	65.0 to 75.0	100.0	—
Ash	1.5 to 2.0	16.0 to 21.0	23.0 to 30.0	100.0
—	—	—	Betaine 10-12	Potassium carbonate 58-72
—	—	—	Glutamic acid 5-7	" chloride 11-15
—	—	—	Leucine 1-2	" sulphate 0.6-4.0
—	—	—	Fatty acids 15.0	" phosphate 0.5-1.0
Total Potash (K ₂ O)	1.0 to 1.3	10.0 to 14.0	Other substances 17.0	Sodium carbonate 6.0-15.0
Total Nitrogen . . .	0.3 to 0.5	3.0 to 5.0	14.0 to 20.0	" 6.0 to 8.0
			4.5 to 8.0	nil

In its original state it is too dilute for use as a fertiliser, but is concentrated to about 40 Beaumé (column 2 in Table) in a multiple-effect evaporator, and the resulting syrupy liquid utilised as follows.

(b 1) *As Fertiliser.*—The potash and nitrogen removed from the soil by the beet crop may thus be returned. Distribution of the vinasse is facilitated by mixing it with any absorbent material,

such as peat. A more complete fertiliser is produced by mixing 2.5 parts of vinasse-syrup with 3 parts of superphosphate, and heating the mixture to 108° C. By this treatment, gases are evolved, leaving a powdery fertiliser containing 2.25% of nitrogen, 6.33% of potash (K_2O), 11.5% of phosphoric acid (soluble in 2% citric acid), 8.5% of phosphoric acid (soluble in water), and 30.0% of organic matter.

(See also under (b 2) (b 4)).

(b 2) *Extraction of Potash.*—The vinasse-syrup is carbonised in a furnace and the resulting ashes leached with dilute alkali to extract the soluble salts. This solution is concentrated to 47° Beaumé (88° Brix) in a vacuum pan, causing potassium sulphate to crystallise from the hot solution, and potassium chloride to crystallise after cooling to 30° C. The residual mother-liquor is further concentrated to 50° Beaumé (95° Brix), when the double carbonate of potash and soda crystallises on cooling. These salts are then purified by re-crystallisation, and sold.

In the above process, the valuable nitrogen of the vinasse is lost in the furnace, and Vasseux suggests the following alternative method. The vinasse-syrup is treated with sulphuric acid, thus converting all potash salts into potassium sulphate, which crystallises during concentration of the acidified vinasse. After separation of the crystals, the mother-liquor is further concentrated to dryness, yielding a residue containing 5 to 7% of nitrogen, and 6 to 7% of potash, which can be used as a fertiliser.

(See also under (b 3)).

(b 3) *Extraction of Nitrogen.*

(a) “*Buel Process*,” yielding nitrogen in the form of sodium cyanide and ammonium sulphate, also residue of potash salts, as shown in the following scheme:—

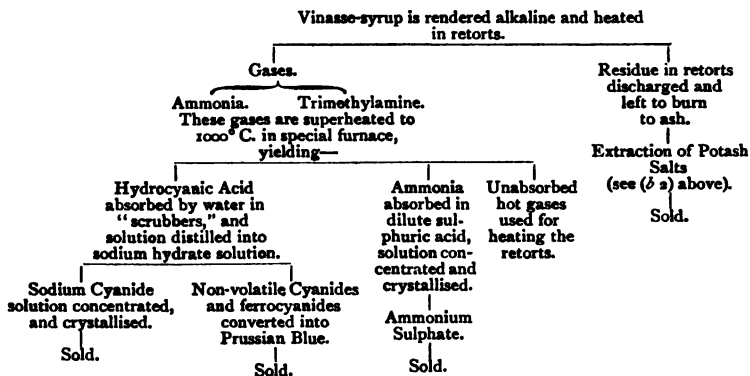

On superheating to 800°–1000° C., trimethylamine is decomposed as follows:—



and ammonia is also partially converted into hydrocyanic acid in the presence of carbon monoxide (derived from carbon in the vinasse), thus:—

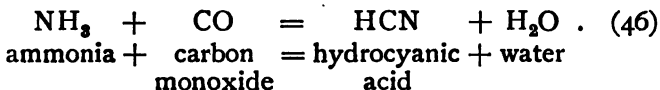

A single beet-sugar factory in Germany produced 3·5 to 4 tons of sodium cyanide daily; and, in 1907, one German firm produced potassium cyanide from beet-vinasse to the value of £80,000, and ammonium sulphate to the value of £20,000.

(b) "*Effront Process*," yielding nitrogen in the form of ammonium sulphate and extracting acetic, propionic, and butyric acids.—The original (dilute) vinasse leaving the distillery is cooled to 40°–45° C., made alkaline, and fermented with top-yeast (1 to 2 kilos. per hectolitre) for three or

four days. The yeast decomposes the amino-acids with formation of ammonia and free fatty acids, which can be separated by distillation. One hundred kilos. of molasses used in the manufacture of alcohol should yield 0.75 kilos. of ammonium sulphate, and 0.95 to 1.20 kilos. of fatty acids.

(b 4) *Extraction of Glycerin.*

(a) *Barbet's Osmosis Process.*—The vinasse-syrup is cooled and mixed with strong alcohol (96%) and the mixture dialysed in a special osmogene (p. 334). The alcoholic solution of glycerin passes through the parchment-papers into the water-cells, leaving the saline matters and other substances in the vinasse. The osmogene-water is distilled in order to recover the alcohol for use over again, and the residue in the retort is concentrated until it contains 80% of anhydrous glycerin. This may be mixed with fresh alcohol and re-treated in the osmogene, in order to obtain a purer product. The dialysed vinasse, from which the glycerin has been separated, may be used as fertiliser.

(b) *Barbet's Distillation Process.*—The vinasse-syrup is mixed with any inert powder (preferably lime and kieselguhr), the mixture dried in ovens, and crushed to a coarse powder. The glycerin is then separated by a current of hot air or steam (200°–240° C.) passed through the crushed mixture in a vacuum apparatus attached to a condenser. The distillate of crude glycerin is purified by re-distillation in a current of steam under atmospheric pressure. The residue from the first distillation can be used as fertiliser.

(b 5) *Extraction of Betaine.*—The vinasse-syrup is evaporated to dryness *in vacuo*, and the residue mixed with concentrated hydrochloric acid, whilst the temperature is maintained below 60° C. On cooling, betaine hydrochloride crystallises out.

The crystals are separated by filtration, washed with alcohol, and dried. They may be further purified by re-crystallisation from methyl alcohol, and a final re-crystallisation from water. Betaine hydrochloride is sold under the name of "acidol" for medicinal purposes.

(b) *Molasses as Fertiliser*

Beet-molasses is very rarely applied directly to the soil, since this would involve the complete loss of the contained sucrose. The latter is usually extracted by the special methods described in Chapter XXVIII, or may be converted into alcohol by fermentation, leaving the potash salts and nitrogen in the residual liquors which are then available as fertilisers, as indicated above. Or, the molasses may be fed to cattle, the sugar being thus converted into muscular energy, leaving the saline matters in the dung for application as fertiliser.

When these economic methods cannot be adopted, the raw molasses may be applied directly to the soil either in the fluid state (slightly diluted with water), or in a powdery form, obtained as follows:—

(1) Two parts of molasses are mixed with one part of slaked lime (or quicklime) forming a cake which can be crushed to a powder.

(2) The molasses may be absorbed in ground-peat, and the mixture inoculated with bacteria which decompose the contained betaine and render the mixture powdery. It then contains 25% water, 3.75% nitrogen, 9.75% potash, and 45.0% organic matter (forming "humus"). Superphosphate may be added to the mixture, until it contains 3.0% of phosphoric acid.

(c) *Molasses as Cattle-food*

(1) *Molassine Meal* (see p. 369).

(2) *Peat Meal*.—This is a mixture of 84 parts of hot molasses (60°–70° C.) and 16 parts of finely-ground and sifted peat. It contains about 42% sucrose and from 17.0 to 21.0% of water. It is completely cooled before being bagged for

transport, and will keep indefinitely. A single German beet-sugar factory produced 14,000 tons of this meal in one year.

(3) *Molasses-fodder*, adopted by the French Ministry of Munitions as a substitute for oats during the war—

Chaff or bran	40 to 50%
Ground coconut husks, or barley roots .	10 „ 20%
Molasses	40 „ 50%

The nutritive value of this fodder was valued at 580 units per kilogram as compared with 630 units for oats, and 485 units for hay.

(4) WASTE WATERS FROM SACCHARATE PROCESSES FOR EXTRACTING SUGAR FROM MOLASSES

Referring to stage (6) of Steffen's Separation Process (see p. 339), the filtrate from the tricalcium saccharate contains all the saline matters and nitrogen compounds present in the molasses treated. This filtrate is concentrated to about 55° Brix in a triple-effect evaporator, and further evaporated to dryness in a vacuum apparatus. The dry residue contains from 10 to 12% potash (K_2O) and 5% of nitrogen. Being very hygroscopic it rapidly absorbs water on exposure to the air, but this can be avoided by mixing the dry material with slaughter-house waste, forming a valuable fertiliser.

Or the dry residue may be carbonised in a furnace, yielding a white ash containing 30 to 35% of potash, from which pure potash salts may be extracted (see (b 2) on p. 379).

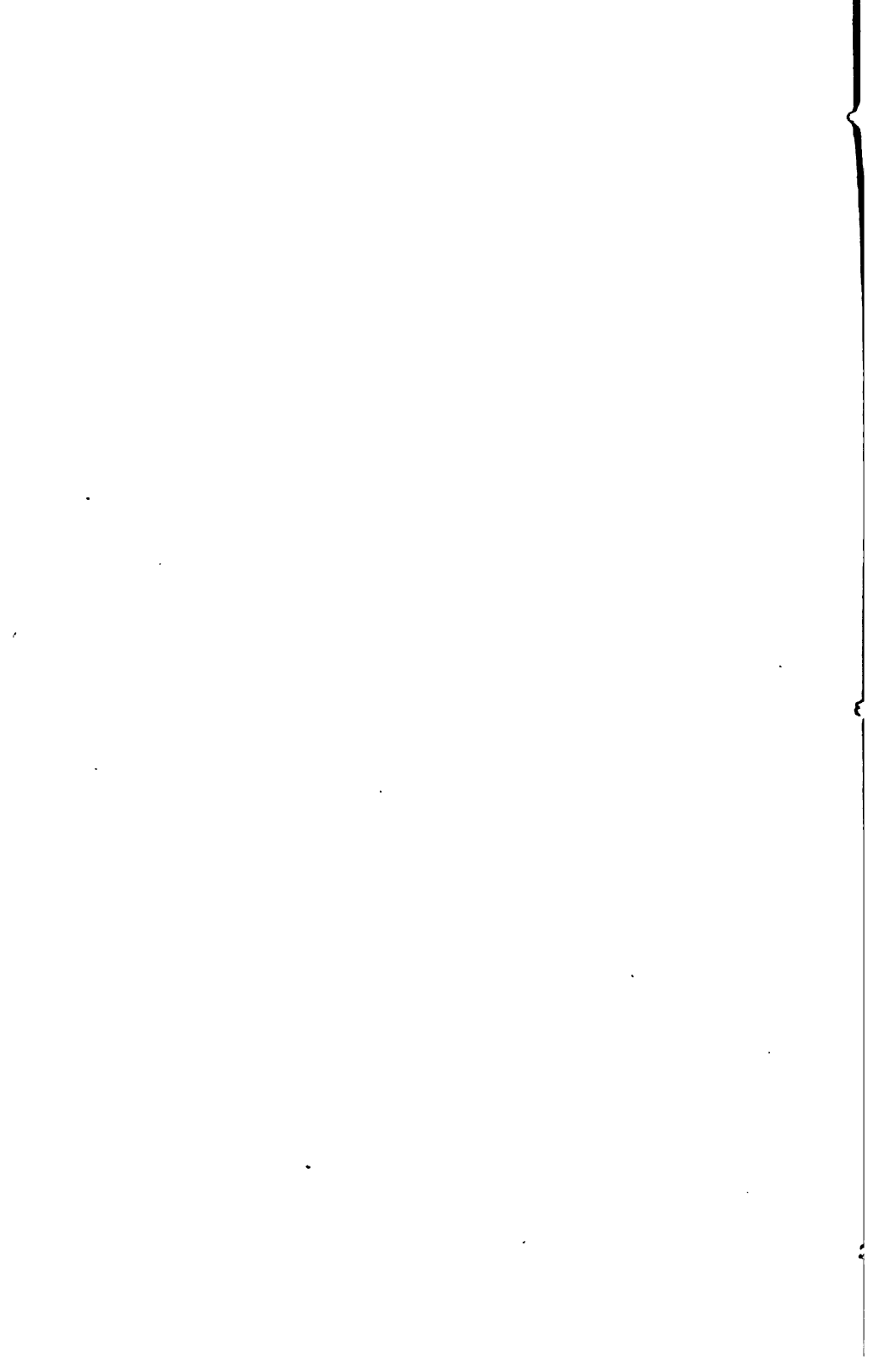

PART X

REFINING OF CANE AND BEET SUGARS

CHAPTER 31. AFFINING, MELTING, FILTERING, AND BLEACHING

„ 32. CRYSTALLISATION AND BY-PRODUCTS

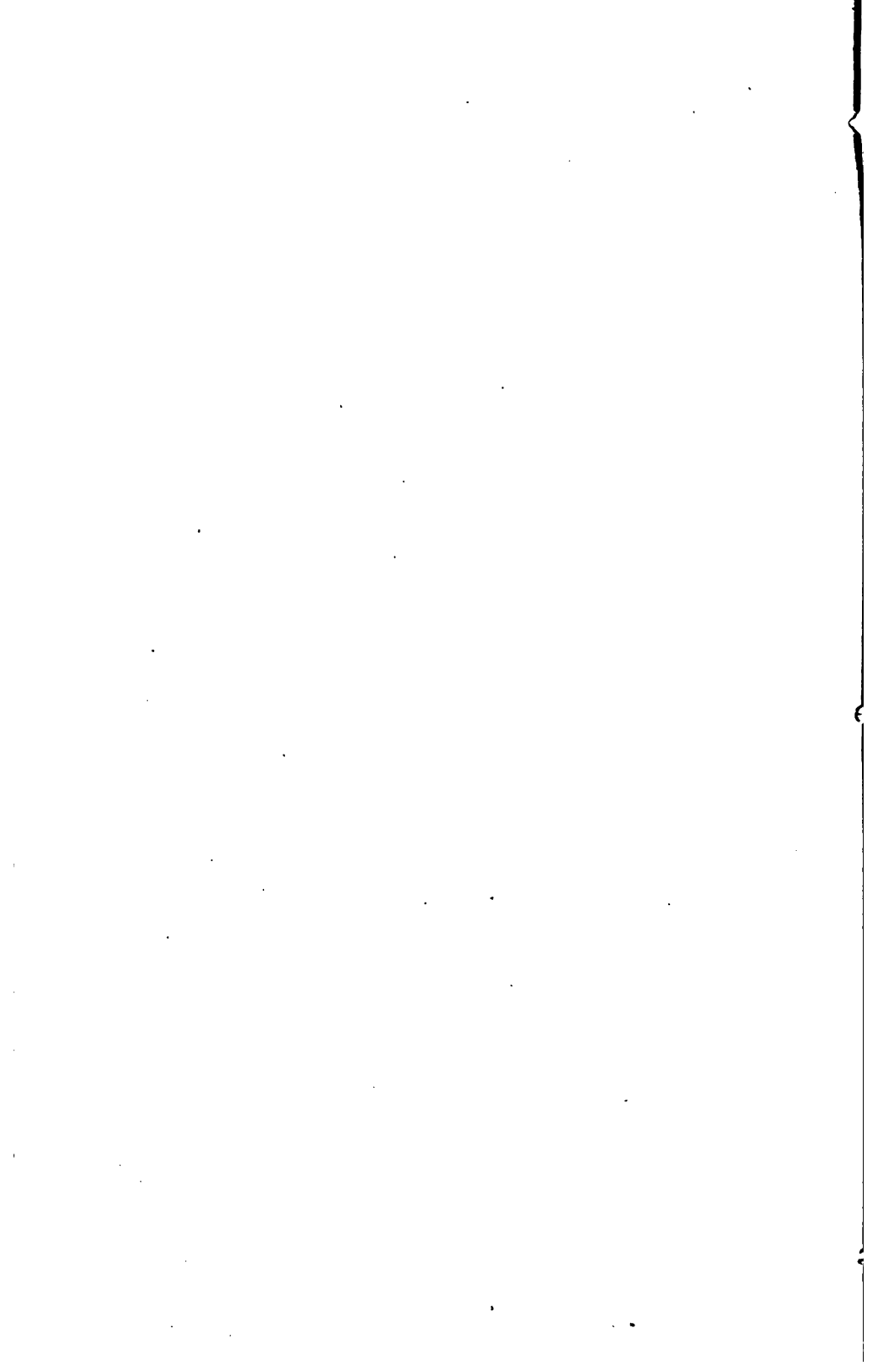

CHAPTER XXXI

AFFINING, MELTING, FILTERING, AND BLEACHING

Historical

WHITE sugar-loaves were manufactured from the sugar-cane many centuries before the present refining process was first used, this early system being probably derived from the Arabs. The boiled syrup was allowed to crystallise in conical moulds, forming a magma of small crystals, and the mother-liquor could drain away through a hole in the pointed extremity of each mould. A mixture of clay and water was then poured over the upper surface of the sugar in each mould, the water slowly percolating through the magma, and washing away the dark-coloured syrup between the crystals. This operation, termed *claying*, was repeated until the crystalline mass became sufficiently white. A very similar method is used to-day in India, having exactly the same object, but substituting wet leaves of certain aquatic plants for the clay. Such sugar-loaves were first imported by Great Britain in 1319, and appeared at the coronation banquet of Henry V in 1413.

In 1812, Howard—the inventor of the vacuum pan—patented the use of saturated sugar solutions for washing the sugar-loaves, in place of the old process of *claying*. His idea was applied in beet-sugar factories by Schutzenbach, was further improved by Steffen, during the years 1884–1888, and ultimately became a method of refining beet sugars. In *Beet Sugar Manufacture and Refining*, Ware refers to a French beet-sugar refinery producing white granulated sugar by washing each charge of raw beet sugar with 32 syrups, or *clairces*, the first having a purity of 69·7, and the last, a purity of 99·9, the colour of these *clairces* decreasing from first to last. He states that 100 kilos. of raw beet sugar,

of 95·8 polarisation, and containing 1·4% ash, after 32 washings yielded 89·8 kilos. of white sugar, of 99·8 polarisation, and containing no ash, leaving a fluid by-product of 54-55 purity, and weighing 10·2 kilos. After the final washing, the crystals were treated in centrifugals to remove the adhering syrup, and then dried in a current of hot air.

In the foregoing methods, crystals were produced directly from cane- or beet-juices, and the *claying* or *syrup-clairce* merely removed the dark-coloured syrup adhering to the surfaces of the crystals.

The term *refining* is more correctly applied to purification by re-crystallisation, a method which was adopted as early as the thirteenth century. In *Die Geschichte des Zuckers*, von Lippmann records that white sugar-loaves were exported from Cyprus, Rhodes, Syria, and Alexandria between the years 1250 and 1400, some of these loaves being made by re-crystallising the dark sugar manufactured directly from cane juice.

The present system of refining is based on this principle, but with the addition of a decolourising process applied to the solution of raw sugar before re-crystallisation. This bleaching-agent—bone-char—was first used for decolourising vinegar in 1810; later, in the manufacture of grape sugar in France; and, subsequently, in the manufacture of white sugar direct from beet juice by Derosne, Payen, and others. At that period, bone-char was made in the form of a fine powder, and was added to the beet juice and finally separated from it by filtration through cloth. After continued use, the bone-char became inactive, and was thrown away.

The successful application of bone-char dates from 1828, when Dumont proposed a method of producing granulated bone-char, which, after continued use, could be heated in furnaces in order to restore its activity, and thus be used repeatedly. This modification had the additional advantage that the sugar solution could be decolorised by flowing through a vessel filled with the granulated char; hence the term *bone-char filters*. This process was patented in 1830, and yielded a very superior quality of white sugar when the bleached sugar solution was re-crystallised in the vacuum pan.

Inferior white sugar made directly from cane- and beet-juices could not compete with this *refined* article, and the new refining process created a steady demand for *raw sugar* to serve as raw material in the refinery, giving rise to a double manufacturing process, offering the following advantages:—(1) It enabled the raw-sugar producer to adopt simple and inexpensive methods of purifying the raw juice; (2) a higher yield of raw sugar could be obtained from 100 parts of cane than when producing white sugar; (3) the sugar refinery can operate on a much larger scale than the raw-sugar factory, thus reducing all working expenses to a minimum; and (4) the refinery need not be located in countries where the sugar-cane and beet are grown, but may be much more favourably situated for the disposal of its manufactured products.

The next step in advance was made in the beet-sugar industry, where scientific research succeeded in producing white granulated sugar, scarcely distinguishable from refined white sugar, but made directly from beet juice without employing bone-char. This achievement naturally roused cane-sugar producers to aim at producing a similar quality of sugar direct from cane juice, but, in order to succeed, they were obliged to borrow the carbonation process from the beet-sugar factory.

Bone-char refining has therefore become less essential than formerly, and may be said to have lost much of its technical interest. But the consumer, so long accustomed to the refined article, continues to demand it, and is not content with white sugar made directly from the cane and beet, because these are sometimes slightly tinted.

VARIETIES OF RAW AND REFINED SUGARS

The refiner has to treat the following:—

Cane Sugar. 1st grade raw sugar, of 96 to 98 polarisation, cured in centrifugals.

2nd and 3rd grades raw sugar, of about 89 polarisation, cured in centrifugals.

Muscovado and mat-sugar, very imperfectly cured by drainage.

Concrete and gur; not cured at all, but representing the dry solid matters of cane juice.

Beet Sugar. 1st grade (nearly white), of about 99.5 polarisation, due to washing with water or syrup in the centrifugals.

2nd grade, moist yellow sugar, of 88% *net analysis*, cured in centrifugals, but not washed.

3rd grade, moist brown sugar, of 75% *net analysis*, cured in centrifugals, but not washed.

From these raw materials, the refiner produces the following qualities of refined sugar:—

(a) Cube sugar. This was formerly made by sawing sugar-loaves into cubes, but is now made by other methods.

(b) Granulated sugar, or loose dry crystals of medium size.

(c) Crystal sugar, similar to (b) but consisting of large crystals.

(d) Castor sugar, similar to (b) but consisting of very small crystals.

(e) Yellow crystals.

(f) Sugar-loaves (these are now obsolete in Great Britain).

(g) Icing sugar, made from waste and broken pieces of cube sugar (a) by grinding to a fine powder in mills.

(h) Soft pieces. This is a second-grade moist sugar, of small grain, made from syrup separated from (b) or (c), and bleached with bone-char before being boiled to grain in the vacuum pan.

REFINING OPERATIONS

The following operations in the refinery are alike for all varieties of white sugar, the above differences only appearing in the final operations.

(1) *Affining*, or washing the raw sugar-crystals to remove adhering molasses.

(2) *Melting*, or dissolving the affined sugar in sufficient water to form a syrup, called *liquor*.

(3) *Filtration of the liquor* through cloth, to separate insoluble, suspended impurities.

(4) *Bone-char treatment*, to bleach and purify the clear liquor obtained from (3). For reasons explained above, this bone-char treatment is effected by filtering the liquor through the char; hence the term *char-filters*.

(5) *Boiling the liquor*, which is accompanied by the formation and growth of crystals.

(6) *Curing the crystals*, or separating the mother-liquor in centrifugal machines, followed by purging with water, or syrup, or steam.

(7) *Drying the crystals*.

The first four operations will be considered in the present chapter.

(1) *Affining*

As the quantity of bone-char required to treat 100 tons of raw sugar increases as the purity of this sugar decreases, the object of *affining* is to remove the greater part of the molasses adhering to the crystals, before they are dissolved in water. When a pure syrup is used for washing, the operation exactly resembles the *second curing in the "after-workers,"* in the manufacture of white sugar direct from the cane or beet (p. 305); and the success mainly depends on the size of the crystals to be washed. For example, 100 tons of coarse-grained sugar, of 96% polarisation, yield from 80 to 90 tons of *affined sugar*, of 99.0 to 99.5% polarisation; whereas, 100 tons of fine-grained raw sugar, of 89% polarisation, yield from 65 to 70 tons of *affined sugar*, of 97.5 to 98.5% polarisation. In the Weinrich Process, affining is effected with steam and carried out in special centrifugals.

Superior raw sugars, made from cane or beet, may be rendered sufficiently white and pure for direct consumption by affining only; and large quantities of *affined* beet sugar have been sold as *refined granulated* without being treated with bone-char. But the main object is to increase the purity of all low-grade raw sugars before these are dissolved, so that the resulting *liquor* may contain the minimum of dissolved non-sugars to be removed by the bone-char treatment.

The dark-coloured washings are treated separately from the liquor made by dissolving the affined sugar in water, and are not treated with bone-char. They are boiled to grain in a vacuum pan, forming a low-grade massecuite which is *cured* in centrifugals, and yields a brown sugar, and a fluid by-product—*treacle*.

(2) *Melting*

The *affined sugar* is elevated to the top-floor of the refinery and discharged into the *melting-tanks*. These are large cylindrical vessels about 5 feet in depth, and capable of holding from 5 to 10 tons of sugar and sufficient water to form *liquor*. They are fitted with mechanical stirrers, and the contents are heated by means of steam-coils or perforated steam-pipes. A false bottom of perforated metal is placed above the steam-coil to support the sugar during the melting operation.

Water is added in such proportion that when the whole of the sugar is dissolved, the *liquor* attains a density of 27° to 29° Beaumé (specific gravity of 1.235 to 1.257), and is heated to a temperature of 150°–170° F. The purity of this liquor may be controlled by blending different grades of raw sugar (*affined* or not) in each melting-tank, thus securing liquor of uniform purity every day, and ensuring uniformity in the daily routine work.

Formerly, certain clarifying agents were added to the liquor to assist the filtration which follows, but most of these are now obsolete. Sufficient lime-cream is usually added to render the *liquor* very faintly alkaline, thus preventing the development of bacteria. The addition of lime and phosphoric acid, to form a precipitate of tricalcium phosphate, is also adopted to assist filtration.

(3) *Filtration of the Liquor*

All suspended impurities are separated from the *liquor* by passing it through cloth filters. Filter-presses (Fig. 19, p. 214) have been successfully employed in beet-sugar refineries because this class of sugar is made from *filtered* beet juice,

and therefore contains very little colloidal matter in suspension. *Liquor* made from raw cane sugar is much more troublesome to filter, since these crystals are made from *unfiltered* cane juice, and the *liquor* contains very fine particles of colloidal matter in suspension. In this case, Taylor Bag-filters (Fig. 18 on p. 209) are preferred, although they necessitate more manual labour than when employing filter-presses. The following materials are used for assisting filtration :—powdered bone-char and wood-charcoal, sawdust, kieselguhr, lignite, etc. When the filter-cloths become coated with solid matters, hot water is passed through the filters to wash out the liquor; such washings being pumped back to the melting-tanks, and used for diluting the next charge of raw liquor.

(4) *Bone-char Treatment*

From 1500 pounds of bones there are obtained about 100 pounds of bone-char, having the following composition :—

Carbon	10 to 11%
Calcium phosphate	73 " 80%
Calcium carbonate	7 " 8%
Nitrogen	1.0%
Other mineral matters	traces

One litre of granulated char weighs from 650 to 750 grams, this apparent density being an indication of the hardness of the grains of char, and the tendency to become powdery during use. One ton of unwashed raw sugar in the form of liquor may require two tons of char to render it colourless; but the same sugar, after being *affined*, requires only about its own weight of char.

Char-cisterns, or Char-filters.—These are cylindrical vessels, about 10 feet in diameter, and from 20 to 50 feet in height. One of average size will hold about 20 tons of char, saturated with 10 tons of liquor. Each cistern has a door at the top for introducing the char, and a discharge-door near the bottom for removing the spent char in order to revivify it. Near the bottom of the cistern is a perforated false-bottom, covered with suitable cloth, or flannel, upon which the mass

of char rests, so that any char-dust suspended in the liquor is removed by filtration at the bottom of the cistern.

The liquor to be treated enters at the top, and descends through the column of char in from 3 to 6 hours, finally escaping from an outlet at bottom. By means of numerous pipes and valves, each cistern can receive:—(a) dark liquor passing from the cloth filters; or (b) partially bleached liquor passing from another char-cistern; or (c) hot water for washing the spent char free from syrup, before it is discharged.

The liquor-outlet at bottom is extended vertically upwards to the top of the cistern, thus forming an overflow-outlet. By this arrangement, the char is completely immersed in liquor, and the descending liquor is more perfectly distributed throughout the char than if it escaped directly from the bottom.

Operating.—When a char-cistern is first brought into action, it is filled with liquor to the overflow-level, and left undisturbed for 2 or 3 hours, to allow the char to settle down, to become fully saturated, and the contained air to escape. After this, the inlet-cock is opened, admitting a continuous feed of dark liquor, and a continuous discharge of bleached liquor flows from the outlet-pipe into a gutter which leads to a receiver for *white liquor*. After a certain period, the activity of the char decreases (owing to the absorption of organic matters from the liquor) and the liquor assumes a yellow tint. At this point, the escaping liquor is received in a second gutter (running parallel to the first) and is conveyed to a receiver for *yellow liquor*. The colour of the treated liquor gradually increases, and, when it reaches a certain depth, the inlet-cock is closed, thus putting this cistern out of action, whilst another, containing fresh char, takes its place.

Washing the Char.—Hot water is now passed through the former to remove the contained syrup, the washings flowing into the gutter for *yellow liquor* until their density falls to about 18° Beaumé (1.140 sp. gravity). The outlet-pipe is now placed over a third gutter, and the washing continued until the density falls to less than 0.5° Beaumé. Thus, the colour-

less and undiluted liquor flows into one receiver, the *yellow liquor* and high-density washings pass to a second receiver, and the dilute washings to a third receiver.

Washing is continued for 2 or 3 hours longer, but the escaping liquid now contains only traces of sugar, and is run to waste. After washing is complete, a cock is opened at the bottom of the cistern to permit the residual wash-water to drain off from the char.

The second washings (from 18° to 0.5° Beaumé) are strongly coloured, and are sometimes returned to the *melting-tanks* to be used for preparing fresh portions of raw liquor. Or, these rich washings may be concentrated to a density of 28° Beaumé in a multiple-effect evaporator, treated with bone-char, and converted into *white liquor*.

Revivification of the Char.—After the final washings have drained off, the wet char is discharged through the lower door, and falls upon a horizontal transporter extending below the battery of char-cisterns. This transporter delivers the char to an elevator, and the latter conveys it to a drying apparatus placed above the char-kilns, and heated by the waste-gases from the kiln-furnaces. The wet char descends through the *drier* by gravity and is exposed to an upward current of gases, entering the *drier* at a temperature of 750° F., and escaping to a chimney (above the drier) at a temperature of 400° F., carrying away the evaporated water. On reaching the bottom of the drier, the char enters the char-kiln.

The earlier form of kiln was a rotating cylinder, heated externally by a furnace, and sloping slightly from the horizontal. The char entered through a hopper at the upper extremity, and, during its passage through the cylinder, was repeatedly raised and dropped by shelves rotating with the cylinder, being thereby kept in constant motion, and discharged from the lower end of the cylinder into an air-tight chamber.

Most modern refineries employ the *pipe-kiln* shown in Fig. 37. This consists of a brick furnace enclosing a number of vertical tubes, through which the dried char gravitates at a sufficiently slow speed, the upper extremities of these tubes being flush with the base, or floor of the *drier*. The tubes

extend far below the floor of the furnace and are closed at their lower extremities by mechanical valves, which permit

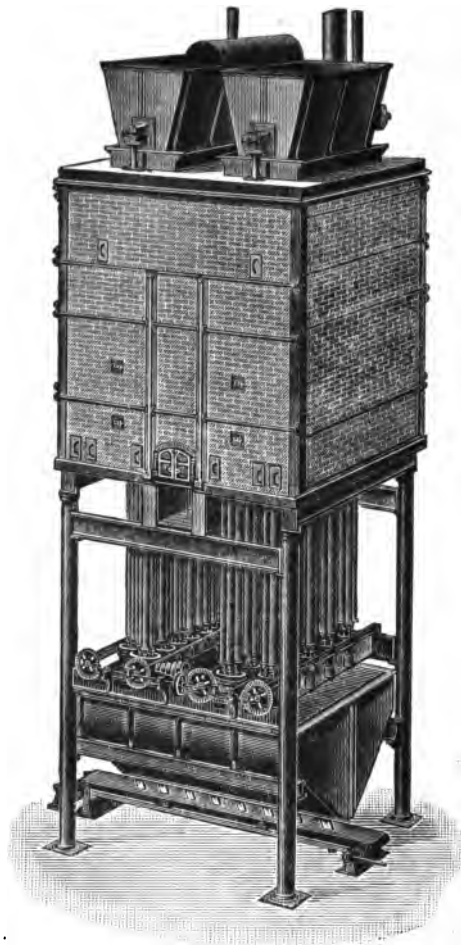

FIG. 37.—CHAR PIPE-KILN

From Thorpe's *Dictionary of Applied Chemistry* (Longmans & Co.)

a certain weight of char to fall from the tubes per minute, without admitting air to the tubes. In some designs, the tubes also extend vertically above the top of the furnace, these being employed for drying the wet char. The pipes

passing through the furnace are heated to about 1050° F., causing complete combustion of the organic matters in the char (revivification); and the pipes extending below the furnace are termed cooling-pipes, the cooled char dropping from the mechanical valves, and falling upon a horizontal travelling-band. The char then passes to an elevator, and returns to the hoppers above the char-cisterns. The rate at which the char descends through the pipe-kiln can be regulated by suitable adjustment of the discharge-valves; one pipe discharges from 16 to 24 ounces of char per minute.

The normal decolourising-power of the char is fully restored after the first ignition in the char-kiln, but each subsequent ignition is less effective owing to the accumulation of mineral matters abstracted from the raw liquor, and left in the re-burnt char. After being in use for four or five years, it becomes inactive and is sold as a by-product (p. 411).

Operating a Battery of Char-cisterns.—The mode of operating differs somewhat in different refineries, according to the purity of the raw liquor, and the class of refined sugar being made. Formerly, the same liquor passed through two, or even three cisterns in succession; the first having been in use for some time, the second for a shorter period, and the third containing recently burnt char. The liquor was thus bleached in three stages, and the decolourising-power of the char was utilised to the fullest extent. But the liquor tends to become acid during its slow passage through the separate cisterns.

The modern practice is to distribute the liquor between two or more cisterns, operating in unison, the flow through each being adjusted to ensure proper bleaching, and the colourless liquor being separated from the tinted liquor (as explained above) when the activity of the char decreases in course of time. In this plan, the char-cisterns are worked in groups; each group, in turn, being brought into action as soon as the previous group is stopped in order to wash out the liquor from the spent char. A third group is discharging the washed char, and a fourth group is re-charging with revived char.

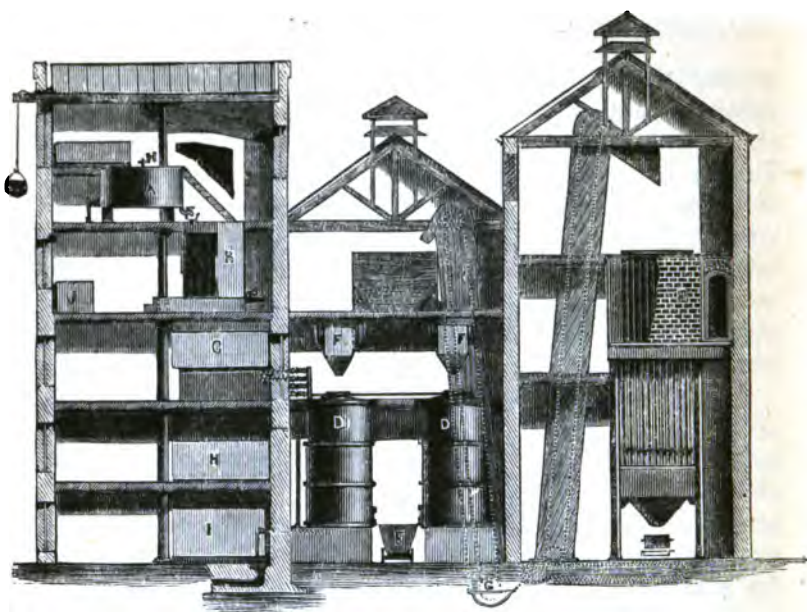

Elevation

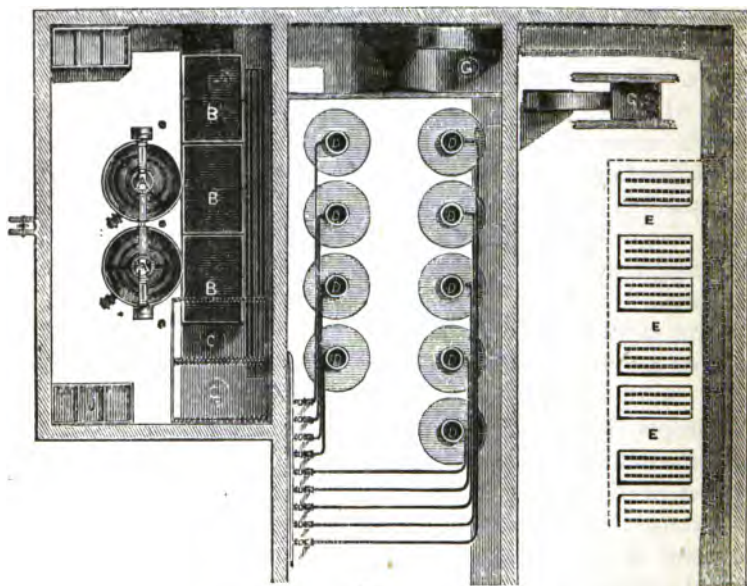

Plan

FIG. 38.—LIQUOR-DEPARTMENT OF REFINERY
 From Thorpe's *Dictionary of Applied Chemistry* (Longmans & Co.)
 398

If two grades of liquor are to be treated, that having the higher purity is passed through the most active char until the bleaching becomes inefficient, and is immediately followed by the liquor of lower purity, which completely displaces the former. The second liquor, partially bleached by old char, now enters another cistern containing fresh char, where the bleaching is completed. Here, also, the bleaching-power of the char is fully utilised; and, for washing the spent char, less water is required per ton of liquor treated, and less sucrose runs to waste in the last washings.

The general arrangement of the plant used in preparing and bleaching the refinery liquor is illustrated in Fig. 38. The melting-tanks (or "blow-ups") are shown at A, A; Taylor bag-filters at B, B; clear-liquor tanks at C, C; char-cisterns (or char-filters) at D, D; char pipe-kilns at E, E; char-trucks at FF (mechanical transporters are more usual); char-elevator at G; *white-liquor* tanks at H, H; *yellow-liquor* tanks and char-washings at I, I. A modern refinery produces considerably over a thousand tons of refined sugar per week.

The largest refinery yet built produces 1340 long tons per day, or 8000 tons per week, and is owned by the American Sugar Refining Company. The following brief description may be of interest. The raw sugar is *affined* in one building, having 3 *mixers* and 30 centrifugals, and the affined crystals are elevated to the fourteenth story of an adjacent building, and dissolved in 25 melting-tanks. The resulting *liquor* is filtered in 61 Taylor filters (21,500 filter-bags) located on the twelfth story, and gravitates to a lower floor equipped with 87 char-cisterns, 47 of which are required for white, 28 for second-grade, and 12 for third-grade liquors. These char-cisterns extend downwards to the seventh floor, the lower floors being occupied with 38 char-driers, char-kilns, and cooling-pipes; the re-burnt char being elevated from the ground-floor to the tenth story, immediately over the char-cisterns.

The boiling and crystallising operations are conducted in another vast building, equipped with 2 quadruple-effect Lillie evaporators, 10 vacuum pans with re-heaters, 20 vessels for

crystallisation in motion, 48 centrifugals for curing first-grade sugar, and 32 for second-grade.

The cured sugar then passes to storage-bins on the ninth story of a third building, and gravitates through 16 hot-air driers (*granulators*) to the dry-sugar bins, and still lower to the bagging and weighing machines.

The following chapter deals with crystallisation and subsequent operations.

CHAPTER XXXII

CRYSTALLISATION AND BY-PRODUCTS

(5) *Boiling the Liquor*

THE colourless liquor is boiled and grained in the vacuum pan in the same manner as cane- or beet-syrups, but the size of the fully-grown crystals varies with the class of refined sugar to be made. A very small grain is required for *cube* and *castor sugars*, and *sugar-loaves*; a medium grain for ordinary *granulated*; and a very large grain for *crystal sugar*; these variations being obtained by graining the pan *high up* or *low down*, as explained on p. 281. A fine-grained masse-cuite is boiled at a temperature of 120°–140° F., and one strike may be completed in from 3 to 4 hours. A large-grained masse-cuite is boiled at a temperature of 160°–180° F., and one strike may occupy from 8 to 10 hours. The much larger grain required in *crystal sugar* is only obtained by repeatedly *cutting the pan*, or *doubling* (p. 283).

Formerly, the refiner produced three, or even four grades of sugar (only the first being white) by means of *separate boilings* (p. 309); but the system of *mixed boilings* (p. 312) is now generally employed in order to obtain the highest possible yield of first-grade, and the minimum yield of coloured low-grade sugars. The latter must either be sold at a low price, or treated as raw sugar in the melting-tanks, and passed through the refining operations again.

The first-grade masse-cuite passes from the vacuum pan into *re-heaters*, resembling the vessels used for *crystallisation in motion* (p. 290), and fitted with steam-jackets. It is gently stirred and heated to 176°–185° F. (80°–85° C.) to render it more fluid, of uniform composition, and to dissolve any fine grain which may be present.

In some large refineries, the liquor is partially concentrated

in a multiple-effect evaporator before it enters the vacuum pans, thus removing a considerable proportion of water with a very small consumption of fuel.

(6) *Curing and Drying the Crystals*

In this department of the refinery, the white sugar assumes various forms to meet the public fancy; the methods of operating will therefore be described under the following headings.

(a) *Granulated Sugar (including Crystal and Castor)*

The massecuites are cured in centrifugals of the same type, and in the same manner as white granulated sugar made directly from cane- and beet-syrups (Chapter XXV); the refined crystals being rendered sufficiently white by purging with water, syrup, or steam, without resorting to double-curing.

The purged crystals are usually passed through a hot-air rotary drier, called *the granulator*. This method of drying has the disadvantage that the crystals rub against each other, thus tending to lose their sharp angles and edges, and acquiring a dull appearance. The drying may also be effected by admitting superheated steam to the centrifugal, after purging, and passing the heated sugar through a rotary sifter. The trace of moisture rapidly evaporates as the crystals fall from the sifter, and the sugar is thus cooled before being bagged off. Any agglomerated lumps of sugar remain in the sifter, and can be used in various ways.

(b) *Cube Sugar*

This class of sugar was originally made by sawing large sugar-loaves into small cubes, and the name *loaf sugar* is still applied to cube sugar when made by the following methods:—(a) The hot massecuite passes from the *re-heater* into rectangular metal moulds, where it “sets” during partial cooling. The filled moulds are then placed in special centrifugals, in which the fluid mother-liquor is separated, and the crystals purged with pure syrup; after which the moulds are

removed from the centrifugal, opened, and the slabs of white sugar dried, and cut up into cubes. Each slab has the thickness of a cube, and is cut lengthwise into strips, and again, at right angles into separate cubes, by means of special machinery. In the alternative method (*b*), the massecurite is cured and purged in the ordinary centrifugals, and the resulting white sugar is mixed with a pure syrup and pressed into small cubical moulds in a special machine.

These two methods will now be briefly described.

Method (a) (Vivien's Moulds).—The empty moulds are closely packed, in parallel rows, upon a hand-truck, moved into position below the *re-heater* (p. 401), and filled with massecurite. After sufficient time the massecurite *sets*, and the moulds are placed radially in a special centrifugal, and fixed in position by means of metal wedges. The machine is run at full speed for 20 minutes, the mother-liquor escaping through perforated extremities of the moulds adjacent to the cylindrical wall of the drum. Whilst the machine is in motion, a colourless purging-syrup is added at the centre of rotation, and is automatically distributed over the open ends of the moulds (which form an inner circle, near the centre of rotation). The machine is kept in motion for another 20 minutes, to allow the purging-syrup to penetrate the moulds and escape from the drum, after which it is brought to rest. The moulds are removed, opened, and the slabs of white sugar conveyed to the drying-ovens, and finally cut up into cubes.

(Adant Process).—This closely resembles the foregoing as regards method, but involves less manual labour. The empty moulds are arranged vertically and radially between two horizontal, flattened rings, forming the outline of a short vertical cylinder, having the exact dimensions of the centrifugal drum or basket. The individual moulds are merely spaces between parallel, rectangular plates, arranged vertically between the above-mentioned rings; the upper and lower edges of the plates sliding in grooves on the inner surfaces of these rings. The plates are arranged in groups, each group being separated by a wedge-shaped partition, so that all the plates and the intervening moulds are placed nearly radially to the central axis of the whole structure. This type of mould

simplifies the manipulations when the cured sugar-slabs are removed.

The complete framework is put together in a few minutes by one man, lifted in one piece by a crane, and lowered into a steel cylinder, into which it fits closely. A smaller cylinder is inserted in the central, annular space, not occupied by the moulds. The exterior cylinder, being mounted on wheels, is moved into position below the *re-heater* (p. 401), from which the hot massecuite flows into the moulds through slots cut in the upper ring (or top of frame).

After cooling for about 12 hours, the massecuite solidifies in the moulds. The crane now lifts the frame (and attached moulds) out of the exterior cylinder and lowers it into the centrifugal basket. The machine is driven at 700 revolutions per minute to separate the mother-liquor, then reduced to 200 revolutions, and a colourless washing-syrup is added at the centre of rotation, and automatically distributed over the inner edges of the moulds. The speed is again raised to 700 revolutions per minute to force the washing-syrup through the moulds, and out of the drum, after which, the machine is brought to rest. The crane raises the frame (and attached moulds) from the centrifugal and deposits it upon a stand, where the structure is taken to pieces. The slabs of white sugar are removed, dried, and cut up into cubes, as in the Vivien Process.

The centrifugal is of special design, and one machine treats from 15 to 16 tons of sugar in 24 hours.

Method (b) (the Hersey Process).—A small-grained massecuite is cured and purged in the ordinary type of centrifugal, and the resulting white sugar is mixed with sufficient colourless syrup to form a thick magma, which is fed into the hopper of the machine shown in Fig. 39. The lower part of this hopper is in contact with a slowly rotating, horizontal drum, the surface of which is pierced with square holes, in parallel rows, each hole forming a mould for a single sugar-cube. As the drum rotates, the moulds immediately below the hopper are filled with the magma, and then move forwards and downwards. During this motion, the contents of every mould are compressed between a piston (moving within each mould)

and an exterior rigid steel plate (concentric with the drum). This plate temporarily closes the mouths of the moulds until the drum has made a half-revolution. The moulds then pass beyond this plate, and the pistons push the sugar-cubes

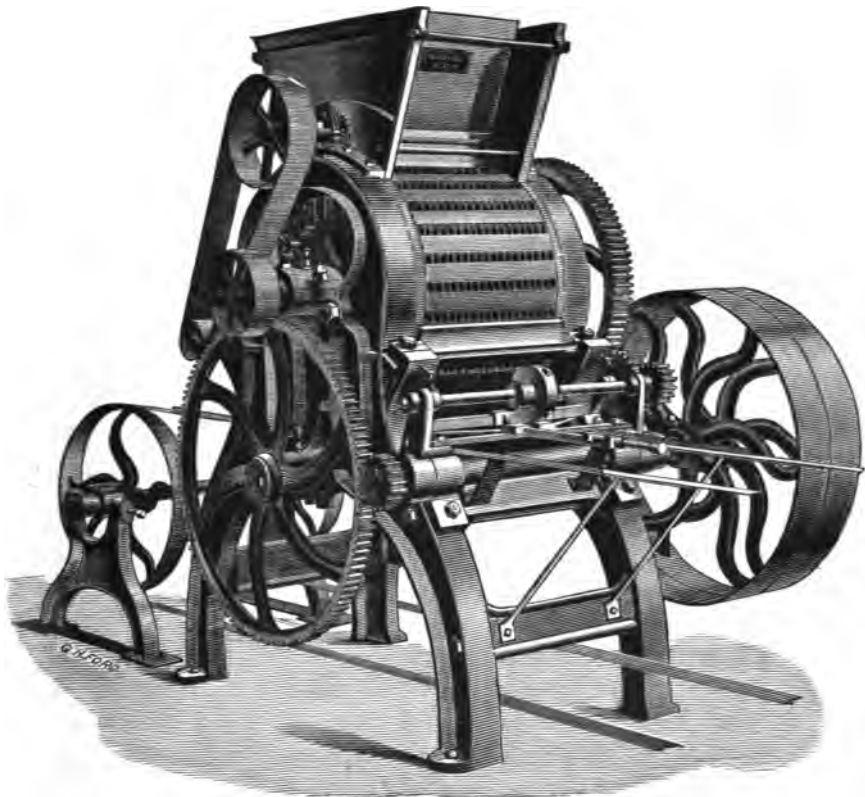

FIG. 39.—HERSEY CUBE-SUGAR MACHINE

From Thorpe's *Dictionary of Applied Chemistry* (Longmans & Co.)

out of the moulds on to metal trays, carried on a travelling-band, which moves horizontally immediately below the drum. The empty moulds continue their rotary motion until they again pass below the hopper and are re-filled.

As the travelling-band moves horizontally with the same linear velocity as the circumference of the drum, the band (or

transporter) is covered with parallel rows of cubes, and carries them slowly through a hot-air drying-chamber, and beyond this to the packing-room. The cubes are dried during their motion through the drying-chamber, and fall into the packing-boxes without being handled. One Hersey machine can produce 250 tons of cube sugar per week.

The *Pzillas machine* was invented before the Hersey, and operates on exactly the same principle, but forms sticks instead of single cubes, the sticks being subdivided into cubes by another machine.

Sugar in the form of *true cubes* is mainly produced in British and American refineries, and the cubes have rough surfaces and a sparkling appearance, due to the size of the individual crystals composing them. They are made from raw cane sugar, raw beet sugar, or from a mixture of the two. Continental beet-refineries produce small *rectangular slabs* (instead of *cubes*), having a much smoother and duller surface, due to the very small crystals composing them. As this kind of refined sugar is only made from raw beet-sugar, its external form is sufficient to distinguish it from refined cane-sugar.

It is of interest to remark that many Continental refiners only buy and treat raw beet-sugar in the form of *white granulated beet*, converting this into rectangular lumps, of exactly the same purity as the raw sugar treated. Such refineries exist because the fastidious public prefers *lumps* to *loose crystals*, of equal purity! The impure raw beet-sugars, rejected by these refiners, were bought by British refiners and converted into the finest quality of white cube sugar, clearly proving the superior technical skill of the British refiners.

(c) *Sugar-loaves*

This form of refined sugar is now so rarely produced that it will be sufficient to refer the reader to the following works:—

Ware's *Beet Sugar Manufacture and Refining*, Vol. II,
Part vii, chapter 2.

Lock and Newlands' *Sugar*, pp. 651-4.

(d) *Yellow Crystals*

This quality is made from white granulated sugar, cured and purged as described above, and then mixed with about 2% of golden syrup, and sufficient *golden-bloom* (aniline dye) to imitate the colour of Demerara yellow crystals.

(e) *Low-grade Sugars*

Before the affining process was adopted, the soluble impurities of the raw sugar passed into the *liquor*, thence into the syrup boiled in the vacuum pans, and finally into the mother-liquor (treacle) separated from the lowest grade of crystals.

In the affining process, the impurities of the raw sugar are separated in the first operation, and pass at once into the washing-syrups (A) leaving a very small quantity in the washed crystals, and in the *liquor* (B) made therefrom.

(A) *Affining-syrups*.—These are not treated with bone-char, but boiled and grained in a separate vacuum pan, the resulting massecuite cooled in motion and cured, yielding a moist brown sugar and a by-product—treacle. If there be no market for this brown sugar, it may be *melted* in a separate melting-tank, re-crystallised in the vacuum pan, and the cured sugar mixed with raw sugar in the large melting-tanks, thus passing through the refinery operations again.

(B) *Liquor made from Affined Raw Sugar*.—This is boiled in the vacuum pans to form first massecuite (as explained above) and yields first-grade white sugar and a coloured syrup (mother-liquor) of high purity, which we will denote by (C). If this be re-boiled to form a second massecuite, the resulting second-grade sugar is slightly coloured, and difficult to dispose of.

Many refineries avoid the difficulty by converting this syrup (C) into *golden syrup*, for the public appears to regard *colour* as a guarantee of purity in the case of syrup, whilst strongly objecting to a faint colour in the case of crystals! The refiner's task is to please the public, not to educate it. He therefore only re-boils a portion of the syrup (C) to form a second-grade sugar for the market, and converts the

remainder into an uncrystallisable syrup by the process described below.

In refineries which do not manufacture this table-syrup, the original syrup (C) is treated with bone-char, boiled and grained in the vacuum pan, cured, and yields a moist sugar termed *soft-pieces*, of a pale yellow colour, but of lower polarisation and purity than the raw sugar from which it is derived. Another alternative is to mix the syrup (C) with the sweet-waters (washings) from the bag-filters, and the char-cisterns, and use this coloured liquor for *melting* low-grade raw sugars separately from the high-grade and affined raw sugars.

Golden Syrup

Whereas *treadle* is a by-product of the refinery, *golden syrup* is a manufactured product, being made from cane syrup of high purity, as a substitute for second-grade sugars. The material must have a high density, perfect transparency, and an attractive colour, and, in order to combine these qualities, crystallisation must be prevented by *inverting* part of the contained sucrose because the subsequent formation of crystals would render the syrup cloudy and unsaleable. This inversion is effected by diluting the above-mentioned syrup (C) with hot water to a density of about 25° Beaumé in large cylindrical vessels (lined with lead) and fitted with mechanical stirrers and steam-coils. A measured quantity of dilute sulphuric acid is run in, thoroughly mixed with the diluted syrup, and the mixture heated until the analysis of a sample indicates a certain ratio between *uninverted* sucrose and invert sugar. The acidity is then neutralised by the addition of lime-cream or powdered chalk, and the insoluble calcium sulphate separated in cloth filters. The transparent, filtered liquid is treated with bone-char, and finally concentrated to the desired density in a vacuum pan.

The details of manufacture are a trade secret, each manufacturer having his own formula. The keeping quality of the syrup depends on the degree of inversion, namely, the acidity, the period of heating, and the temperature, which

are carefully controlled by the chemist. The approximate compositions of refinery treacle and golden syrup are given below, and should be compared with cane-molasses (p. 356) and beet-molasses (p. 376).

	Refinery Treacle (Cane).	Golden Syrup.
Water	18-24	16-17
Sucrose	34-36	30-33
Invert sugar	30-32	44
Mineral matters	3-6.5	2.0
Organic non-sugars	3-8	3.5-8.0

Losses during Refining

The sugar losses in the refinery are smaller and much more difficult to measure than those in the raw-sugar factory. They vary considerably with the quality of raw sugar treated, and qualities of the refined sugars produced. The following estimates illustrate these variations.

(a) *Treating Raw Beet Sugar, of Moderate Purity.*—Von Lippmann gives the following estimates for Continental refineries:—

From 100 tons of raw beet sugar (containing 95.5% sucrose, 1.8% water, 1.0% ash, and 1.7% organic non-sugars) there are obtained 90 tons of white refined sugar (100% sucrose) and 9 tons of uncrystallisable treacle (46% sucrose).

Loss in weight = 100 - (90 + 9)			
From 95.5 tons sucrose in raw sugar, there are obtained 90.0 tons sucrose in crystals and 4.14 tons in treacle			Per cent. on Raw Sugar. 1.0
∴ Total loss of sucrose = 95.5 - (90 + 4.14)			1.36
Organic non-sugars in the raw sugar = 1.70	} % on	raw sugar	
„ „ „ treacle = 2.06			
Increase during refining, due to decomposition of sucrose by heat in vacuum pans	} 0.36%		0.36
Mechanical losses of sucrose = 1.36 - 0.36.			

(b) *Treating Raw Cane Sugar, of Moderate Purity.*—Battelle gives the following estimates for American refineries:—

From 100 tons of raw sugar (96 polarisation) there are obtained 92.5 tons of refined sugar (100 polarisation), 2.5 tons remain in the treacle, and 1.0 ton is lost.

(c) *Treating White, Granulated, Raw Beet Sugar.*—Wasilijeff gives the following estimates for a Russian refinery :—

From 100 tons of raw beet sugar (99·6% sucrose) there are obtained 99·2 tons of refined white sugar (100% sucrose).

		<i>Per cent. on Raw Sugar.</i>
Sucrose left in treacle.	=	0·55
Sucrose lost in bone-char	0·042	} = 0·06
" " wash-waters	0·017	
Undetermined losses (by difference)	=	0·27
Total sucrose lost	=	0·88

The sucrose left in the treacle is not reckoned as a loss, since it gives a market-value to this by-product, and is directly accounted for by analysis. Omitting this item, the foregoing estimates may be compared as follows :—

	(a)	(b)	(c)
Total loss of sucrose	1·36	1·0	0·33
Decomposition of sucrose during boiling in vacuum pan	0·36	not stated	0·27
Mechanical losses of sucrose	1·00	„	0·06

The total loss of sucrose in British refineries is generally stated to be 1·0%, half of this being attributed to decomposition of sucrose by heat, and half to mechanical losses.

Refinery By-products

(1) *Treacle.*—This is the uncrystallisable, fluid residue of the refinery, and corresponds to the by-product—molasses—in the raw-sugar factory, with this difference, that treacle is obtained from the dark syrups separated from the raw-sugar crystals in the *affining process*, and is therefore not the *final product* separated from the refined sugar crystals.

The composition of this treacle naturally varies when the refinery operates upon raw cane sugar, raw beet sugar, or mixtures of both. Cane-sugar treacle contains about 35% of sucrose, and about 30% of reducing sugars, and has long been used as human food.

Beet-sugar treacle contains about 50% of sucrose and only 1 or 2% of invert sugar. On account of its unpleasant odour

and flavour, and high percentage of mineral impurities, it is quite unsuitable for human consumption, but can be mixed with other materials in the manufacture of cattle-foods, such as *Molassine* (p. 369). In many French and German refineries, the contained sucrose is extracted by Steffen's *Separation Process* (p. 339) and the fluid residue is sold to distilleries.

(2) *Refined Treacle*.—A superior quality of cane-sugar treacle is obtained by diluting the raw treacle with water, filtering through cloth to remove suspended impurities, bleaching with bone-char, and concentrating to a suitable density in the vacuum pan.

(3) *Spent Char*.—After the bone-char has been in constant use, and repeatedly revived in the char-kilns, it has to be rejected, and is utilised as a fertiliser, being rich in calcium phosphate.

In concluding this brief study of the sugar factory and refinery, attention may be drawn to the fact that the remarkable technical progress made within the past century has not been effected by the so-called *practical man*, or *sugar producer*, but by a comparatively small number of men who built the *theoretical foundations* upon which modern practice stands. Many centuries of *practical experience* failed to improve the primitive methods of cane-sugar manufacture. *Theory* evolved a new plant (the sugar-beet); discovered and perfected a new method of extracting the sugar; and within 84 years enabled Germany to produce over a million tons of beet-sugar per annum!

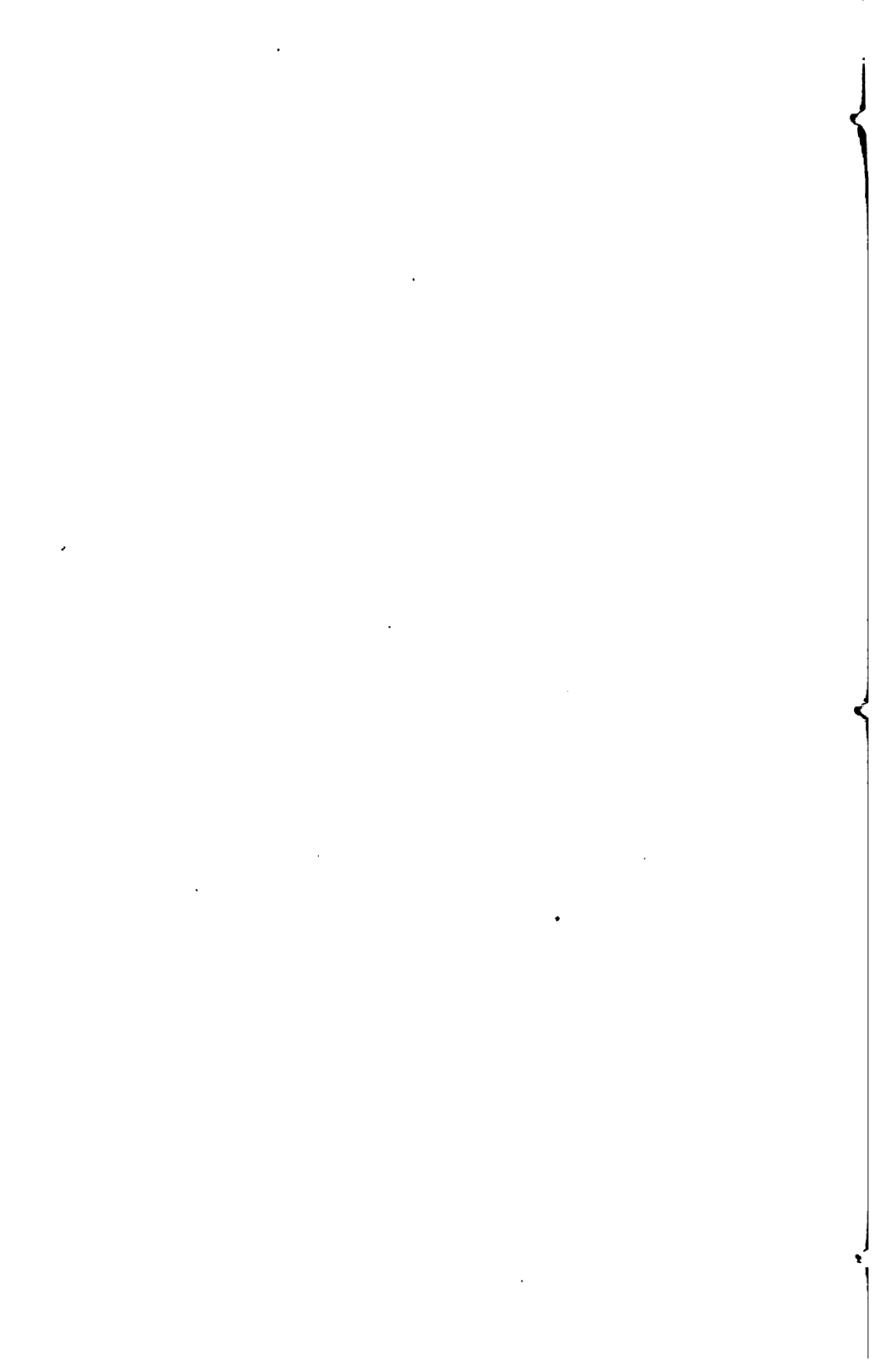

INDEX

- ACETIC ACID, in cane-juice, 128
manufacture from alcohol, 363
manufacture from bagasse, 351-352
- ACETONE, *manufacture from cane-molasses*, 357, 363-364
- ACIDITY, determination of, 189, 193
 and inversion of sucrose, 110, 173, 193
- ACIDS, *action on* fructose, 116
 glucose, 116
 raffinose, 124
 sucrose, 110-111
- AFFINING of raw sugar, 390-392, 407
- AFTER-product, 285
 -workers, 305
- AIR in cane-juice, 126, 194, 201
- ALBUMIN in beet-juice, 139-140, 230
 cane-juice, 128, 129, 180
- ALCOHOL, *manufacture of*, from bagasse, 352
manufacture of, from molasses (*see under Beet and Cane*)
- ALDOSE Sugars, 118, 120, 121, 124-125
- ALKALINITY of juice, determination of, 232
- ALKALIS, *action of*, on fructose and glucose, 116, 129, 180, 196
action of, on sucrose, 111-112
compounds with sucrose, 113, 336-342
- AMIDES, 130
- AMINES, 128
- AMINO-ACIDS, 128, 129, 139, 141
- AMMONIA-compounds in beet-juice, 139-140, 230
 -compounds in cane-juice, 128-129
 -pipes, 259
- ANALYSIS OF bagasse, 345
 beet, 138, 144
 cane, 126, 144
 filter-press cake (*beet*), 374-375
- ANALYSIS OF filter-press cake (*cane*), 353
 juices, syrups, etc., 145, 149, 151
 lime and limestone, 161
 massecuite, 284-285
 megass (*see Bagasse*)
 molascuit and molassine, 370
 molasses (*beet*), 308, 376
 molasses (*cane*), 308, 356
 sugars, 322, 409
 treacle, 409
- ANTHOCYAN, in cane, 128, 131, 183, 190
- APPARENT AND TRUE dry solids %, 145
 purity, 148, 308, 314
 sucrose %, 146
- ASH IN beet, 142-143
 cane, 135-136
- ASPARAGIN in beet, 129, 141
- ASPARTIC ACID in beet, 141
- ATTENUATION during fermentation, 359
- AULARD'S sulphitation of beet-juice, 238, 239
- AVAILABLE heat units, 346
 raw sugar, 153
 sucrose, 151, 326-329
 white sugar, 151
- AVOIDABLE LOSS in molasses, 326
- BACH'S Sulphitation Process, 192, 194
- BACILLUS levaniformens, 134
- BAGASSE calorific value, 345-346
 composition, 345
 extraction of sugar from, 66-71
 -filters, 212-213
 loss of sucrose in, 58-61, 323, 345
 molascuit made from, 351, 369-370
 paper made from, 349-351
 physical properties of, 42, 349
 saturation of, 37-42, 51-54, 60
 wax, extraction from, 351

- BALLING Saccharometer**, 106
BARIUM Saccharate Process, 337
BARRESWIL'S (*Fehling's*) copper solution, 119
BATTELLE'S Carbonation Process, 197, 336
BETT, analysis and composition, 138, 144
 cultivation, 17
 diffusion process, 75-79, 80, 89, 97, 143
 -factory by-products, 372
 flower of, 12, 13
 forage-, 10; 11
juice, analysis and composition, 138, 145
 darkening of, 140
 density of, 96-97
 non-sugars in, 139-143
 purity, 94-96, 147, 154-155
massecuite, 285
molasses, alcohol from, 376
 composition, 308, 376
 exhausted, 324, 326, 376
 fertilizer, 382
 grain present in, 326
 nitrogen in, 376, 382
 purity, 308, 314
 sucrose extracted from, 333-342
 sulphitation of, 238
 utilisation of, 375-378
 net and gross weights of roots, 18
 nitrogen in, 139-141
 pulp (*see Pulp*)
 seed, 12
 production of, 15-17
 selection of, 14-15
 slicers, 80-82
 sugar, varieties of raw, 390
 varieties of, 13-15
 vinasse, 378-382
yield of roots per acre, 18, 26
 sugar per acre, 26
- BETAINE**, from beet-molasses, 381-382
BISULPHITES, 165
BLANKIT, 174
BLEACHING agents, 171-175
BLUEING sugar, 304-305
BOILING, "blank" or "smooth," 286, 311
 mixed *massecuites*, 312-314, 318-320, 401
 point, definition, 243
 modified by dissolved solids, 108, 243, 315
- BOILING point**, modified by pressure, 243
BONE-CHAR, applications of, 172, 228, 388
 cisterns or filters, 388, 393-394
 composition, 393
 granulated, 388
 kilns for burning, 395-397
 revivification, 172, 388, 395-397
 spent or exhausted, 388, 393, 411
 washing, 394-395
- BRASMOSCOPE**, or **Brixometer**, 315-317
BRITISH Thermal Unit, 244
BRIX, Apparent and True, 145
 Saccharometer, 106
 of raw sugars, 148
- BRIXOMETER**, or **Brasmoscope**, 315-317
- CALANDRIA**, 257, 263, 267, 268-269
CALCIUM bicarbonate, 232
 carbonate, 161, 170, 228
 oxalate, 128, 129, 139
 phosphate, 164
 saccharates, 113, 229, 231, 337-341
 salts of organic acids, 173, 193
 sulphite, 183, 185, 191, 194
- CALORIE**, 244
CALORIFIC VALUE of bagasse, 345-346
 of molasses, 366
- CALORIZATOR**, 84
CANE, analysis and composition of, 126, 144
 arrow, 22
 colours of stem, 20
 "crusher," 46
 "cutter," 45
 diffusion process compared with milling, 66
 eye or bud, 21, 22
 -factory by-products, 345
 fibre, 42, 128, 135, 349
 flower or arrow, 22
 gum, 128, 134, 180, 183
juice, air in, 126, 194, 201
 analysis of, 127, 145, 149, 151
 composition, 127, 285
 darkening of, 132
 from separate mill-units, 149, 151
 non-sugars in, 128-137
 purity, 147-149, 151
 leaf, 21
massecuite, 284-285

- CANE-mill (*see Mill*)
molasses, alcohol from, 357,
 358-363
 composition, 308, 356
 exhausted, 324
 fuel value, 365-366
 grain present in, 325
 loss of sucrose in, 324,
 356
 nitrogen in, 356, 368,
 369
 preparation of, 327-
 328
 purity, 308, 314
 solidified, 357, 370-
 371
 sucrose extracted
 from, 336
 utilisation of, 356-371
- nodes, 21
 nomenclature of, 23
 ratoons, 19
 roots, 20, 22
 seed, 23
 seedling canes, 23-26
 shredders, 46
 -sugar, varieties of raw, 389-
 390
 -syrup composition, 285, 409
 purification, 192, 194,
 197
 -tops for planting, 21
 varieties of, 22-26
 -wax, 126, 128, 135, 351, 354-
 355
 yield of canes per acre, 26
 sugar per acre, 26
- CARAMEL, 133, 141
- CARBOHYDRATES, varieties of, 4,
 105
- CARBON, decolourising (*see Decolour-
 ising*)
dioxide, production, 167-170,
 357, 364
- CARBONATION PROCESS, Battelle's, for
 cane-juice, 197, 336
 chemistry of, 228-233
 control of, 232
 double-, of beet-juice,
 197, 233-237
 filter-press cakes, 353-
 354, 374-375
 de Haan's Process,
 196, 197-199
 Harloff's Process, 197
 lime and coke re-
 quired, 168-170,
 198, 229
 single, 197, 231-233
- CARBONATION PROCESS, tanks, 171, 233
 triple, 237
 and sulphitation com-
 pared, 199-209
- CASTOR sugar, 390, 402
- CATECHOL in beet-juice, 139, 141
 in cane-juice, 132
- CELLS of plants, 7, 9
- CENTRIFUGAL force, theory of, 293-
 295
 filtration, 296
 -subsiders, 223-226, 295
 sugar-, 296-301
- CHAR (*see Bone-char*)
- CHEMICAL control of factory, 146-147,
 329
- CHLOROPHYLL in cane-juice, 126, 128,
 130
 in leaves of plants, 4, 8
- CHOLESTEROL in beet-juice, 139, 142
- CIRCULATION OF JUICE in diffusion-
 battery, 89
 in evaporators, 246,
 255
 in juice-heaters, 177,
 178
 in vacuum pans, 268,
 271
- CLAASSEN'S experiments on:—
 diffusion of beet, 95
 supersaturation of beet-
 syrup, 278
 viscosity of sucrose solu-
 tions, 265-266
- CLARIFICATION for raw cane-sugar,
 160, 179-186
 for white cane-sugar,
 190-195
 for yellow cane-
 sugar, 186-189
 French Defecator,
 175-176, 201
 Hatton's Defecator,
 176, 201
 lime required for, 182,
 184, 188, 192, 198
 of cane-syrup, 192,
 194, 197
- CLARIFIERS (*see Subsiders*)
- CLARIFYING AGENTS, lime 160-164
 phosphoric acid,
 164
 sulphur dioxide,
 164
 superphos-
 phates, 164
- CLARINE, 164
- CLARIPHOS, 164
- CLAYING sugar-loaves, 387-388

- COFFEY'S Still, 361-362
 COILS, length of, 269
 short-, 269
 COKE, in lime-kiln, 168-170, 198
 COLCO cattle-food, 369-370
 COLLOIDS, 76, 142
 COLOURING MATTERS of beet-juice,
 139, 140
 of cane-juice, 128, 130-
 133, 183, 190
 CONTROL OF carbonation, 232, 237
 crystallisation, 322-329
 defecation, 182, 185,
 188-189, 194-195
 diffusion of beet, 91-98
 mill work, 146-147
 subsidence, 182
 sulphitation of beet-
 juice, 239
 of cane-juice, 185, 188-
 189, 194-195
 vacuum pan, 315-320
 COOLERS, 286, 290-292
 COOLING at rest, 288-289
 in motion, 289-292
 condensing water, 258
 COPPER-WALL, 160
 CORROSION of boiler-plates and tubes,
 261
 of evaporator-tubes, 166
 COST OF de Haan's Carbonation Pro-
 cess, 199
 Double Carbonation Process,
 199
 Sulphitation Process, 199
 CRUSHER, Krajewski, 46
 CRYSTALLISATION at boiling-point,
 280-286
 during cooling, at
 rest, 288-289
 during cooling, in
 motion, 289-292
 efficiency of, 321-
 329
 retarded, 287-288
 CRYSTALLISERS, 286
 types of, 290-292
 CRYSTALS formation, 275, 276-278,
 280-281
 forms of, 275-276
 growth, 278-279, 281-283
 limit to size, 283
 of fructose, 114
 glucose, 114
 raffinose, 123
 sucrose, 276
 CRYSTAL-SUGAR, 390, 402
 CUBE-SUGAR, 390, 402-406
 machine, 404-406
 CURING, double-, 305
 sugar-crystals, 296-307
 CUSH-CUSH, 126, 206
 CUTTING the Pan, 283
 CYANOGEN, production from beet-
 molasses, 379-380
 DANEK, filter-press, 217, 227
 sand-filter, 212
 DECOLOURISING *agents*, bone-char, 172,
 228
 hydrosulphites,
 174
 sulphur-di-
 oxide, 173
 carbons, Eponit, 172
 Norit, 172
 from filter-
 press cake,
 355
 from molas-
 ses, 371
 DEERK'S *formula for Available*
 Sucrose, 151, 369
 DEFECATION, Deming's Subsider, 203
 effect on cane-juice,
 180
 French defecator, 175-
 176, 201
 Hatton's defecator, 176,
 201
 process for Demerara
 sugar, 186-189
 process for raw cane-
 sugar, 179-186
 temperature for, 180
 tempering cane-juice,
 188
 with sulphitation, 183-
 195
 DE HAAN'S Carbonation Process, 196,
 197-199
 DEHNE'S Filter-press, 217
 DEMERARA sugar, 186-189, 306
 DEMING'S Continuous Subsider, 203
 DESTRUCTIVE DISTILLATION of bag-
 asse, 351-352
 of beet-vinasse, 379-
 380
 DETECTION OF SUGARS by colour re-
 actions, 121
 by optical rotation,
 125
 by phenyl-hydriz-
 inc, 120
 by reduction of met-
 tallic oxides, 119
 DETERIORATION of sugars, 321-322
 DEXTRAN in cane-juice, 134

- DEXTROROTATION**, 108
DEXTROSE (*see Glucose*)
DIALYSIS, 76, 334
DIFFUSERS, 82, 97
DIFFUSION, battery, 77, 82, 89, 97-101
 control of beet-diffusion and efficiency, 91-98
 of beet, 75-79, 89, 97-101, 143
 of cane, compared with milling, 66
 principles of, 75-79
DILUTION OF beet-juice, 96
 cane-juice, 150
DISACCHARIDES, 105, 124
DISTILLATION OF fermented molasses, 359-362
DOMBASLE'S maceration or diffusion of beet, 75, 227
DOUBLE carbonation, 233-237
 curing, 305-306
 filtration, 217
DRIER FOR beet-slices, 373-374
 sugar crystals, 307, 402
DRY SOLIDS %, Apparent and True, 145
DUBRUNFAUT'S Lime-Saccharate Process, 337
 Strontia - Saccharate Process, 341
DUNG from Stock, 357, 369, 382
ÉGOUT, 285, 303
EHRMANNITE, 164
ELECTRIC-DRIVEN centrifugals, 300
 mills, 47
ELIMINATOR, 175, 176
ELUTOR, 337
ENDOSMOSE, 76
ENGINE and gearing of cane-mill, 46
ENTRAINMENT, 261, 323
ENZYMES, invertase, 112-113, 124
 zymase, 112-113
EPONIT, 172
EVAPORATION by multiple-effect, 247-252, 402
 by single-effect, 250-251, 262-265
 formulæ, 252, 271, 285, 318
 in vacuo, 248-252
 under atmospheric pressure, 247
EVAPORATORS, Bulk-, 255, 256-262
 "capacity" of, 251
 cleaning of, 258
 Film-, 255-256
 Lillie, 255
EVAPORATORS, multiple-effect, 247-252, 255-262
 operating, 256-260
 scale in, 247, 258
 single-versus multiple-, 250-251
EXHAUST-STREAM for evaporators, 249
EXOSMOSE, 76
EXTRACTION of commercial sugar, %
 on beet, 26
 of commercial sugar, %
 on cane, 26
 of sucrose, % on sucrose
 in beet, 323
 of sucrose, % on sucrose
 in cane, 57, 323
 of sucrose, % on available sucrose, 151, 326-329
FALSE grain, 278, 281, 289, 302, 304, 311
FEHLING'S copper solution, 119
FERMENTATION of beet-molasses, 376
 of cane-molasses, 357, 359
FERRIC COMPOUNDS in beet-juice, 141
 in cane-juice, 131-133
FERTILIZER made from beet-molasses, 382
 beet-vinasse, 378-381
 cane-molasses, 356, 357, 366-368
 cane-wash, 368-369
 filter-press cake, 353, 375
 furnace-ashes, 349
FIBRE of cane (*see Bagasse*)
FIBRO-VASCULAR tissue, 8, 12, 21
FILM Evaporator, 255-257
FILTERS, Bag-, 209
 Bagasse, 212-213
 Char, 388, 393-394
 Juice, 207
 Kelly, 219-221
 Leaf-, 210, 219-223
 Mechanical, 207
 Philippe, 210-211, 223
 -Press, 213-219, 392
 Sand-, 211-212
 Scum-, 213-223
 Sweetland, 221-223
 Taylor, 209, 393
 Wire-gauze, 208
FILTER-PRESS CAKES from beet-juice, 374-375
 from cane-juice, 353

- FILTER-PRESS CAKES**, loss of sucrose in
(*beet*), 236, 375
loss of sucrose in
(*cane*), 353
steaming, 216
washing, 216
- FILTRATION**, agents added to assist,
205-206, 393
centrifugal, 296
double, 217
kieselguhr, to assist, 205-
206, 393
pressure applied during,
204, 217
principles of, 204-206
stages of, in sugar-fac-
tory, 207
- FINAL MOLASSES** from beet, 308, 376
from cane, 308, 356
definition of, 324
grain in, 325-326
sucrose extracted
from, 333-342
- FLUE GASES**, composition, 346-347
heat lost in, 347
- FODDERS**, beet-molasses, 382-383
beet-pulp, 372-374
beet-treacle, 411
cane-bagasse, 369-370
cane-molasses, 357, 369-370
yeast, 357, 364, 377-378
- FOHEBUR'S filter-press**, 218-219
- FORE-WORKERS**, 305
- FORMALDEHYDE** in plants, 4
- FRENCH Defecator**, 175-176, 201
- FRUCTOSAN**, 115
- FRUCTOSATE**, 336
- FRUCTOSE**, chemical properties, 115-
122
crystals, 114
fermentation, 112
physical properties, 114-
115
refractive indices of solu-
tions, 115
solubility, 114
specific rotatory power, 115
tests for, 119-122
- FRUIT-SUGAR** (*see Fructose*)
- FUEL VALUE** of cane-bagasse, 345-346
of cane-molasses, 365-
366
- FURNACES**, bagasse-, 349
char-, 395-397
molasses-, 366
sulphur-, 165, 166
- FUSEL Oil**, 357, 364
- GALACTOSE**, 105, 124.
- GARTLEY bagasse-filter**, 213
- GEARING** of cane-mill, 46
- GEERLIGS**, 130, 132, 135, 150, 169,
196, 199, 209, 211, 290,
310, 314, 324, 333, 349,
353
and Hamaker's Process, 69
schemes for boiling,
"Mixed Massecuties"
314
theory of molasses-for-
mation, 308, 324
- GHUR**, 159, 390
- GLUCINIC acid**, 117, 129, 133, 139, 141
- GLUCOSAN**, 115
- GLUCOSATE**, 336
- GLUCOSAZONE**, 121
- GLUCOSE**, chemical properties, 115-122
-coefficient, 150, 151
crystals, 114
fermentation, 112
physical properties, 114-115
-Quotient, 148
-Ratio to Ash, 150
refractive indices of solutions,
115
solubility, 114
specific rotatory power, 115
tests for, 119-122
- GLYCERIN** from beet-vinasse, 381
from cane-wash, 357, 364-
365
- GOLDEN Bloom**, 407
Syrup, 407, 408-409
- GRAIN**, false-, 278, 281, 289, 302, 304,
311
formation of, 276-278, 280-
281
growth, 278-279, 281-283
-ing point, 280
in final molasses, 325-326
number of, 280-281
seed-, 310, 311
true-, 282
- GRANULATED SUGAR** from beet, 307,
391, 406, 410
from cane, 307
refined, 390, 402
- GRANULATOR**, 402
- GRAPE-SUGAR** (*see Glucose*)
- GROSS AND NET** calorific values, 345,
348
weights of beets, 18
- GUM** in cane, 128, 134, 180, 183
- DE HAAN'S** Carbonation Process, 196
197-199
- HAMAKER'S** and Geerligs' Process, 69
- HARLOFF'S** Carbonation Process, 197

- HATTON'S Defecator, 176, 201
 HEAT, *action on* cane-juice, 175
 glucose and fructose,
 115
 sucrose, 108
 available-, 346
 latent-, 245
 losses during evaporation, 260-
 262
 specific-, 244
 total-, 245
 transmission of, 245-247, 267-
 268
 -Units, 244
 HEATING, Apparatus for, 175-178, 193,
 245, 401
 by multiple-effect, 252-253,
 265
 -surface of evaporators, 245-
 247
 of vacuum pans,
 268-270
 HERSEY cube-sugar machine, 404-406
 HEXOSE sugars, 105
 HIGNETTE'S centrifugal-subsider, 226
 HIND-RENTON mill-grooving, 50
 HINTON-NAUDET Extraction Process
 for cane, 69
 HOWARD Syrup-clairce for sugar-
 loaves, 387
 vacuum pan, 262, 268
 HUCH crystalliser, 292
 HYDRAULIC PRESSURE on filter-presses,
 219
 on mill-rollers,
 48
 HYDRAZONES, 121
 HYDROLYSIS of *raffinose* by acids, 124
 by enzymes,
 124
 of *sucrose* by acids, 110
 by enzymes,
 112
 by heat, 110
 HYDRO-SUCROCARBONATE of lime, 196,
 198, 231
 HYDROSULPHITES, Blankit, 174
 Rédo, 174
 HYGROSCOPIC SALTS in molasses, 322
 ICING-SUGAR, 390
 IMBIBITION, 51
 IMPURITY Quotient, 148-151
 INCONDENSABLE GASES in evaporators,
 246, 259
 INDANTHRENE, 304
 INDICATED sucrose, 151
 INVERSION, 110, 111, 113, 173, 193,
 323, 408
 INVERTASE, 112-113, 124
 INVERT sugar, 122
 IRON COMPOUNDS in beet-juice, 141
 in cane-juice, 131-
 133
 JAGGERY, 159
 JUICE (*see under Beet and Cane*)
 -heater, 175, 176-177
 -superheater, 177-178
 KELLY Leaf-Filter, 219-221
 KETOSE sugars, 118, 120, 121, 124-125
 KIESELGUHR, 191, 205-206, 393
 KILN, char-, 395-397
 lime-, 162, 167-170
 KNIVES of beet-slicers, 80-82
 for preparing cane for milling,
 45
 KOPKE centrifugal-subsider, 226
 KRAJEWSKI Crusher, 46
 KUHLMANN'S Carbonation Process, 227
 LACTIC Acid, 116, 129, 139, 196
 LACTOSE, 4, 124
 LAEVOROTATION, 108
 LATENT heat, 245
 LECITHIN, 139, 142
 LELY'S *formula* for mill-capacity, 55
 for mill-efficiency, 58,
 147
 for mill-performance,
 60, 147
 LEUCONOSTOC mesenterioides, 134
 LEVAN in cane-juice, 134
 LEVULOSE (*see Fructose*)
 LILLIE Evaporator, 255-257
 LIME *action on* fructose and glucose,
 116, 129
 non-sugars in beet-
 juice, 230-231
 non-sugars in cane-
 juice, 180
 sucrose, 111-112
 -cream, 162
 crushed-, 229, 340
 dry-, 162
 impurities in, 161, 236
 -kiln, 162, 167
 saccharate, 113, 229, 231, 337-
 341
 slaked, 161, 229
 -stone, burning of, 168-170
 impurities in, 161
 kilns, 162, 167
 LIMING, cold, 180
 hot, 181
 LIQUOR (refinery), 390, 392
 LITMUS Paper, 182, 186, 188

- LOAF-SUGAR**, 402-406
LOAVES, sugar-, 387-388, 406
LOSS OF heat, 260, 347
 sucrose by entrainment, 323
 by inversion, 323
 in bagasse, 58-61,
 323, 345
 in beet - slices, 92,
 100, 372
 in filter-press cakes
 (*beet*), 236, 374
 in filter-press cakes
 (*cane*), 323, 353
 in molasses (*beet*),
 324, 326, 376
 in molasses (*cane*),
 324, 326, 356
 in refinery, 409-410
 in waste-waters, 372,
 383
 unavoidable, 326
LOW-GRADE SUGARS, remelting in juice,
 310
 used as seed-grain
 309
- MACERATION of beet**, 75
 of cane (*see Saturation*)
- MAGNESIA** in lime and limestone, 161,
 236
- MAIZE plant**, 28
- MALTOSE**, 4, 124
- MANNOSE**, 105, 116
- MAPLE tree and sugar**, 29
- MARC of beet**, 138
- MARGRAFF**, 10
- MASSECUITE**, boiling of mixed-, 312-
 314, 318-320, 401
 composition, 284-285
 cooling at rest and in
 motion, 288-292
 crystals, percentage in,
 285
 from molasses, 285-286,
 289
 from syrup, 284-285,
 287-288
 mixed-, systems of boil-
 ing, 312-314,
 318-320, 401
 theory of, 312-
 313
 mother-liquor in, 285
 viscosity of, 266, 283
- MEGASS** (*see Bagasse*)
- MELIBIOSE**, 124
- MELTING raw sugars**, 390, 392
- MESSCHAERT'S mill-grooving**, 50
- METHYL Phenylsazone**, 121
- METRIC Thermal Unit**, 244
- MILL (cane) capacity**, 55
 versus effici-
 ency, 63-65
 compared with diffusion,
 66-67
 control of work, 146-147
 dry-crushing, 36
 efficiency, 57
 versus capa-
 city, 63-65
 electric-driven, 47
 eleven-roller-, 46
 fourteen-roller-, 46
 gearing and engine, 46
 nine-roller-, 35
 pressure apparatus, hy-
 draulic, 48
 pressure apparatus,
 Toggle, 47
 rollers, grooving of, 48-51
 surface-speed of, 42
 three-roller-, 44
 trash-plate, 44
 unit of multiple-, 44
 wet-crushing, 36
- MIXED MASSECUITES**, calculations,
 317-320
 systems of boiling, 314-
 320, 401
 theory of, 312-313
- MOLASCUIT**, 351, 357, 369-370
- MOLASSES** (*see under Beet and Cane*)
- MOLASSINE**, 369-370, 382
- MONOSACCHARIDES**, 105, 124
- MOTHER-LIQUOR** in massecuite, 285
- MULTIPLE-EFFECT evaporation**, 247-
 252, 402
 heating, 252-253
- MUSCOVADO sugar**, 390
- NAPHTHOL, ALPHA-**, test for sugars,
 121-122
- NATALITE motor-spirit**, 363
- NATURAL varieties of cane**, 22
- NAUDET diffusion process for beet**, 99
 -Hinton process for cane, 69
- NET AND GROSS**, calorific values, 345,
 348
 weights of beets, 18
- NEUTRALISING AGENTS**, carbon di-
 oxide, 170
 phosphoric acid, 164
 sulphur dioxide, 164
- NEWLANDITE**, 164
- NITROGEN compounds** in beet-juice,
 139-140
 beet-molasses, 376, 382
 cane-juice, 128, 129-130

- NITROGEN compounds** in cane-molasses, 356
extraction of, from beet-molasses, 379-381
 in filter-press cake (*beet*), 375
 in filter-press cake (*cane*), 353
 in molasses fodders, 370
 in spent wash (*cane*), 368-369
 in vinasse (*beet*), 378, 379-381
 in yeast, 377-378
- NODES** of cane, 21
- NON-SUGARS** in beet-juice, 139
 in cane-juice, 128
- NORIT**, 172
- NUCLEINS**, 128, 129
- OPTICAL dry-solids** %, 145
 purity, 148
- ORGANIC acids** in beet-juice, 139
 in cane-juice, 128-129
non-sugars in beet-juice, 139-142, 146
 in cane-juice, 128-135, 146
 salts of lime, 173, 193
- OSAZONES**, 121
- OSMOGENE**, 334
- OSMOSIS** of *glycerin* from molasses, 381
 of *sucrose* from beet, 76
 from molasses, 334-335
- OXALIC ACID** in beet-juice, 139
 in cane-juice, 128-129
- OXIDATION** of colouring-matters, 171-172
 of sugars, 119
- OXIDISING agents** for bleaching-juice, 171
- OXYGEN absorption** by juice, 173-174
- OZONE**, 171
- PALMS** for sugar production, 30-31
- PAN** (*see Vacuum Pan*)
- PAPER** from bagasse, 349-351
 parchment-, for dialysis, 76
 test-, 182, 186, 188
- PARENCHYMA tissue**, 8, 12, 21
- PECTIN**, 128, 133, 180, 183
- PECTOSE**, 142
- PELLET**, 314
- PERRICHON Process**, 67
- PHENOLPHTHALEIN** for testing juice, 185, 186, 189, 195, 232
- PHENYLHYDRAZINE**, 120-121
- PHENYLHYDRAZONES**, 121
- PHENYLOSAZONES**, 121
- PHILIPPE Filter**, 210-211
- PHOSPHO-GELOSE**, 191, 194
- PHOSPHORIC ACID** for clarification, 164
 for neutralising, 164
 in bone-char, 393
 in filter-press cake (*beet*), 375
 in filter-press cake (*cane*), 353
 in molasses (*beet*), 376
 in molasses (*cane*), 356
- PISTILS**, 6
- PLANT-cells**, 7, 9
- PLANT**, organs of, 5, 9
 tissues of, 7, 9
- POLARISATION** of juices, syrups, etc., 145
 of sugars, 322-323, 409-410
- POLARISCOPE**, 107, 145
- POLLEN**, 6
- POLYPHENOLS** in beet-juice, 141
 in cane-juice, 132
- POTASH** from beet-molasses, 378-380
 from cane-molasses, 356, 357, 366-369
 from waste-waters, 383
 in beet-molasses, 376
 in beet-vinasse, 378
 in cane-molasses, 356
 in cane-wash, 368
- POTASSIUM CARBONATE**, alkalinity due to, 235
- POT STILL**, for rum, 359-361
- PRE-EVAPORATOR**, 253, 265
- PRESS, Filter-**, 213-219, 392
 Pulp-, 86
- PRESSURE**, hydraulic, on mill-rollers, 48
 on juice during filtration, 204, 217
 Toggle apparatus for mill-rollers, 47
- PROOF Spirit**, 359
- PROOF-STICK**, 264, 280, 281
- PROTOPLASM**, 7, 95, 127
- PUG-MILL**, 288
- PULP (BEET)**, composition, 372
 dry-, 372-374
 -press, 86
 pressed-, 372-373
 sweet-, 372-373
 wet-, 372
- PURGING sugars**, 303
 -syrup, 303, 391, 402, 403, 404
- PURIFICATION** of juice, 160, 161

- PURIFYING AGENTS for juice, 161-171
- PURITY, *Apparent and True*, 148
of beet-juice, 94, 147
 -molasses, 308, 314
of cane-juice, 147, 149, 151
 -molasses, 148, 308, 314
 -syrup, 148
of raw sugars, 148
- PZILLA's cube-sugar machine, 406
- QUARZ sulphitation apparatus, 166
- QUICKLIME, 160
- QUOTIENT, Glucose-, 148, 149, 151
 Glucose-ash, 150, 151
 Impurity-, 148, 149, 151,
 154
 -Inorganic, 154, 155
 -Organic, 154, 155
 of Purity, 147, 149, 151, 154
 -Saline, 154, 155
 Sucrose-, 147, 149, 151, 154
- RADIATION loss of heat by, 261
- RAFFINOSE, chemical properties, 123-
 124
 crystals, 123
 hydrolysis by acids, 124
 physical properties, 123
 refractive indices of solu-
 tions, 123
 solubility, 123
 specific rotatory power,
 123
 tests for, 125
- RAMSEY Macerator, 52
- RATIOS used in beet-sugar factory,
 154
 used in cane-sugar factory,
 148-150
- RATOONS, 19
- RAW sugar (*see Sugar*)
- RÉDO, 174
- REDUCING agents for juice, 171, 173-
 175
 sugars, 120, 124, 126, 127,
 136, 138, 146, 149, 151
- REDUCTION of colouring-matters, 171,
 173
 of cupric oxide, 119
 of silver oxide, 119
- REFINED sugars (*see Sugars*)
- REFRACTIVE INDEX, definition, 106
 of fructose solu-
 tions, 115
 of glucose solu-
 tions, 115
 of juice, 145
 of raffinose solu-
 tions, 123
- REFRACTIVE INDEX of sucrose solu-
 tions, 109
 of syrup, 317
- REHEATERS, 401, 402, 403, 404
- REMELTING of low-grade sugars, 310
- RESORCIN, test for sugars, 121
- RETURN of low-grade sugars to vacuum
 pan, 309-311
- REVIVIFICATION of bone-char, 172,
 388, 395-397
- RILLIEUX's multiple-effect evapora-
 tion, 249, 265
 multiple-effect heating,
 249, 265
- RIND of cane, 20, 21
- ROTATORY Powers (*see Specific Rota-
 tory Power*)
- ROUSSEAU'S Carbonation Process, 75,
 227
- RUM, 357, 362-363
- SACCHARATE, Barium, 337
 Calcium, 113, 229, 231,
 337-341
 Strontium, 113, 341-342
 Processes for extracting
 sucrose from molasses,
 336-342
- SACCHARETIN, 128, 131
- SACCHARIMETER, 107, 145
- SACCHAROMETER (Brix or Balling), 106
- SACCHAROMYCETES, 112
- SACCHAROSE (*see Sucrose*)
- SAND-FILTERS, 211-212
- SAP OF PLANTS, diffusion of, 76
 kinds of, 126-127
- SATURATED solution, 276
- SATURATION of bagasse, 37-42, 51-54,
 60
 compound-, 38, 39, 41
 dilution due to, 150
 double-, 38
 economic limit, 37, 40
 single-, 37, 38
 -water, cold and hot, 41
 -water, percentage added,
 60
 with carbon-dioxide gas,
 235
- SAVE-ALL, 323
- SCALE formation from juice, 129, 139,
 193, 194, 247, 258
- SCHIEBLER'S Saccharate of Lime Pro-
 cess, 337
 Saccharate of Strontium
 Process, 341-342
- SCUM-FILTERS, 213-223
- SEED (beet-), production of, 16
 (cane-), 23

- SEED-GRAIN in vacuum pan, 310, 311
- SEEDLING canes, 23-26
- SELECTION OF BEETS for seed-production, 14
- SELF-EVAPORATION, 245
- SEPARATION PROCESS, Steffen's, 339-340, 411
of crystals from massecuite, 296-298
of lime-precipitate from juice, 201-226
of sugars from each other, 120-121
- SHREDDERS, 46
- SILVER-OXIDE test for reducing sugars, 119
- SKIMMING juice, 159-160, 201
- SLAKED lime, 161
- SLICERS (BEET), disc, 80
knives, 80-82
Maguin, 81
Rasmus, 81
- SODIUM *carbonate*, alkalinity due to, 235
cyanide from beet-molasses, 380
- SOLUBILITY OF calcium sulphite, 185
fructose, 114
glucose, 114
raffinose, 123
saccharates, 113
sucrose, 106, 276-277
- SORGHUM Cane, 28
- SPECIFIC-Heat, 244
Rotatory Power, definition, 107
fructose, 115
glucose, 115
invert sugar, 122
raffinose, 123
sucrose, 107
- SPIRIT, Denatured, 357, 363
Natalite, 357, 363
Proof, 359
- STAMEN, 6
- STANNOUS CHLORIDE for yellow sugar, 187
- STARCH in sugar-cane, 135
- STEAM, exhaust-, for evaporation, 249, 255
juice-, for heating and evaporation, 252, 253
latent heat of, 245
total heat of, 245
- STREAMING of filter-presses, 216, 235
sugar in centrifugals, 303-304, 307
vacuum pan, 264
- STEFFEN'S Lime-saccharate Process, 338
Separation Process, 339-341, 411
- STIGMA, 6
- STILL, Coffey's Continuous Still, 361-362
Pot- or Vat-, 359-361
- STRONTIUM carbonate, 342
hydroxide, 342
saccharate, 113, 341
Saccharate Process, 341, 342
- SUBSIDERS, centrifugal-, 223-226, 295
continuous-, 203
Deming's, 203
gravity-, 202
intermittent-, 202
- SUCROSE, available, 151-154, 326-329
boiling-point of solutions, 109
chemical properties, 108-113
crystals, 276
dialysis, 76
fermentation, 113
hydrolysis by acids, 110
by heat, 110
by invertase, 112
inversion (*see Hydrolysis*)
losses of (*see Losses*)
melting-point, 109
per cent in bagasse, 345
beet, 26, 138, 144
cane, 26, 126, 144
filter-press cake (*beet*), 236, 375
filter-press cake (*cane*), 353
molasses (*beet*), 376
molasses (*cane*), 356
treacle, 409, 410
physical properties, 106-109
Quotient, 147, 149, 151
refractive indices of solutions, 106, 109
solubility, 106, 276-277
specific gravities of solutions, 106, 109
specific rotatory power, 106-108, 109
tests for, 122, 125
viscosity of solutions, 265-266
- SUGARS, classification of, 105
driers, 307, 402
raw, affining of, 390-392, 407
Demerara crystals, 186-189, 306
deterioration, 321-322

- SUGARS, *raw*, granulated beet-, 391, 406, 410
 jaggery, 159
 molasses-, 309, 310
 muscovado, 390
 "Plantation Refined," 305
 "Plantation White," 305
 white granulated beet-, 391, 406, 410
 yellow crystals, 186-189, 306
refined candy, 276
 castor, 390, 402
 crystal, 390, 402
 cube, 390, 402-406
 granulated, 390, 402
 icing, 390
 loaf, 402-406
 soft-pieces, 390, 408
 sugar-loaves, 387-388, 406
 yellow crystals, 407
- SULPHITATION, Aulard's Process for beet-juice, 238, 239
 Bach's Process for cane-juice, 192
 continuous-, 166, 193
 control of, 185, 189, 192, 194, 195
 intermittent-, 167
 of beet-juice, 237-239
 of beet-syrup, 238
 of cane-juice (*acid*), 190-195
 of cane-juice (*neutral*), 183-186
 of cane-syrup, 192
 versus Carbonation, 199-200
- SULPHITE OF CALCIUM, solubility, 185
- SULPHUR Box, 166, 184, 186
 dioxide (gas), 165
 (liquid), 164
 bleaching action, 173, 190-191, 239
 furnace, 165, 166
 quantity required, 165
 Quarez Apparatus, 166
- SUPERHEATING of juice, 175, 177-178
- SUPERPHOSPHATES for clarification, 164
- SUPERSATURATION, coefficient of, 277-279, 281, 287, 317
 control of, 315-317
 degree of, 277
 methods of producing, 276-279
- SWEETLAND Leaf-Filter, 221-223
- SYRUP, *beet*-, bleaching, 238
 filtration, 207, 223
cane-, bleaching, 192
 clarification, 197
 composition, 285
 subsidence, 261
-clairce, 387-388
Golden-, 407, 408-409
Washing-, separation from molasses, 303
- TABLES, Beet and Cane compared, 26
 Beet-seed production, 16
 Beet, varieties of, 14
 Calorific value of bagasse, 346
 Carbohydrates, varieties of, 4, 105
 Composition of beet, 138
 of beet-juice, 138
 of beet-pulp, 372
 of bagasse, 345
 of cane, 126
 of cane-juice, 127
 of filter - press cake (*beet*), 375
 of filter - press cake (*cane*), 353
 of juice from separate mill-units, 149, 151
 of juice, syrup, and *massecuite*, 285
 of molasses (*beet*), 308, 376
 of molasses (*cane*), 308, 356
 of molasses cattle foods, 370
 of treacle and golden syrup, 409
 of *vinasse*, 378
 Control of mill-work, 146-147
 Diffusibility of non-sugars in beet, 143
 Evaporation by Single- and Multiple-effect, 251
 Heating appliances for juice, 175
 Inversion velocities of different acids, 111
 Mill-efficiency, 58
 Mill-performance, 61
 Non-sugars in beet-juice, 139
 in cane-juice, 128

- TABLES**, Physical properties of sucrose, 109
 Sugars, classification of, 105
 Temperatures and vacua in triple-effect, 259
 Vacua in inches and millimetres, 244
 Varieties of beet, 14
 of carbohydrates, 4
 of sugars, 105
 Viscosity of sucrose solutions, 266
 Yield of beet and cane per acre, 26
 Commercial sugar per acre, 26
 Commercial sugar % beet and cane, 26
- TANNINS** in beet-juice, 141
 in cane-juice, 132
- TAPPING SAP** from palms and trees, 31
- TAYLOR Filter**, 209-210, 393
- TEMPERATURE** in carbonation, 196-197, 229
 in crystallisers, 290
 in diffusers, 94-96, 98
 in evaporators, 259
 in vacuum pan, 270, 283, 287, 401
 -Fall in evaporators, 245, 246
 in vacuum pans, 270-271
- TEMPERING** of cane-juice, 188
- TEST-PAPERS**, 182, 186, 188
- TESTS** for aldose sugars, 120-122
 ketose sugars, 120-122
 raffinose, 124
 reducing sugars, 119
 sucrose, 122, 125
- TETRASACCHARIDES**, 105
- THERMAL** units, 244
- TIN** chloride, 187
- TISSUES** of plants, 7
 parenchyma, 8
- TOGGLE** Apparatus, 47
- TOLLEN'S** Silver Reagent, 119
- TRANSMISSION OF HEAT** coefficient, 247, 259, 267
 in evaporators, 250
 in vacuum pans, 267
 retarded by, 246
- TRASH-PLATE**, or -turner, 44
- TREACLE** from raw beet-sugar, 392, 407, 410
 from raw cane-sugar, 392, 409, 410
 raw-, 410
 refined-, 411
- TRIPLE-EFFECT** evaporation, 249, 256-260
 heating, 253
- TRISACCHARIDES**, 105
- TRUE AND APPARENT** dry solids %, 145
 purity, 148
 sucrose %, 146
- UBA** cane, 354
- ULTRAMARINE**, 304-305
- UNAVOIDABLE LOSS** of sucrose, 326
- VACUA**, degrees of, 244
- VACUUM PAN**, calandria-, 263, 267, 269
 capacity of, 268
 coil-, 262, 267, 269
 control of, 315-320
 Express-, 267
 Freitag's, 271
 Greiner's, 269
 Grossé's, 271
 heating-surface, 268-270
 horizontal, 263, 270
 Howard's, 262, 268
 lyre-, 267, 269
 Reboux, 271
 short-coil, 267
 temperature-fall in, 270-271
 Wellner-Jelinek, 270
- VARIETIES** OF beet, 13-15
 cane, 22-26
 carbohydrates, 4, 105
 raw sugar, 389-390
 refined sugar, 390
- VATS**, for fermentation, 358
- VAT-STILL** for rum, 359-360
- VILMORIN**, 13, 14
- VINASSE** composition, 378
 utilisation of, 378-382
- VISCOSITY** of crystallised massecuite, 266, 283
 of molasses, 199, 302
 of sucrose solutions, 199, 265-6
- VIVIEN** Moulds for cube-sugar, 403
 Tube for testing juices, 195, 232
- WASH**, from cane molasses, 357, 358, 368-369
- WASHING** beets, 18
 filter-cloths, 234
 filter-press cakes (*beet*), 234
 filter-press cakes (*cane*), 216, 217
 raw sugars, 303
- WASHING-SYRUPS**, 303, 305

- WATER** for diffusion of beet, 91
 purging sugar, 303
 saturation during milling, 41
- WAX (CANE-) extraction from**
 bagasse, 351
 cane-juice, 355
 filter-press cake, 354-355
- WEIGHTS** in cane-factory, 146
 in beet-factory, 18
- WEINRICH'S Affining Process**, 391
- WEISBERG'S sulphitation of beet-juice**,
 238
- WORT** from cane-molasses, 358
- XANTHINE BASES** in cane and beet-
 juices, 128, 139
- XYLAN**, 128, 134, 180, 183
- XYLOSE**, 134
- YEAST action on fructose and glucose**,
 112
 sucrose, 113, 358
 budding of, 112
 fertiliser, 364, 377
 food from, 364, 377-378
- YELLOW crystals**, 186-189, 407
 dyes, 307, 407
- YIELD OF**, alcohol from beet-molasses,
 376
 cane-molasses,
 358
 beets per acre, 26
 beet sugar per acre, 26
 canes per acre, 26
 cane sugar per acre, 26
 crystals on available su-
 crose, 151, 326-329
 crystals on massecuite, 285,
 290
 raw sugar on available su-
 crose, 153
 beet, 26
 cane, 26
 sucrose in beet or
 cane, 323
 sucrose in juice, 323
 refined sugar % on raw
 sugar, 409-410
- ZYMASE**, 112-113

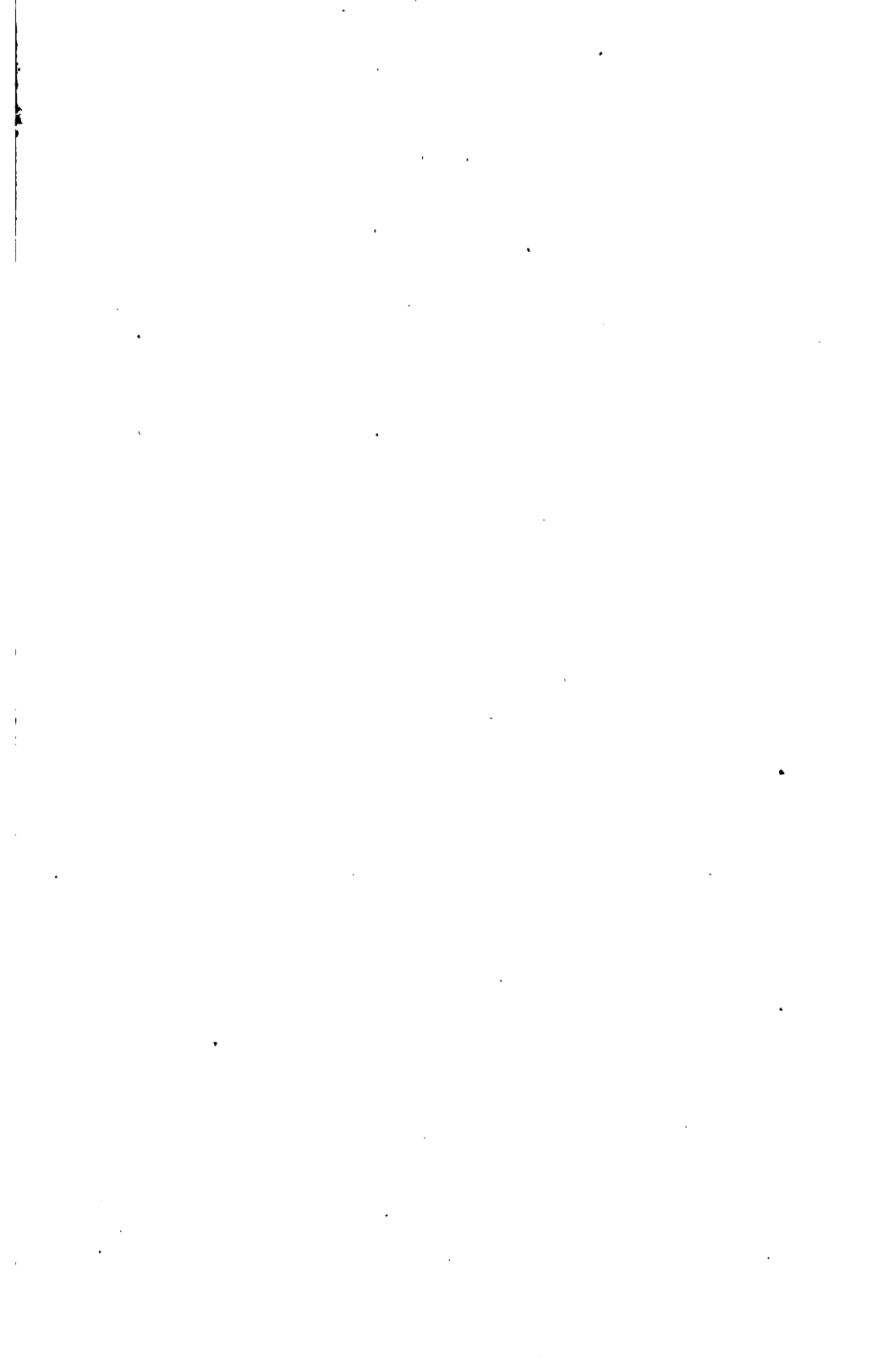



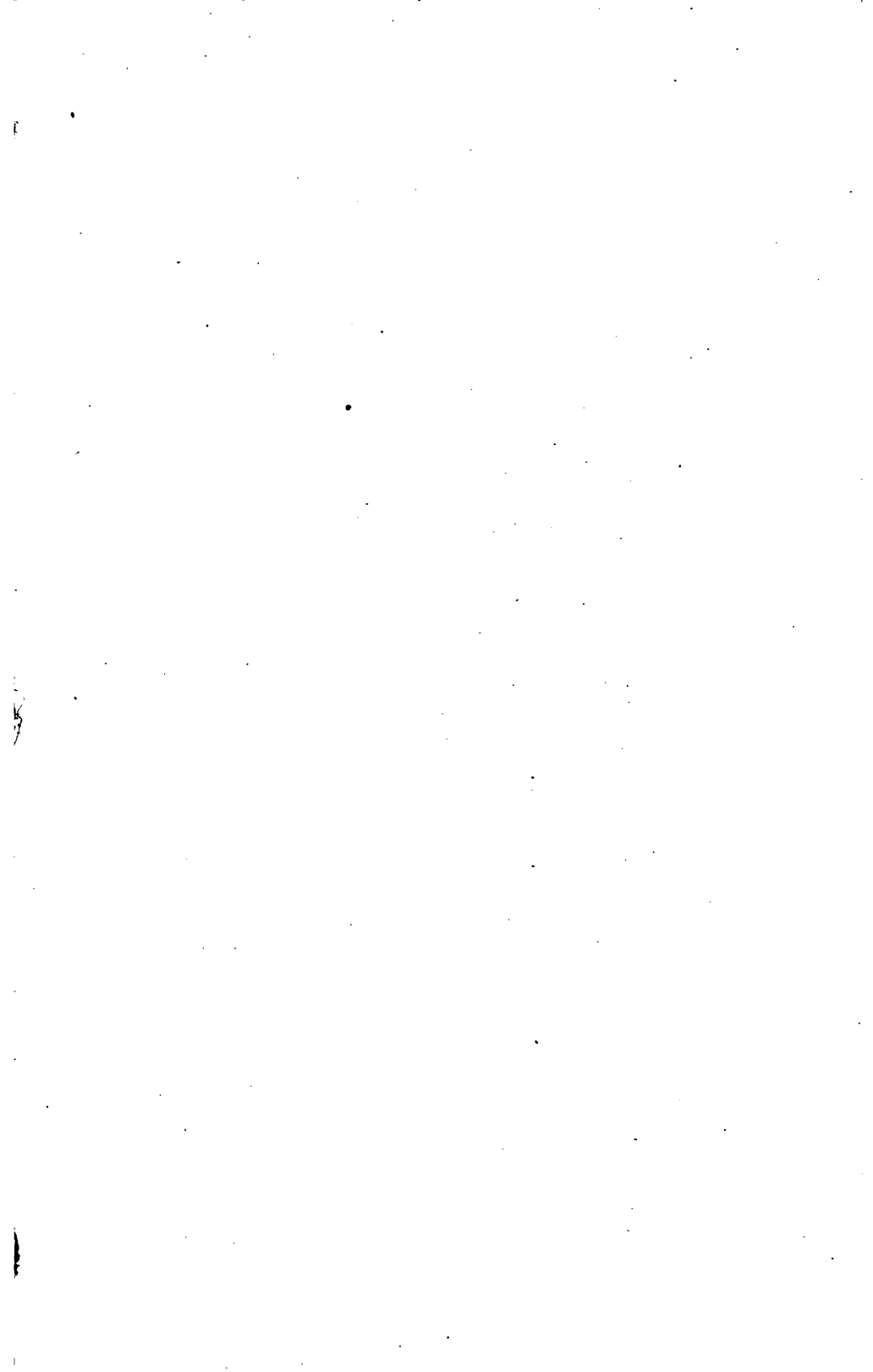

YC 18499

U. C. BERKELEY LIBRARIES



C056080583

435686

TP377

H41

UNIVERSITY OF CALIFORNIA LIBRARY

